

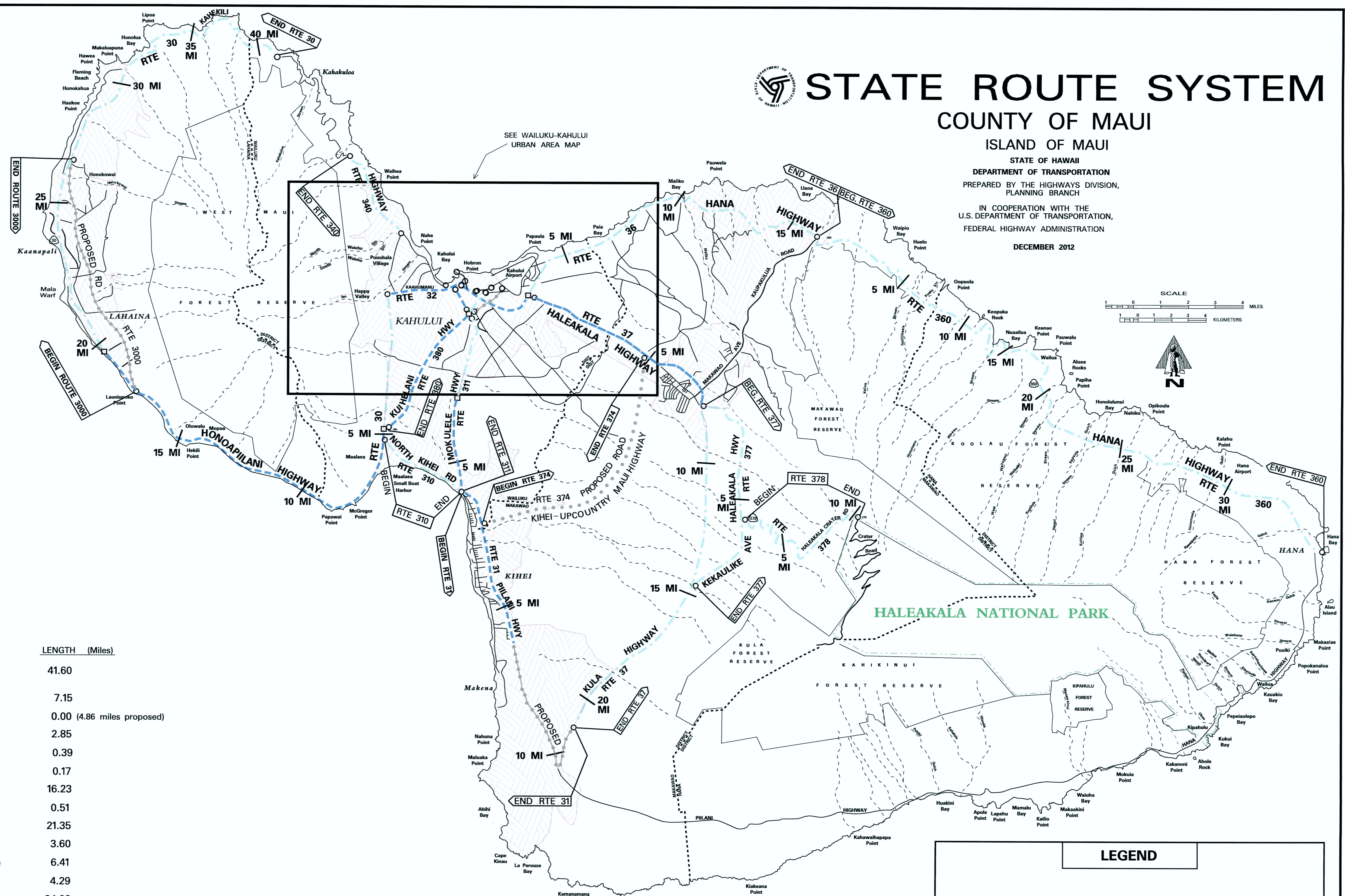

STATE ROUTE SYSTEM

COUNTY OF MAUI

ISLAND OF MAUI
 STATE OF HAWAII
 DEPARTMENT OF TRANSPORTATION
 PREPARED BY THE HIGHWAYS DIVISION,
 PLANNING BRANCH
 IN COOPERATION WITH THE
 U.S. DEPARTMENT OF TRANSPORTATION,
 FEDERAL HIGHWAY ADMINISTRATION
 DECEMBER 2012

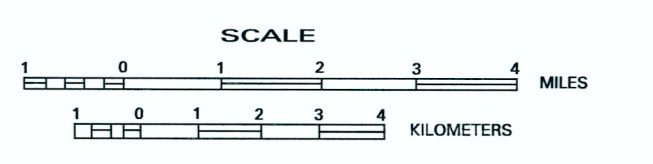

MAUI:

ROUTE	LENGTH (Miles)
* 30 (High St., Honoapiilani Hwy., Kahekili Hwy.)	41.60
* 31 (Piilani Hwy.)	7.15
31 (Piilani Hwy. extension)	0.00 (4.86 miles proposed)
* 32 (Main St., Kaahumanu Ave.)	2.85
* 32A (Hobron St.)	0.39
32B (Wharf St.)	0.17
36 (Hana Hwy.)	16.23
36A (Haleakala Hwy., Keolani Pl.)	0.51
* 37 (Haleakala Hwy., Kula Hwy.)	21.35
310 (North Kihei Rd.)	3.60
311 (Puunene Ave. Mokulele Hwy.)	6.41
340 (Kahekili Hwy.)	4.29
360 (Hana Hwy., Keawa Pl.)	34.93
374 (Kihei-Upcountry Maui Hwy)	0.00 (9.80 mi. proposed No SLD)
377 (Haleakala Hwy., Kekaulike Ave.)	9.17
378 (Haleakala Crater Rd.)	10.15
380 (Dairy Road, Kuihelani Hwy.)	6.18
3000 (Lahaina Bypass)	0.00 (8.95 miles proposed)
3400 (Kahului Beach Rd., Waiehu Beach Rd.)	2.62
3500 (Puunene Ave.)	1.11
3800 (Airport Access Extension)	0.00 (1.67 miles proposed)
MAUI TOTAL	= 168.71

* Please Refer to Hwy System Changes List for Route Changes.

COUNTY OF MAUI:	
	LENGTH (Miles)
MAUI	168.71
MOLOKAI	55.65
LANAI	13.68
TOTAL	238.04

LEGEND

- STATE (NHS)
- STATE (Non-NHS)
- PROPOSED
- PROPOSED (NHS)
- Route termini point
- NHS to non-NHS transition point
- URBAN AREAS

Date Released	Revised
Dec 2002, JK	
Jan 04, DB	
Feb 11, DB	
Feb 12, DB	
Feb 13, CPJ	

DISCLAIMER: This product is for informational purposes only and may not be suitable for legal, engineering, or surveying purposes. This information is provided with the understanding that conclusions drawn from such information are the responsibility of the user. If you feel the information shown on this product is questionable, please contact the State of Hawaii, Highways Division, Planning Branch, at gishelp.hwyp@hawaii.gov or at (808) 587-1841 to report the issue.



STATE ROUTE SYSTEM COUNTY OF MAUI ISLAND OF MAUI

STATE OF HAWAII
DEPARTMENT OF TRANSPORTATION
PREPARED BY THE HIGHWAYS DIVISION, PLANNING BRANCH
IN COOPERATION WITH THE U.S. DEPARTMENT OF TRANSPORTATION,
FEDERAL HIGHWAY ADMINISTRATION
DECEMBER 2012

WAILUKU-KAHULUI URBAN AREA

LEGEND

- STATE (NHS)
- STATE (Non-NHS)
- PROPOSED (NHS)
- Route termini point
- NHS to non-NHS transition point

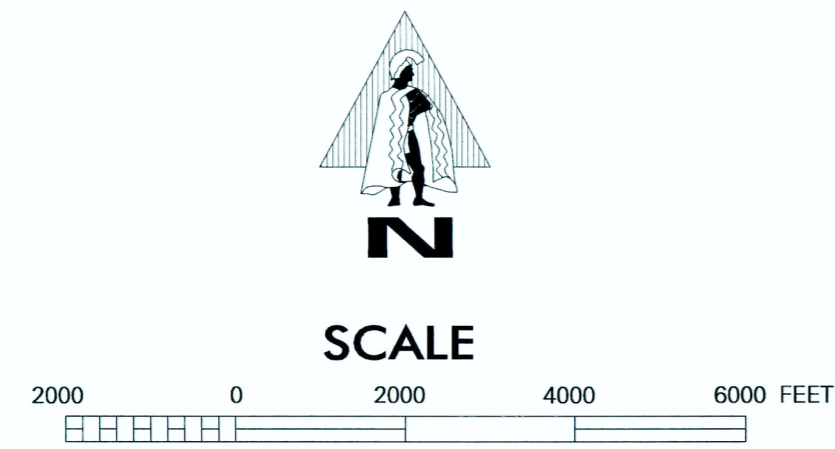

Date Released	Revised
Dec 2002, JK	
Jan 04	DB
Jul 08	DB
Jul 11	DB
Feb 12	DB



STATE ROUTE SYSTEM

COUNTY OF MAUI ISLANDS OF MOLOKAI & LANAI

STATE OF HAWAII
DEPARTMENT OF TRANSPORTATION
PREPARED BY THE HIGHWAYS DIVISION, PLANNING BRANCH
IN COOPERATION WITH THE U.S. DEPARTMENT OF TRANSPORTATION,
FEDERAL HIGHWAY ADMINISTRATION

DECEMBER 2012

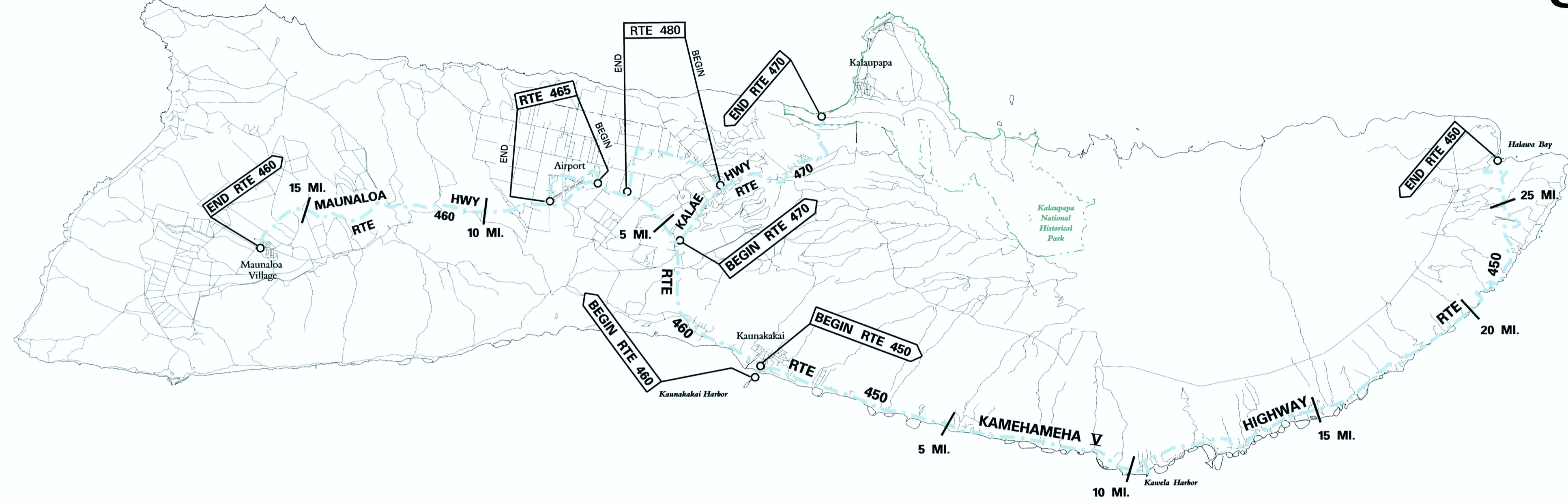

KALOHI CHANNEL

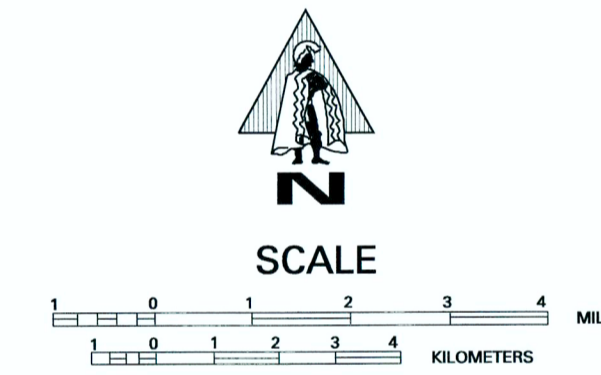

PACIFIC OCEAN

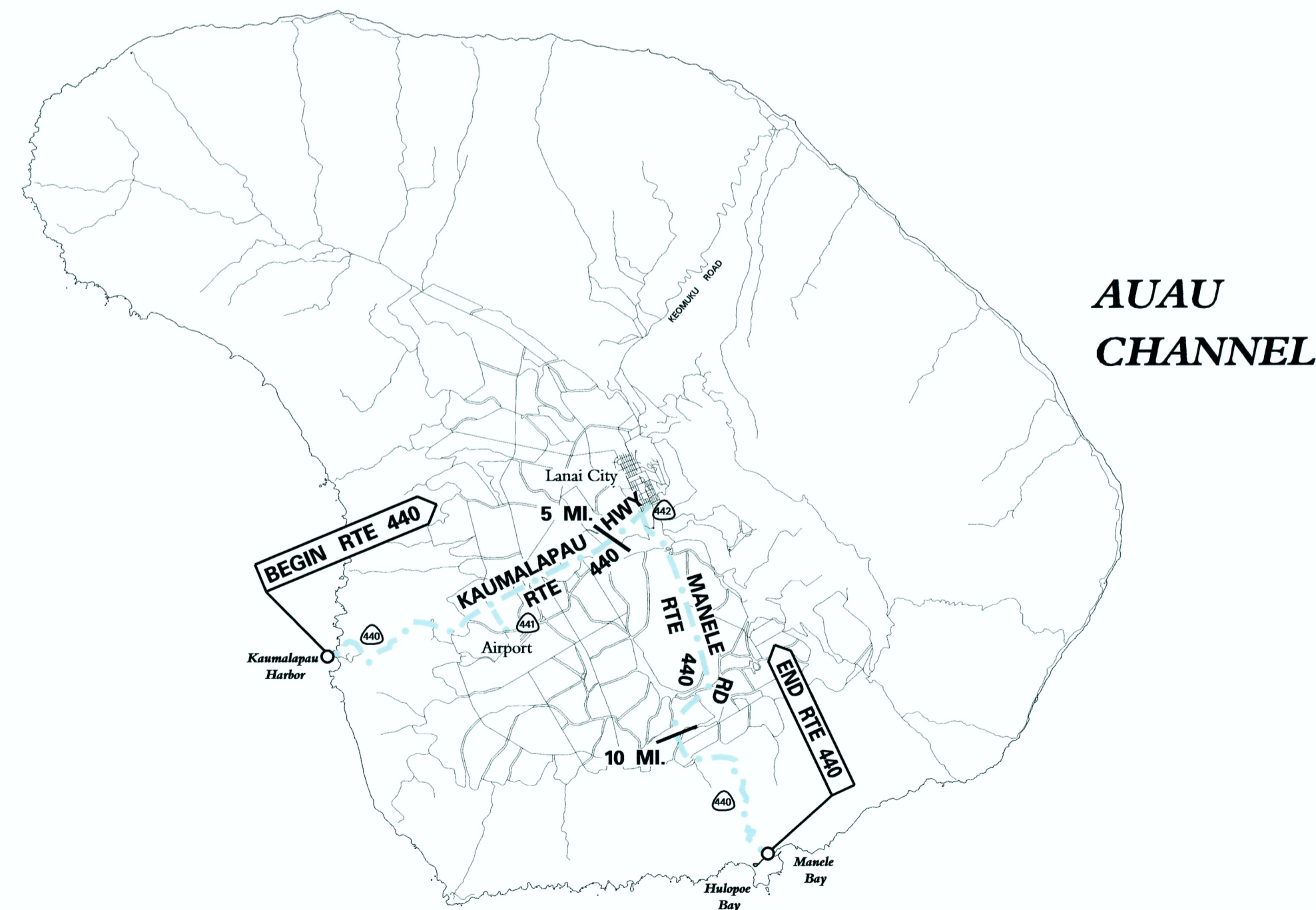

AUAU CHANNEL

ROUTE LENGTH MILES)

MOLOKAI:		
450	Kamehameha V Highway	27.51
*	460 Kaunakakai Pl. & Maunaloa Hwy.	16.56
465	Airport Loop	2.13
470	Kalae Highway	5.79
480	Farrington Ave & Puupeelua Ave	3.66
		MOLOKAI Total = 55.65

LANAI:		
440	Kaumalapau Hwy & Manele Rd.	13.18
441	Access Road to Lanai Airport	0.47
442	Lanai City Spur	0.03
		Lanai Total = 13.68

* Please Refer to Hwy System Changes List for Route Changes.

LEGEND

--- STATE (Non-NHS)

o Route termini point

Date Released	Revised
Dec 2002, JK	

ROAD INVENTORY MAUI RTE 30 HIGH ST. - HONOAPILANI HWY.

STATE OF HAWAII
DEPARTMENT OF TRANSPORTATION
HIGHWAYS DIVISION
PREPARED BY THE
HIGHWAYS PLANNING BRANCH
IN COOPERATION WITH THE
U.S. DEPARTMENT OF TRANSPORTATION
FEDERAL HIGHWAY ADMINISTRATION

Total Route Length: 41.60 miles
 a. Survey Length: 41.60 miles
 b. Proposed Length: 0.00 miles
 c. Other Length: * 0.00 miles

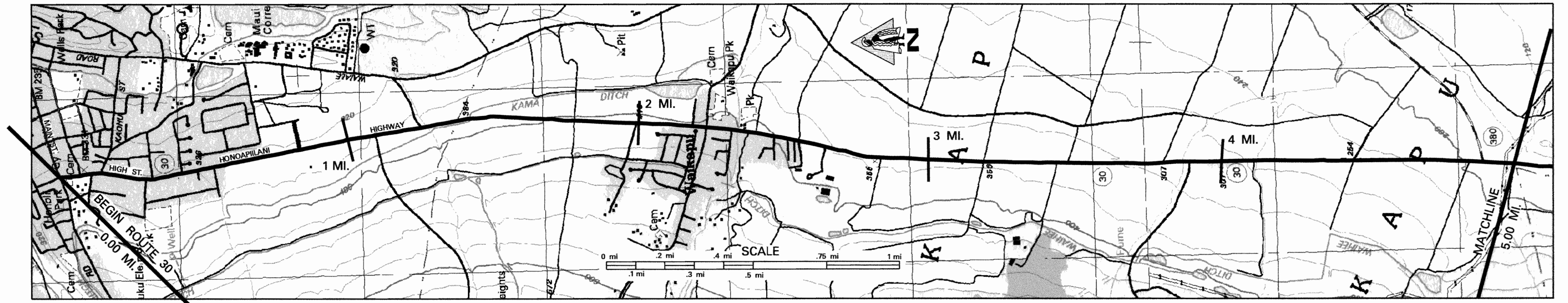

SCALE: (In Miles) 4" = 1 mile

Maintenance Control Sections : Length and Description	30E (0.32MI.)	END 30D - BRGN 30E ON HIGH STREET AT THE SOUTH E.P. OF KAHOOKELE ST.	30D (4.88MI.)
---	---------------	--	---------------

Structure Carrying Road	Bridges (Over 20'): Length, Type, Capacity and Year Constructed	SLAB, 1937, H-15 39'	74' PRE-STRESSED CONC. GIRDER, HS-20-44, 2002
	Vertical Clearance	23'	38' N.B. 36' S.B.
Structure Over Road	Horizontal Clearance	24'	85' - 195'
	Vertical Clearance		
Structure Under Road	Horizontal Clearance		
	Right of Way Width (min.-max.) if varies		
Available Right of Way Width (Needs Study)	1000' Clear, Sugar Cane Field 15' from E.P.	1000' Clear, Sugar Cane Field 25' from E.P.	
Right of Way Fence: Type - Right and Left	None	None	
Control of Access: 1-None, 2-Partial, 3-Full	None	None	
Jurisdiction, Transfer Phase No. and Date (C to S or S to C)	State	State	
Project No., Type of Construction, and Year Constructed	STP-NH-0900(62), RESURF. 2004	30D-01-05, Resurf., 2006	BR-NH-030-1(24), Bridge & Widening, 2002
Project No., Type of Construction, and Year Constructed	HWY-M-02-91M, 2002 (R)	STP-0900(50), Guardrail & Shoulder Imprv., 2002	

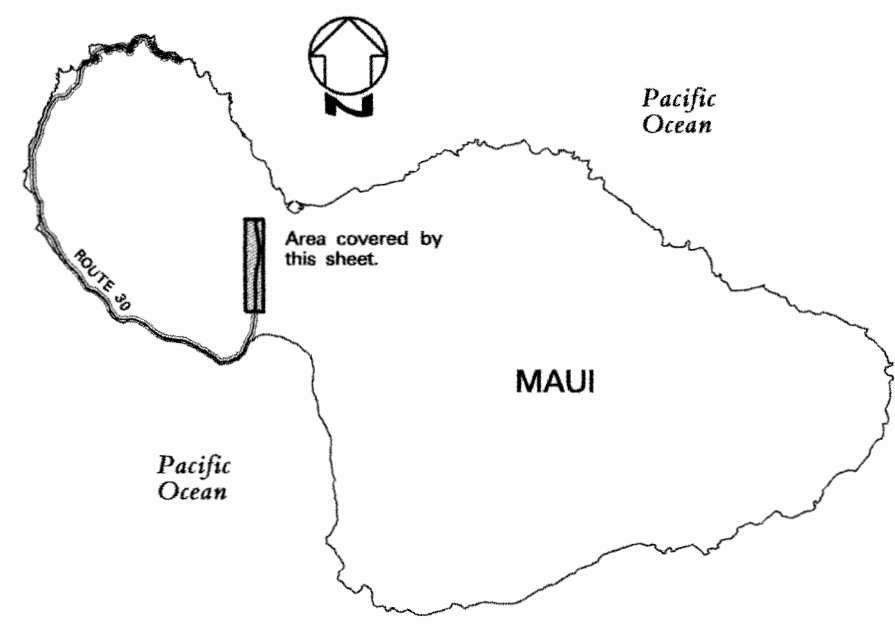

Road Diagram
* MP = Milepost Signage

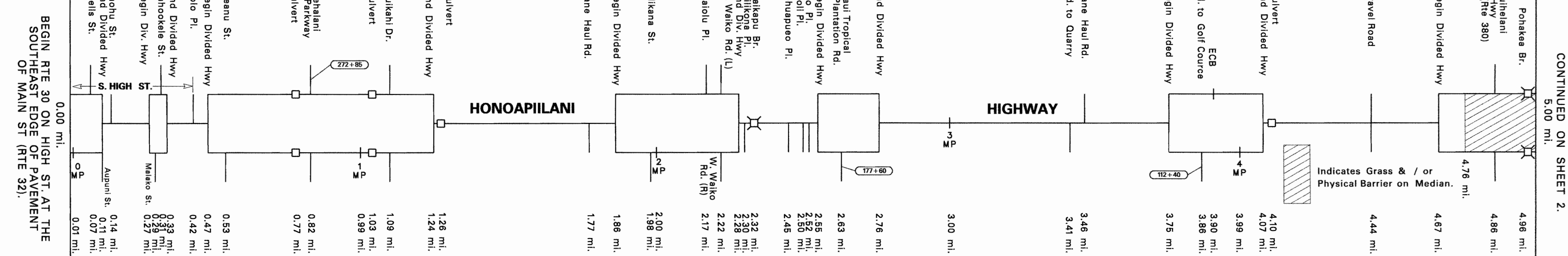

SCALE: (In Miles) 4" = 1 mile

Divided Highway	Shoulder: Width and Type	0-8' AC	4'-6' AC	6' AC	6' AC	6' AC	6' AC	10' AC
	Pavement: Width and Type	12' AC	24' AC	24' AC	24' AC	24' AC	24' AC	24' AC
	Shoulder: Width and Type	0	0	0	0	0	0	0
	Median: Width and Type	0'-8' Paint	0'-12' Paint	0'-12' Paint	0'-12' Paint	0'-12' Paint	0'-12' Paint	0'-12' Paint
Number of Traffic Lanes	Auxiliary Lanes and Parking Lanes: No. of Lanes and Width (Left Side)	0	0	0	0	0	0	0
	(Right Side)	0	0	0	0	0	0	0
	Frontage Road: No. of Lanes, and Width (Right and Left)	0	0	0	0	0	0	0
	Sidewalk: Width and Type (Right and Left)	0	0	0	0	0	0	0
Curb and/or Gutter: Type (Right and Left)	0	0	0	0	0	0	0	
Protective Devices: Type, Location and Number	All Metal Rails on Metal Posts except where indicated.							
Illumination: Type, Location and Number								
Curves: Degree of Curvature (Right and Left)								
Superelevation (Range)								
Grades: % Grade, Positive or Negative								
Vertical Curve: Crest or Sag, Curve Limits								
Area and Development:								
Terrain: 1-Flat, 2-Rolling, 3-Mountainous								
Speed: 1-Design, 2-Posted								
Intersection Control Devices: Type, Location and Cycle Timing								
Traffic Stations (Current Year)								
HPMS Sections - AADT 2011								
HPMS Sections - AADT 2010								
HPMS Sections - AADT 2009								
DOD Sections								
Census Tracts								
Functional Classification								
National Highway System (NHS)								
Previous Projects: Project No., Date and Limits								

SCALE: (In Miles) 4" = 1 mile

Date Released	Aug 2003, D.B.
Revised	
Sept. 04	D.B.
Nov. 06	D.B.
Dec. 09	D.B.
Feb. 11	D.B.
Feb. 12	D.B.
Feb. 13	E.P.F.

ROAD INVENTORY MAUI RTE 30 HONOAPIILANI HWY

STATE OF HAWAII
DEPARTMENT OF TRANSPORTATION
HIGHWAYS DIVISION
PREPARED BY THE
HIGHWAYS PLANNING BRANCH
IN COOPERATION WITH THE
U.S. DEPARTMENT OF TRANSPORTATION
FEDERAL HIGHWAY ADMINISTRATION

Total Route Length: 41.60 miles
a. Survey Length: 41.60 miles
b. Proposed Length: 0.00 miles
c. Other Length: * 0.00 miles

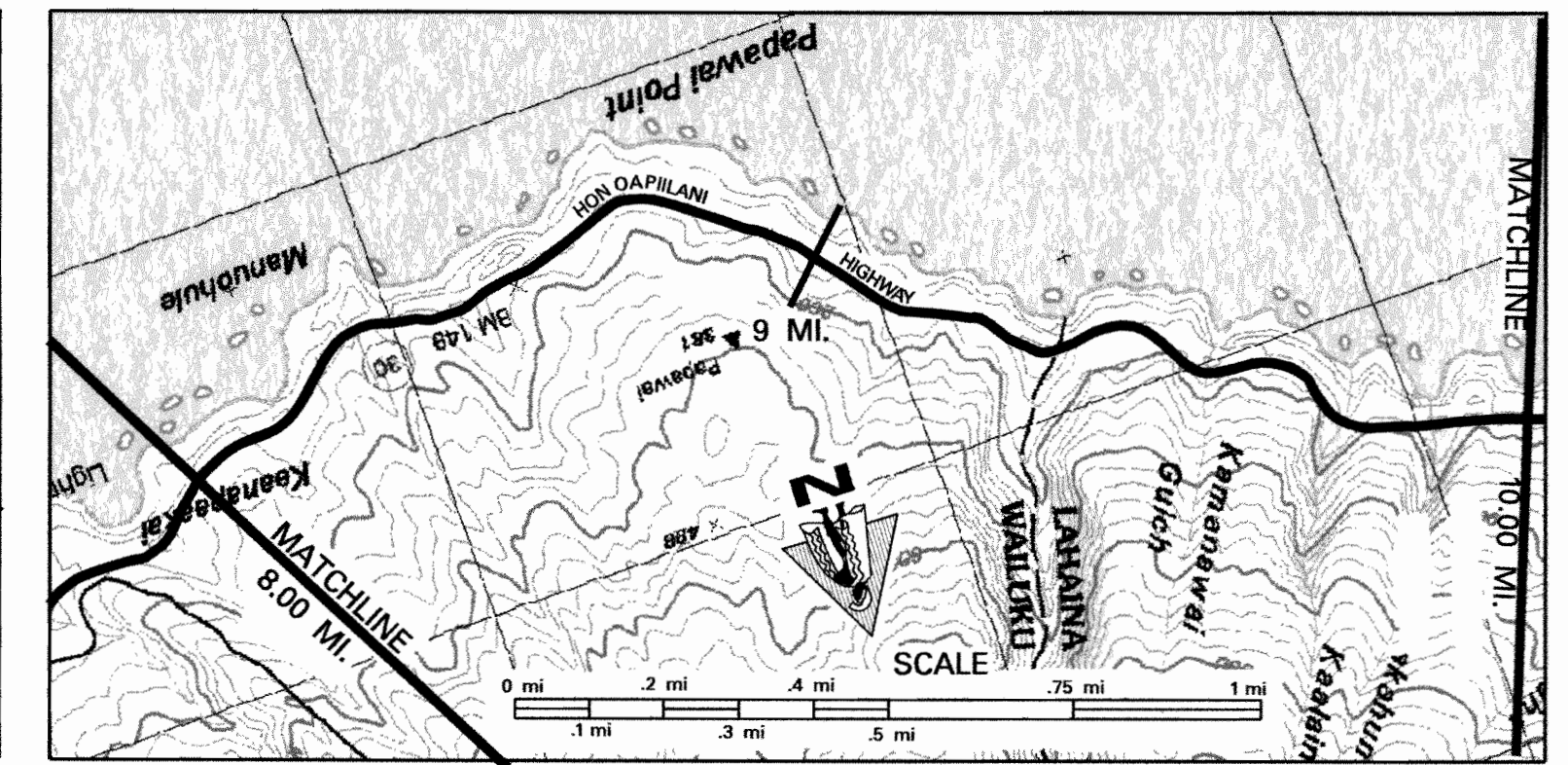
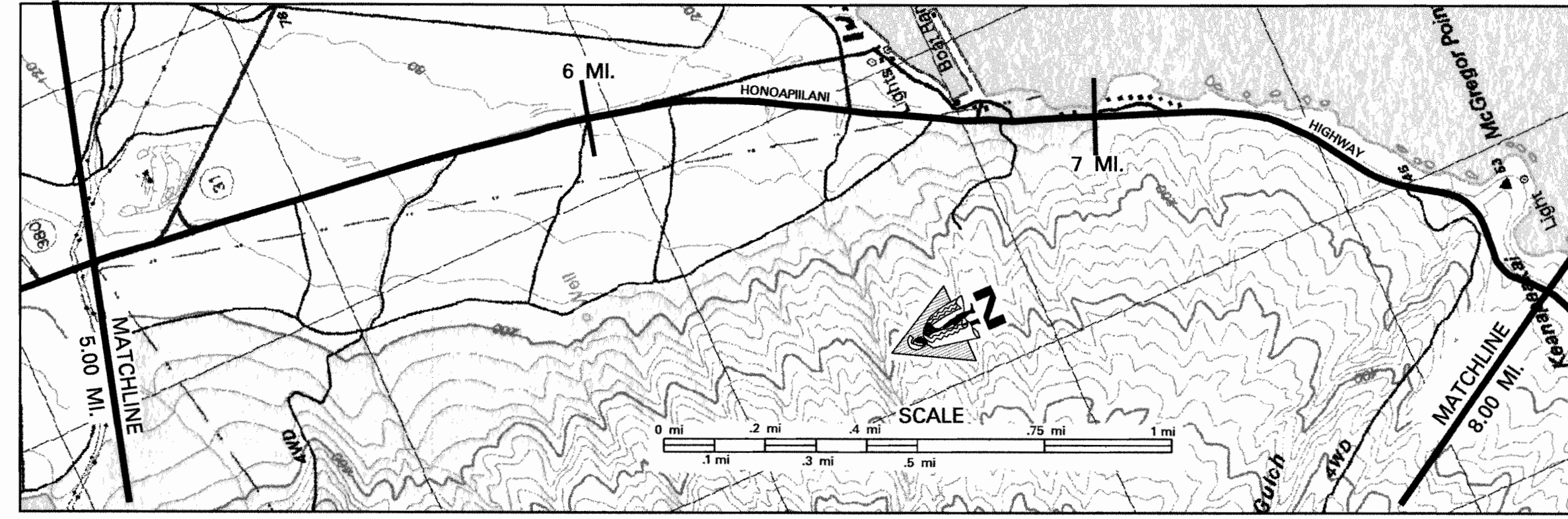

SCALE: (In Miles) 4" = 1 mile

Maintenance Control Sections : Length and Description

Structure Carrying Road	Bridges (Over 20'): Length, Type, Capacity and Year Constructed	30 D (4.88 MI.)	End 30 C - Beg. 30 D on Honoapiilani Hwy 450' South of Projected Centerline Intersection of the North Spur to Kihel Road.	30 C (15.33 MI.)		
	Vertical Clearance					
Structure Over Road	Horizontal Clearance					
	Vertical Clearance					
Right of Way Width (min.-max.) if varies		85' - 195'	160' - 180'	70' - 125'	70' - 160'	120' - 490'
Available Right of Way Width (Needs Study)		1000' Clear, Sugar Cane Field 25' From E.P.	1000' Clear, Pineapple Field, 35' from E.P.	Residential Area	Brush and Trees	
Right of Way Fence: Type - Right and Left		Wire on Wood	Wire on Wood	Wire on Wood	Wire on Wood	None
Control of Access: 1-None, 2-Partial, 3-Full		None	None	None	None	None
Jurisdiction, Transfer Phase No. and Date (C to S or S to C)		State	State	State	State	State
Project No., Type of Construction, and Year Constructed		BR-NH-030-124) Bridge & Widening, 2002	NH-030-1(28), Widening, 2003	STP-0900(53), 2002 Guardrail & Shldr. Imp.	30C-01-88M (R) 1988	ROS-030-114), Imp. 1979
Project No., Type of Construction, and Year Constructed			NH-030-1(25) Resurface 1996			HWY-M-01-99M (R) 2000

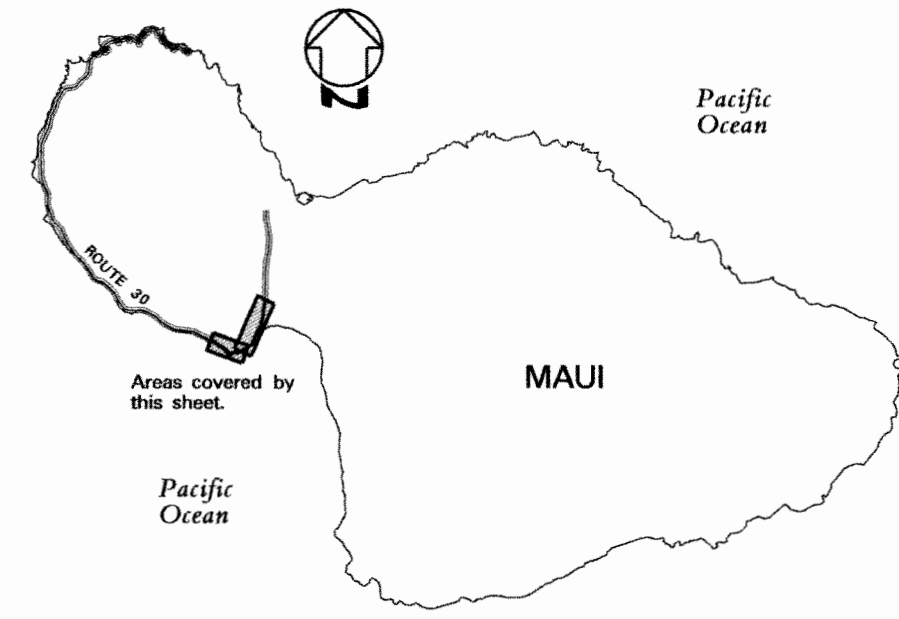

Road Diagram
* MP = Milepost Signage

SCALE: (In Miles) 4" = 1 mile

Divided Highway	Shoulder: Width and Type	(Combination Shldr./Bike Route from 6.83mi. to 20.23mi.)	10' AC	8' AC	4'-6' AC	6'-8' AC	4'-6' AC	6'-8' AC	8'-10' AC	
	Pavement: Width and Type	(Combination Shldr./Bike Route from 6.83mi. to 20.23mi.)	24' AC	12' AC	24' AC	36' AC	24' AC	14' AC	24' AC	
	Median: Width and Type	(Combination Shldr./Bike Route from 6.83mi. to 20.23mi.)	32' Grass	22' Grass	0	0-10' Paint	0	6'-8' AC	0-14' Painted AC	8'-10' AC
	Shoulder: Width and Type	(Combination Shldr./Bike Route from 6.83mi. to 20.23mi.)	4' AC	0	0	0	0	0	14' AC	6'-8' AC
	Pavement: Width and Type	(Combination Shldr./Bike Route from 6.83mi. to 20.23mi.)	8'-10' AC	12' AC	6'-8' AC	6'-8' AC	6'-8' AC	6'-8' AC	6'-8' AC	6'-8' AC
Number of Traffic Lanes		(All 12' TLs.)	4-12'	2-12'	2-12'	2-12'	2-12'	2-14'	2-12'	
Auxiliary Lanes and Parking Lanes: No. of Lanes and Width (Left Side)		(All 12' TLs.)						11' Turn Lane	11' Merge Lane	
Frontage Road: No. of Lanes, and Width (Right and Left)		(All 12' TLs.)								
Sidewalk: Width and Type (Right and Left)		(All 12' TLs.)								
Curb and/or Gutter: Type (Right and Left)		(All 12' TLs.)								
Protective Devices: Type, Location and Number		(All Metal on Metal except where indicated)								
Illumination: Type, Location and Number		(All 12' TLs.)	15 HPS							
Curves: Degree of Curvature (Right and Left)		(All 12' TLs.)								
Superelevation (Range)		(All 12' TLs.)								
Grades: % Grade, Positive or Negative		(All 12' TLs.)	+3							
Vertical Curve: Crest or Sag, Curve Limits		(All 12' TLs.)								
Area and Development:		(All 12' TLs.)								
Terrain: 1-Flat, 2-Rolling, 3-Mountainous		(All 12' TLs.)	Flat (1)					Mountainous (3)		
Speed: 1-Design, 2-Posted		(All 12' TLs.)	45 MPH (2)	45 MPH (2)	45 MPH (Min. 35 MPH) (2)			45 MPH (Min. 35 MPH) (2)		
Intersection Control Devices: Type, Location and Cycle Timing		(All 12' TLs.)								
Traffic Stations (Current Year)		(All 12' TLs.)	874 0030 00488	874 0030 00522				874 0030 00611		
HPMS Sections - AADT 2011		(All 12' TLs.)	24,800	31,081				23,100		
HPMS Sections - AADT 2010		(All 12' TLs.)	25,755	29,393				23,230		
HPMS Sections - AADT 2009		(All 12' TLs.)	25,500	29,102				23,000		
DOD Sections		(All 12' TLs.)								
Census Tracts		(All 12' TLs.)								
Functional Classification		(All 12' TLs.)								
National Highway System (NHS)		(All 12' TLs.)								
Previous Projects: Project No., Date and Limits		(All 12' TLs.)								

SCALE: (In Miles) 4" = 1 mile

Date Released	Aug 2003, D.B.
Revised	
Aug 04	D.B.
Nov 06	D.B.
Mar 09	D.B.
Feb 11	D.B.
Feb 12	D.B.
Feb 13	E.P.J.

ROAD INVENTORY MAUI RTE 30 HONOAPIILANI HWY

STATE OF HAWAII
DEPARTMENT OF TRANSPORTATION
HIGHWAYS DIVISION

PREPARED BY THE
HIGHWAYS PLANNING BRANCH
IN COOPERATION WITH THE
U.S. DEPARTMENT OF TRANSPORTATION
FEDERAL HIGHWAY ADMINISTRATION

Total Route Length: 41.60 miles
a. Survey Length: 41.60 miles
b. Proposed Length: 0.00 miles
c. Other Length: * 0.00 miles

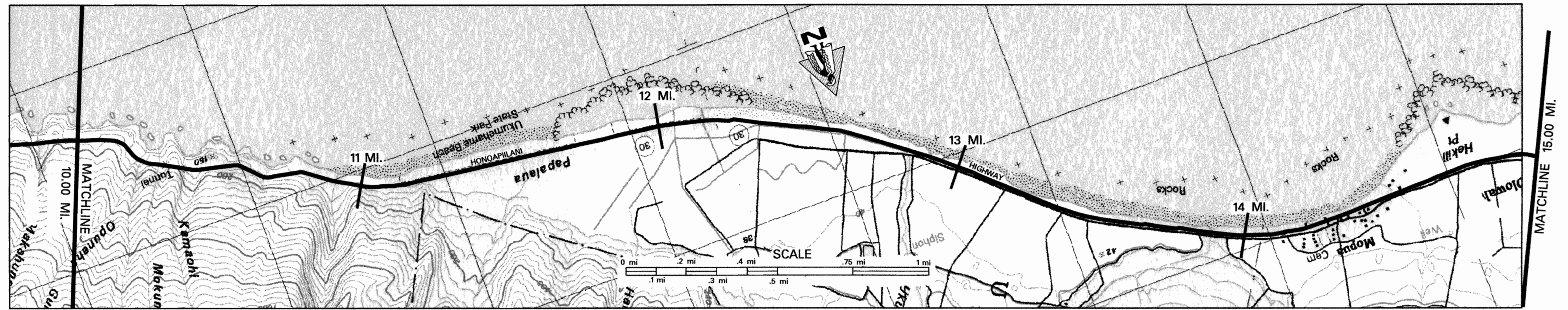

SCALE: (In Miles) 4" = 1 mile

Maintenance Control Sections : Length and Description	30 C (15.33 MI.)
---	------------------

Structure Carrying Road	Bridges (Over 20'): Length, Type, Capacity and Year Constructed	Tunnel 1950	RC Flat Slab H20, 1950				
	Vertical Clearance		12.82'	144'			
Structure Over Road	Horizontal Clearance						
	Vertical Clearance						
Right of Way Width (min.-max.) if varies		(120'-490')					
Available Right of Way Width (Needs Study)		Brush & Trees 80'-345'					
Right of Way Fence: Type - Right and Left		(R) Clear - 40' Canefield (L) Beach					
Control of Access: 1-None, 2-Partial, 3-Full		None					
Jurisdiction, Transfer Phase No. and Date (C to S or S to C)		State					
Project No., Type of Construction, and Year Constructed		STP-0900(53) 2002 Guardrail & Shldr. Imp. HWY-M-01-99M (R), 2000 STP-0900(53), Guardrail & Shoulder Improvements, 2002 (30C-01-06M, Resurf., 2008)					
Project No., Type of Construction, and Year Constructed		(STP-0900(52) Bikeway Imp., 2002)					

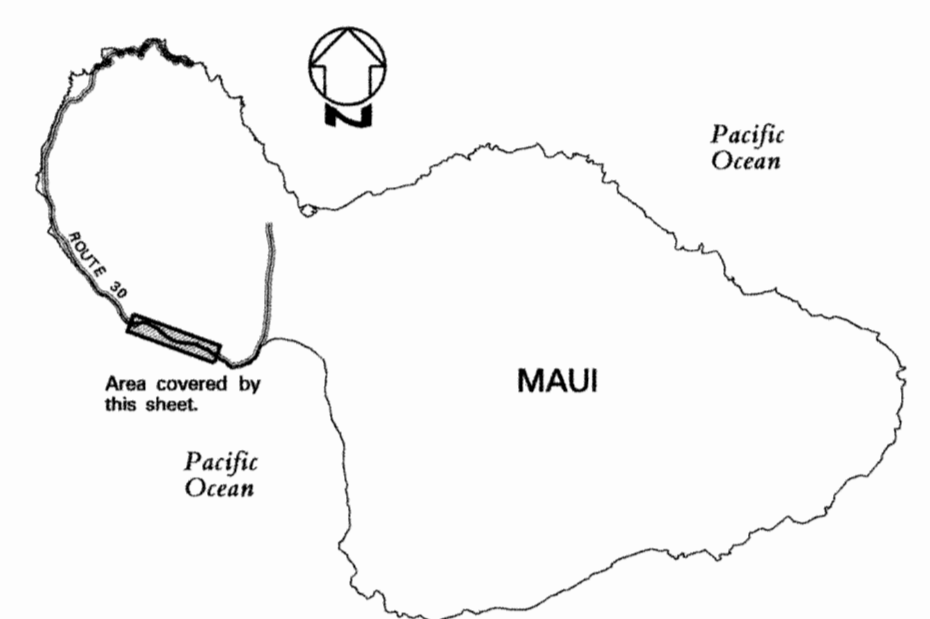

Road Diagram
* MP = Milepost Signage

CONTINUED FROM SHEET 2.

CONTINUED ON SHEET 4.

SCALE: (In Miles) 4" = 1 mile		10	11	12	13	14	15
Divided Highway	Shoulder: Width and Type	(Combination Shldr./Bike Route from 6.83mi. to 20.23mi.)					
	Pavement: Width and Type	8'-10' AC					
	Shoulder: Width and Type	(Combination Shldr./Bike Route from 6.83mi. to 20.23mi.)					
	Pavement: Width and Type	6'-8' AC					
	Median: Width and Type	8'-10' AC					
Undivided Highway	Shoulder: Width and Type	8'-10' AC					
	Pavement: Width and Type	24' AC					
	Shoulder: Width and Type	6' AC					
	Pavement: Width and Type	12' AC					
	Shoulder: Width and Type	6' AC					
Number of Traffic Lanes		2-12'					
Auxiliary Lanes and Parking Lanes: No. of Lanes and Width (Left Side)							
(Right Side)							
Frontage Road: No. of Lanes, and Width (Right and Left)							
Sidewalk: Width and Type (Right and Left)							
Curb and/or Gutter: Type (Right and Left)							
Protective Devices: Type, Location and Number		All Metal Rails on Metal Posts except where otherwise indicated. B = Conc. Barrier					
Illumination: Type, Location and Number							
Curves: Degree of Curvature (Right and Left)							
Superelevation (Range)							
Grades: % Grade, Positive or Negative							
Vertical Curve: Crest or Sag, Curve Limits							
Area and Development:							
Terrain: 1-Flat, 2-Rolling, 3-Mountainous		Mountainous (3)					
Speed: 1-Design, 2-Posted		45 MPH (Minimum 35 MPH) (2)					
Intersection Control Devices: Type, Location and Cycle Timing							
Traffic Stations (Current Year)		874 0030 00611					
HPMS Sections - AADT 2011		23,100					
HPMS Sections - AADT 2010		23,230					
HPMS Sections - AADT 2009		23,000					
DOD Sections							
Census Tracts							
Functional Classification		Principal Arterial (3)					
National Highway System (NHS)		On NHS (1)					
Previous Projects: Project No., Date and Limits		(NH-030-1029) (R) 1996 10.31 10.43 HWY-M-01-99M (R), 2000 30C-01-90M (R) 1990 LT-M-01-78 (R) 1979 10.40 10.46 ROS-030-114) 1979 Safety Imprv. 11.25 11.27 ROS-030-112) 1977 10.48 30C-01-75M (R) 1975 11.27 (F-30(5) 1953) 10.06 276.00 30C-01-75M (R) 1975 11.27 F-30(3) 1950 12.81 F-30(3) 1951 13.82 30C-01-87M (R) 1988 13.81 30C-01-87M (R) 1988 14.61 STP-030-112) (R) 1994 14.62 (RES-STP-030-119) 14.85					

SCALE: (In Miles) 4" = 1 mile

Date Released	Revised
Aug 2003, D.B.	
Aug 04 D.B.	
Nov 06 D.B.	
Mar 09 D.B.	
Dec 09 D.B.	
Feb 11 D.B.	
Feb 12 D.B.	
Feb 13 E.P.J.	

ROAD INVENTORY
MAUI RTE 30
HONOAPIILANI HWY

STATE OF HAWAII
DEPARTMENT OF TRANSPORTATION
HIGHWAYS DIVISION
PREPARED BY THE
HIGHWAYS PLANNING BRANCH
IN COOPERATION WITH THE
U.S. DEPARTMENT OF TRANSPORTATION
FEDERAL HIGHWAY ADMINISTRATION

Total Route Length: 41.60 miles
a. Survey Length: 41.60 miles
b. Proposed Length: 0.00 miles
c. Other Length: * 0.00 miles

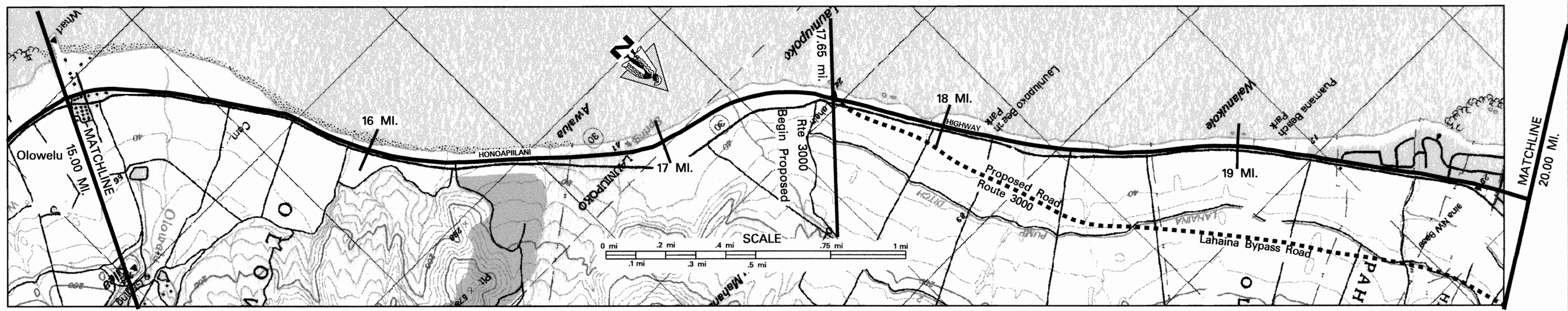

SCALE: (In Miles) 4" = 1 mile

Maintenance Control Sections : Length and Description	15	16	17	18	19	20
Structure Carrying Road	30 C (15.33 MI.)					
Bridges (Over 20'): Length, Type, Capacity and Year Constructed	RC Flat Slab H15, 1938 RC Flat Slab, 1938, H15 RC Flat Slab, 1938, H15 Conc. Slab, 1971, HS 20					
Vertical Clearance	62'					
Horizontal Clearance	24'					
Vertical Clearance	24'					
Horizontal Clearance	24'					
Right of Way Width (min.-max.) if varies	80'-345'					
Available Right of Way Width (Needs Study)	Canefield 1000' Clear - 40' from E.P.					
Right of Way Fence: Type - Right and Left	Trees & Heavy Bushes					
Control of Access: 1-None, 2-Partial, 3-Full	None					
Jurisdiction, Transfer Phase No. and Date (C to S or S to C)	State					
Project No., Type of Construction, and Year Constructed	30C-01-06-M, Resurf., 2008					
Project No., Type of Construction, and Year Constructed	STP-0900(53), Guardrail & Shoulder Improvements, 2002					

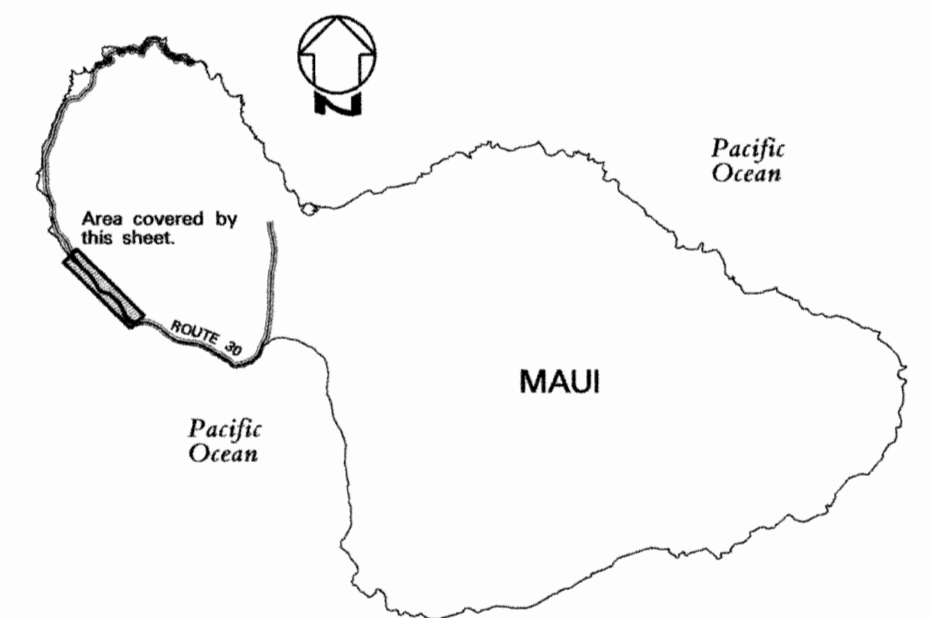

Road Diagram
* MP - Milepost Signage

CONTINUED FROM SHEET 3.

CONTINUED ON SHEET 5.

SCALE: (In Miles) 4" = 1 mile

	15	16	17	18	19	20
Undivided Highway	Shoulder: Width and Type (Combination Shldr/Bike lane from 6.83 mi. to 19.86 mi.) Pavement: Width and Type (Combination Shldr/Bike lane from 6.83 mi. to 19.86 mi.)					
Divided Highway	Shoulder: Width and Type Pavement: Width and Type Median: Width and Type Median Barriers: Shoulder: Width and Type Pavement: Width and Type Shoulder: Width and Type					
Number of Traffic Lanes	2-12'					
Auxiliary Lanes and Parking Lanes: No. of Lanes and Width (Left Side)						
(Right Side)						
Frontage Road: No. of Lanes, and Width (Right and Left)						
Sidewalk: Width and Type (Right and Left)						
Curb and/or Gutter: Type (Right and Left)						
Protective Devices: Type, Location and Number	All Metal Rails on Metal Posts unless otherwise indicated. B = Conc. Barrier					
Illumination: Type, Location and Number						
Curves: Degree of Curvature (Right and Left)						
Superelevation (Range)						
Grades: % Grade, Positive or Negative						
Vertical Curve: Crest or Sag, Curve Limits						
Area and Development:	Rural (99999) Small Urban (99998)					
Terrain: 1-Flat, 2-Rolling, 3-Mountainous	Flat (1)					
Speed: 1-Design, 2-Posted	35 MPH (2) 45 MPH (2) 45 MPH (Minimum 35) (2) 45 MPH (2) 35 MPH (2)					
Intersection Control Devices: Type, Location and Cycle Timing						
Traffic Stations (Current Year)	B74 0030 01388 B74 0030 01765 B74 0030 01969					
HPMS Sections - AADT 2011	28,056 24,700 22,200					
HPMS Sections - AADT 2010	26,533 24,644 25,003					
HPMS Sections - AADT 2009	26,270 24,400 24,755					
DOD Sections						
Census Tracts						
Functional Classification	Principal Arterial (3) On NHS (1) Minor Arterial (4)					
National Highway System (NHS)						
Previous Projects: Project No., Date and Limits	(HES-STP-030-1(191)) STP-030-1(21), R, 1994 STP-030-1(21) (R) 1994 STP-030-1(21) (R) 1994 STP-030-1(21) (R) 1994 STP-030-1(21) (R) 1994 STP-030-1(21) (R) 1994					

SCALE: (In Miles) 4" = 1 mile

Date Released	Revised
Aug 2003, D.B.	Aug 04 D.B.
	Mar 05 D.B.
	Nov 06 D.B.
	Mar 09 D.B.
	Dec 09 D.B.
	Feb 11 D.B.
	Feb 12 D.B.
	Feb 13 E.P.J.

ROAD INVENTORY MAUI RTE 30 HONOAPIILANI HWY

STATE OF HAWAII
DEPARTMENT OF TRANSPORTATION
HIGHWAYS DIVISION
PREPARED BY THE
HIGHWAYS PLANNING BRANCH
IN COOPERATION WITH THE
U.S. DEPARTMENT OF TRANSPORTATION
FEDERAL HIGHWAY ADMINISTRATION

Total Route Length: 41.60 miles
 a. Survey Length: 41.60 miles
 b. Proposed Length: 0.00 miles
 c. Other Length: * 0.00 miles

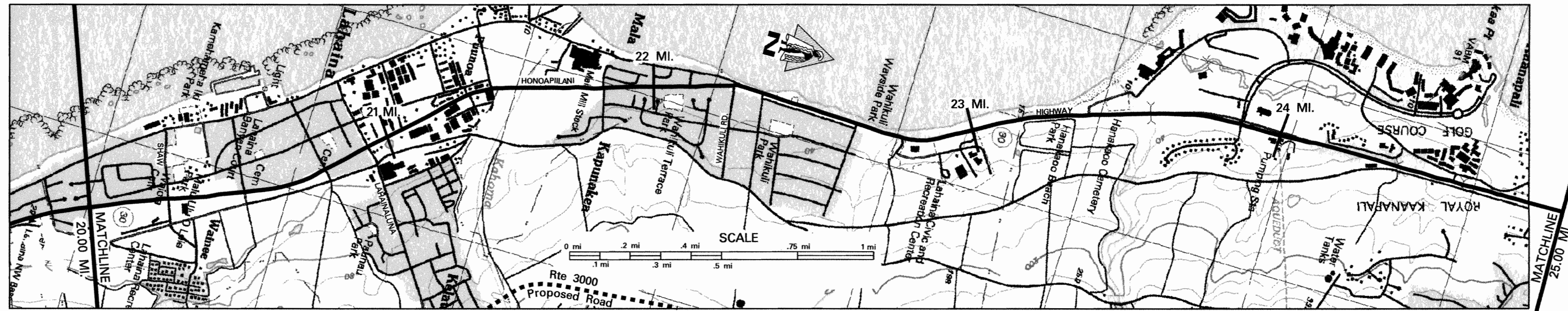

SCALE: (In Miles) 4" = 1 mile

Maintenance Control Sections : Length and Description	20	21	22	23	24	25
	30 C (15.33 Mi.)	End 30 B, Beg 30 C on Honoapiilani Hwy at the centerline intersection with Prison St.	30 B (1.75 Mi.)	End 30 A, Beg 30 B on Honoapiilani Hwy at the centerline intersection with Waihi Rd.	30 A (13.59 Mi.)	

Structure Carrying Road	Bridges (Over 20'): Length, Type, Capacity and Year Constructed	RC Twin Box Culvert, 1957 H 20		Tee Beam 1969		Pre Stressed Concrete Girder HS-20-44, 1969, 1999
	Vertical Clearance	44'		16.8'		16.5'
Structure Under Road	Horizontal Clearance	44'		16.8'		16.5'
	Vertical Clearance	44'		16.8'		16.5'
Right of Way Width (min.-max.) if varies						
Available Right of Way Width (Needs Study)						
Right of Way Fence: Type - Right and Left						
Control of Access: 1-None, 2-Partial, 3-Full						
Jurisdiction, Transfer Phase No. and Date (C to S or S to C)						
Project No., Type of Construction, and Year Constructed						
Project No., Type of Construction, and Year Constructed						

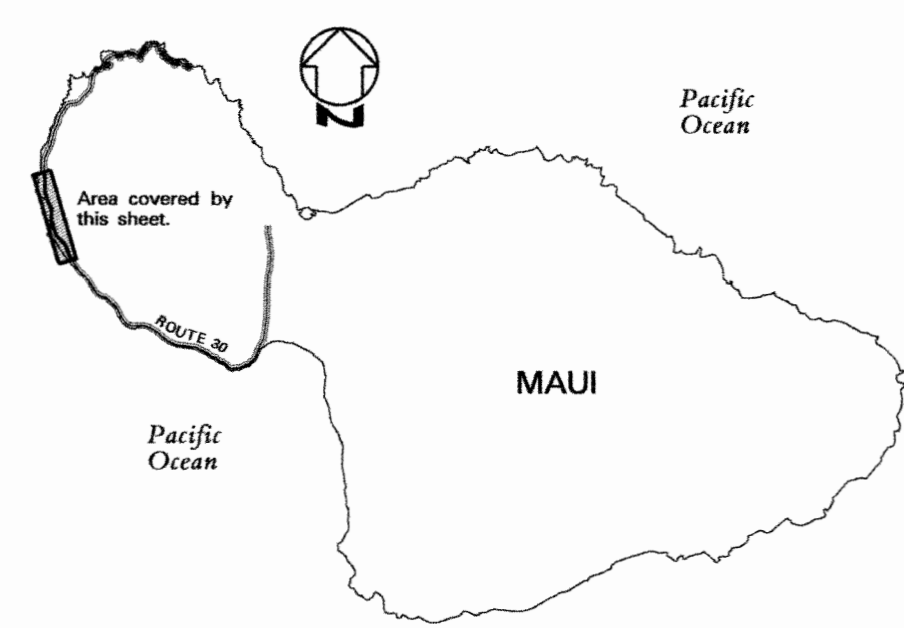

Road Diagram
* MP = Milepost Signage

CONTINUED FROM SHEET 4.

CONTINUED ON SHEET 6.

SCALE: (In Miles) 4" = 1 mile

Undivided Highway	Shoulder: Width and Type	* (Combination Shldr/Bike Route from 6.83 mi. to 19.86 mi., 20.93 mi. to 31.20mi.)					
	Pavement: Width and Type	22' AC					
Divided Highway	Shoulder: Width and Type	* (Combination Shldr/Bike Route from 6.83mi. to 19.86 mi., 20.93 mi. to 31.20mi.)					
	Median: Width and Type	0					
Number of Traffic Lanes							
Auxiliary Lanes and Parking Lanes: No. of Lanes and Width (Left Side)							
Frontage Road: No. of Lanes, and Width (Right and Left)							
Sidewalk: Width and Type (Right and Left)							
Curb and/or Gutter: Type (Right and Left)							
Protective Devices: Type, Location and Number							
Illumination: Type, Location and Number							
Curves: Degree of Curvature (Right and Left)							
Superelevation (Range)							
Grades: % Grade, Positive or Negative							
Vertical Curve: Crest or Sag, Curve Limits							
Area and Development:							
Terrain: 1-Flat, 2-Rolling, 3-Mountainous							
Speed: 1-Design, 2-Posted							
Intersection Control Devices: Type, Location and Cycle Timing							
Traffic Stations (Current Year)							
HPMS Sections - AADT 2011							
HPMS Sections - AADT 2010							
HPMS Sections - AADT 2009							
DOD Sections							
Census Tracts							
Functional Classification							
National Highway System (NHS)							
Previous Projects: Project No., Date and Limits							

SCALE: (In Miles) 4" = 1 mile

Date Released	Aug 2003, D.B.
Revised	
Aug 04	D.B.
Mar 05	D.B.
Nov 06	D.B.
Mar 09	D.B.
Feb 11	D.B.
Feb 12	D.B.
Feb 13	E.P.J.

ROAD INVENTORY MAUI RTE 30 HONOAPIILANI HWY

STATE OF HAWAII
DEPARTMENT OF TRANSPORTATION
HIGHWAYS DIVISION

PREPARED BY THE
HIGHWAYS PLANNING BRANCH
IN COOPERATION WITH THE
U.S. DEPARTMENT OF TRANSPORTATION
FEDERAL HIGHWAY ADMINISTRATION

Total Route Length: 41.60 miles
a. Survey Length: 41.60 miles
b. Proposed Length: 0.00 miles
c. Other Length: * 0.00 miles

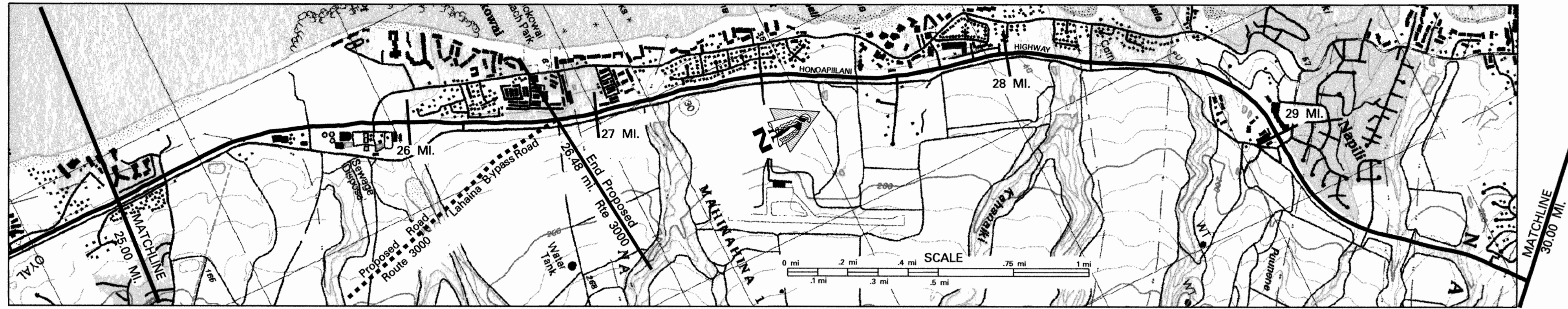

SCALE: (In Miles) 4" = 1 mile

Maintenance Control Sections : Length and Description

Structure Carrying Road	Bridges (Over 20'): Length, Type, Capacity and Year Constructed	
	Vertical Clearance	Horizontal Clearance
Structure	Vertical Clearance	Horizontal Clearance
	Vertical Clearance	Horizontal Clearance

Right of Way Width (min.-max.) if varies	Available Right of Way Width (Needs Study)	Right of Way Fence: Type - Right and Left	Control of Access: 1-None, 2-Partial, 3-Full	Jurisdiction, Transfer Phase No. and Date (C to S or S to C)	Project No., Type of Construction, and Year Constructed	Project No., Type of Construction, and Year Constructed
80'-190'	150'	Chain Link	None	State	STP-030-1(131) Resurf & Widen 1999	STP-030-1(131) Resurf & Widen 1999
75'	75'	Chain Link	None	State	HWY-M-07-07M, Marking and Striping, 2008	HWY-M-07-07M, Marking and Striping, 2008
45'-190'	45'-190'	Chain Link	None	State	30A-01-10M, R, 2012	30A-01-10M, R, 2012
90'	90'	Chain Link	None	State	30A-01-07, Resurf., 2008	30A-01-07, Resurf., 2008
140'-210'	140'-210'	Chain Link	None	State	30A-01-97M, R, 1998	30A-01-97M, R, 1998
230'-320'	230'-320'	Chain Link	None	State	30A-01-97M, R, 1998	30A-01-97M, R, 1998
300'-400'	300'-400'	Chain Link	None	State	30A-01-97M, R, 1998	30A-01-97M, R, 1998

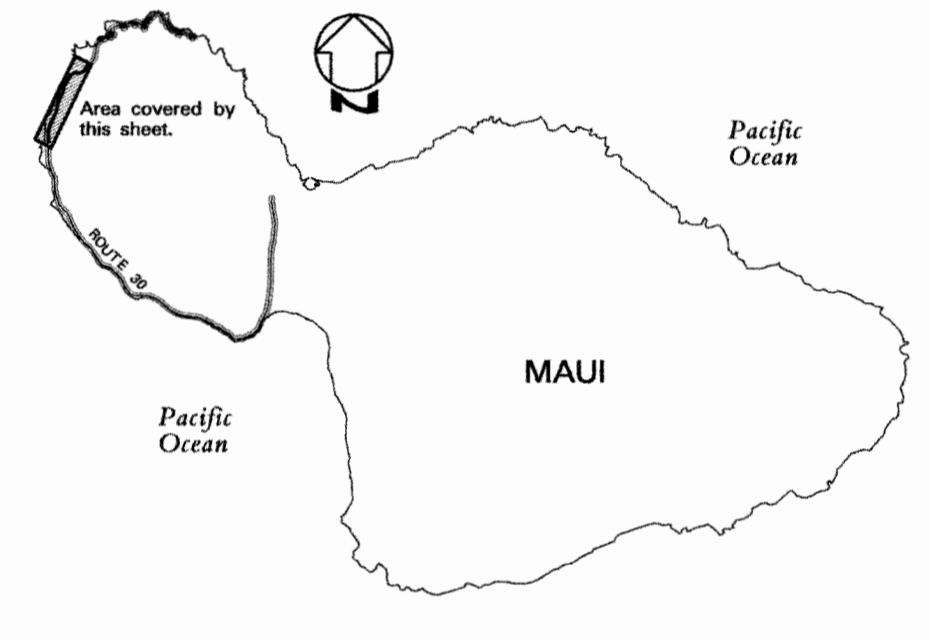

Road Diagram
* MP = Milepost Signage

CONTINUED FROM SHEET 5.

CONTINUED ON SHEET 7.

SCALE: (In Miles) 4" = 1 mile

Shoulder: Width and Type	* (Combination Shldr./Bike Route to 31.20 mi.)									
	Pavement: Width and Type	22' AC	8'-10' AC	24' AC	12' AC	24' AC	12' AC	24' AC	12' AC	24' AC
Median: Width and Type	0	0-15' Painted AC	0	12' Painted AC	0	12' Painted AC	0	12' Painted AC	0	12' Painted AC
Median Barriers:	0	0	0	0	0	0	0	0	0	0
Shoulder: Width and Type	22' AC	6'-8' AC	12' AC	12' AC	12' AC	12' AC	12' AC	12' AC	12' AC	12' AC
Pavement: Width and Type	22' AC	6'-8' AC	12' AC	12' AC	12' AC	12' AC	12' AC	12' AC	12' AC	12' AC
Shoulder: Width and Type	22' AC	6'-8' AC	12' AC	12' AC	12' AC	12' AC	12' AC	12' AC	12' AC	12' AC
Auxiliary Lanes and Parking Lanes: No. of Lanes and Width (Left Side)	4-11'	2-11'	2-11'	2-11'	2-11'	2-11'	2-11'	2-11'	2-11'	2-11'
Frontage Road: No. of Lanes, and Width (Right and Left)	11' T.L.	11' T.L.	11' T.L.	11' T.L.	11' T.L.	11' T.L.	11' T.L.	11' T.L.	11' T.L.	11' T.L.
Sidewalk: Width and Type (Right and Left)	4' Conc. G.	4' Conc. G.	4' Conc. G.	4' Conc. G.	4' Conc. G.	4' Conc. G.	4' Conc. G.	4' Conc. G.	4' Conc. G.	4' Conc. G.
Protective Devices: Type, Location and Number	All Metal Rails on Metal Posts unless otherwise noted.	B-Conc. Barrier	B-Conc. Barrier	B-Conc. Barrier	B-Conc. Barrier	B-Conc. Barrier	B-Conc. Barrier	B-Conc. Barrier	B-Conc. Barrier	B-Conc. Barrier
Grades: % Grade, Positive or Negative	+2									
Vertical Curve: Crest or Sag, Curve Limits										
Area and Development:										
Terrain: 1-Flat, 2-Rolling, 3-Mountainous	Flat (1)									Rolling (2)
Speed: 1-Design, 2-Posted	40 MPH (2)									45 MPH (1)
Intersection Control Devices: Type, Location and Cycle Timing	3 Phase	3 Phase	3 Phase	4 Phase	3 Phase	3 Phase	3 Phase	3 Phase	3 Phase	3 Phase
Traffic Stations (Current Year)	B74 0030 02389	B74 0030 02516	B74 0030 02589	B74 0030 02609	B74 0030 02682	B74 0030 02903	B74 0030 02944			
HPMS Sections - AADT 2011	29,700	29,156	17,600	13,900	14,100	7,600	6,700			
HPMS Sections - AADT 2010	30,704	27,573	20,410	19,798	12,700	8,574	8,574			
HPMS Sections - AADT 2009	30,400	27,300	20,208	19,602	11,600	8,489	8,489			
DOD Sections										
Census Tracts										
Functional Classification				Minor Arterial (4)				Major Collector (5)		
National Highway System (NHS)				NHS diverted to bypass (Proposed Lahaina Bypass is all NHS).				Not On NHS (0)		
Previous Projects: Project No., Date and Limits	30A-01-96M (R) 1997	30A-01-87M & 30A-01-87, 1987	30AB-01-78M Resurf 1978	5-0300(1) 1968	HWY-M-07-07M, Marking and Striping, 2008	STP-030-1(123) Resurf 1996	RF-030-1(7) New Construction, 1977	F-030-1(13) New Construction, 1981	30A-01-97M, R, 1998	F-030-1(8) New Construction 1984

SCALE: (In Miles) 4" = 1 mile

Date Released	Revised
Aug 2003, D.B.	
Aug 04, D.B.	
Mar 05, D.B.	
Nov 06, D.B.	
Mar 09, D.B.	
Feb 11, D.B.	
Feb 12, D.B.	
Feb 13, E.P.J.	

ROAD INVENTORY MAUI RTE 30 HONOAPIILANI HWY

STATE OF HAWAII
DEPARTMENT OF TRANSPORTATION
HIGHWAYS DIVISION

PREPARED BY THE
HIGHWAYS PLANNING BRANCH
IN COOPERATION WITH THE
U.S. DEPARTMENT OF TRANSPORTATION
FEDERAL HIGHWAY ADMINISTRATION

Total Route Length: 41.60 miles
a. Survey Length: 41.60 miles
b. Proposed Length: 0.00 miles
c. Other Length: * 0.00 miles

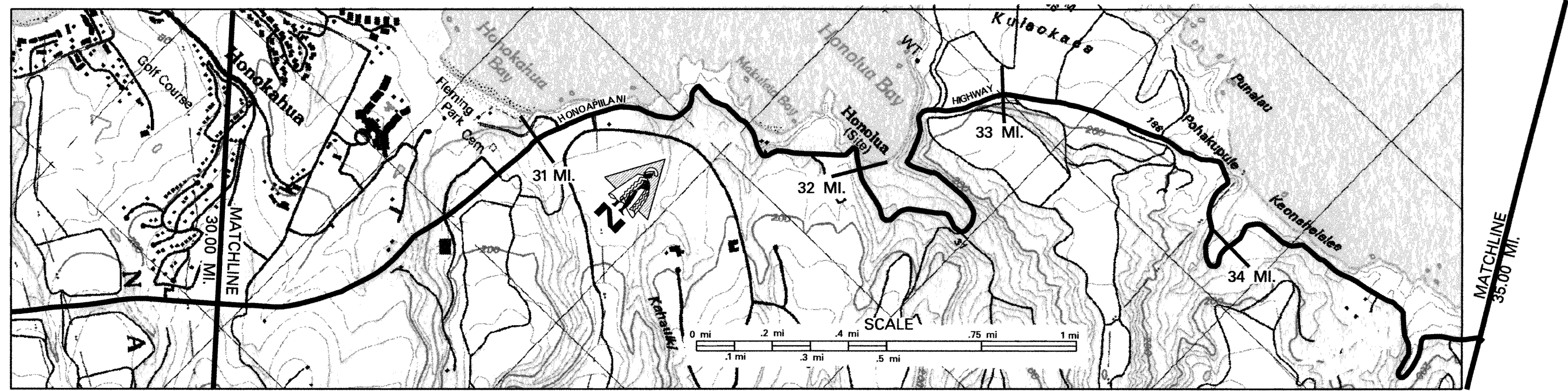

SCALE: (In Miles) 4" = 1 mile

Maintenance Control Sections : Length and Description

Structure Carrying Road	Bridges (Over 20'): Length, Type, Capacity and Year Constructed	30	31	32	33	34	35
Vertical Clearance							
Horizontal Clearance							
Vertical Clearance							
Horizontal Clearance							
Right of Way Width (min.-max.) if varies							
Available Right of Way Width (Needs Study)							
Right of Way Fence: Type - Right and Left							
Control of Access: 1-None, 2-Partial, 3-Full							
Jurisdiction, Transfer Phase No. and Date (C to S or S to C)							
Project No., Type of Construction, and Year Constructed							
Project No., Type of Construction, and Year Constructed							

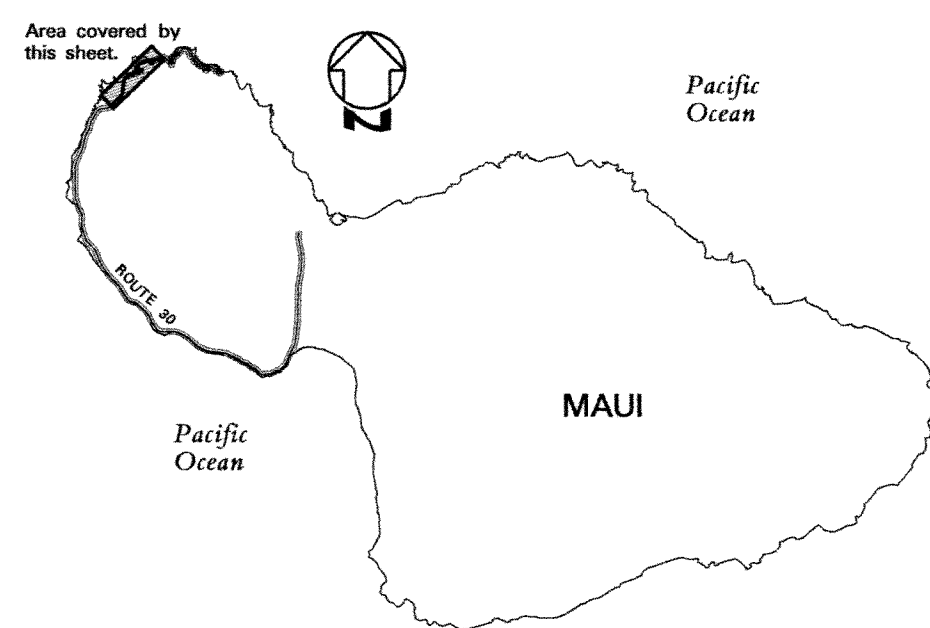

Road Diagram
* MP = Milepost Signage

SCALE: (In Miles) 4" = 1 mile

Divided Highway	Shoulder: Width and Type	30	31	32	33	34	35
Shoulder: Width and Type	*(Combination Shldr./Bike Route to 31.20 mi. - see arrows)						
Pavement: Width and Type							
Shoulder: Width and Type	*(Combination Shldr./Bike Route to 31.20 mi. - see arrows)						
Median: Width and Type							
Median Barriers:							
Shoulder: Width and Type							
Pavement: Width and Type							
Shoulder: Width and Type	*(Combination Shldr./Bike Route to 31.20 mi. - see arrows)						
Number of Traffic Lanes							
Auxiliary Lanes and Parking Lanes: No. of Lanes and Width (Left Side)							
(Right Side)							
Frontage Road: No. of Lanes, and Width (Right and Left)							
Sidewalk: Width and Type (Right and Left)							
Curb and/or Gutter: Type (Right and Left)							
Protective Devices: Type, Location and Number	All Guardrails: Metal Rails on Metal Posts except where otherwise noted. B = Conc. Barrier						
Illumination: Type, Location and Number							
Curves: Degree of Curvature (Right and Left)							
Superelevation (Range)							
Grades: % Grade, Positive or Negative							
Vertical Curve: Crest or Sag, Curve Limits							
Area and Development:							
Terrain: 1-Flat, 2-Rolling, 3-Mountainous							
Speed: 1-Design, 2-Posted							
Intersection Control Devices: Type, Location and Cycle Timing							
Traffic Stations (Current Year)							
HPMS Sections - AADT 2011							
HPMS Sections - AADT 2010							
HPMS Sections - AADT 2009							
DOD Sections							
Census Tracts							
Functional Classification							
National Highway System (NHS)							
Previous Projects: Project No., Date and Limits							

SCALE: (In Miles) 4" = 1 mile

Date Released	Revised
Aug 2003, D.B.	
Aug 04, D.B.	
Mar. 05, D.B.	
Nov. 06, D.B.	
Mar. 09, D.B.	
Dec. 09, D.B.	
Feb. 11, D.B.	
Feb. 12, D.B.	
Feb. 13, E.P.J.	

ROAD INVENTORY MAUI RTE 30 HONOAPIILANI HWY – KAHEKILI HWY

STATE OF HAWAII
DEPARTMENT OF TRANSPORTATION
HIGHWAYS DIVISION
PREPARED BY THE
HIGHWAYS PLANNING BRANCH
IN COOPERATION WITH THE
U.S. DEPARTMENT OF TRANSPORTATION
FEDERAL HIGHWAY ADMINISTRATION

Total Route Length: 41.60 miles
a. Survey Length: 41.60 miles
b. Proposed Length: 0.00 miles
c. Other Length: * 0.00 miles

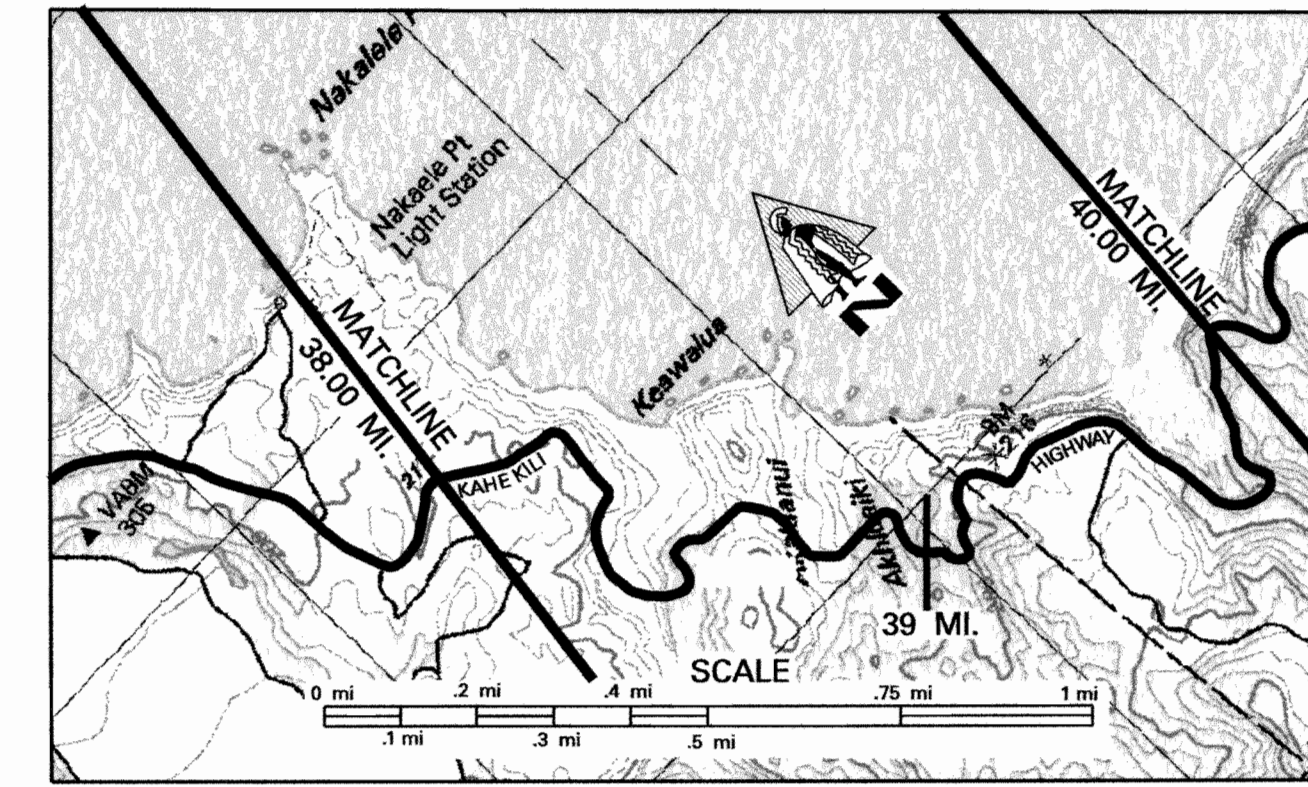
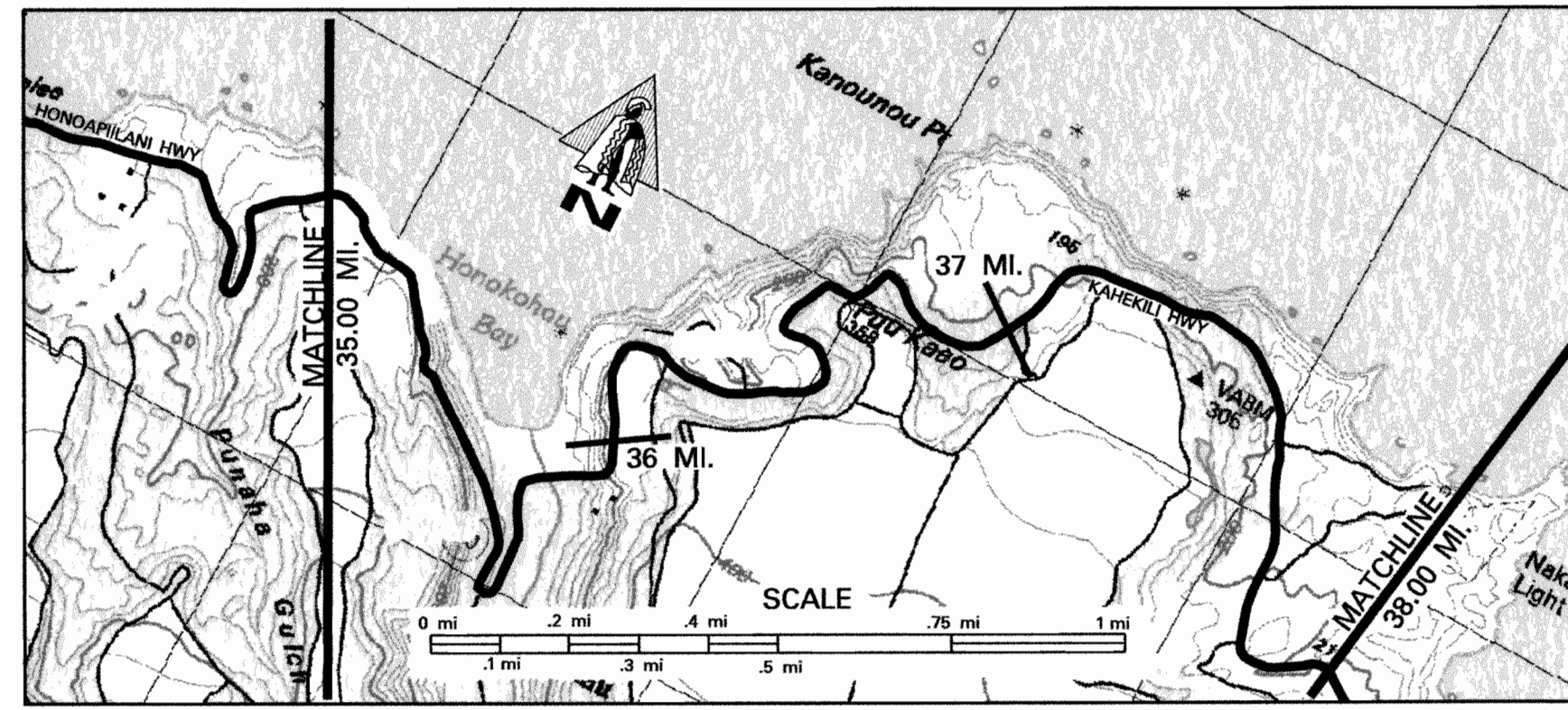

SCALE: (In Miles) 4" = 1 mile

Maintenance Control Sections : Length and Description	35	36	37	38	39	40																																			
Structure Carrying Road	<table border="1" style="width: 100%; border-collapse: collapse;"> <tr> <td style="width: 10%;">Bridges (Over 20'): Length, Type, Capacity and Year Constructed</td> <td colspan="2">Concrete Girder 1924 (1966) HS-20 76'</td> <td colspan="2"></td> <td colspan="2">Timber Stringer 1924 H-10 22'</td> </tr> <tr> <td>Vertical Clearance</td> <td colspan="2">26'</td> <td colspan="2"></td> <td colspan="2">13'</td> </tr> <tr> <td>Horizontal Clearance</td> <td colspan="2"></td> <td colspan="2"></td> <td colspan="2"></td> </tr> <tr> <td>Vertical Clearance</td> <td colspan="2"></td> <td colspan="2"></td> <td colspan="2"></td> </tr> <tr> <td>Horizontal Clearance</td> <td colspan="2"></td> <td colspan="2"></td> <td colspan="2"></td> </tr> </table>						Bridges (Over 20'): Length, Type, Capacity and Year Constructed	Concrete Girder 1924 (1966) HS-20 76'				Timber Stringer 1924 H-10 22'		Vertical Clearance	26'				13'		Horizontal Clearance							Vertical Clearance							Horizontal Clearance						
Bridges (Over 20'): Length, Type, Capacity and Year Constructed	Concrete Girder 1924 (1966) HS-20 76'				Timber Stringer 1924 H-10 22'																																				
Vertical Clearance	26'				13'																																				
Horizontal Clearance																																									
Vertical Clearance																																									
Horizontal Clearance																																									
Right of Way Width (min.-max.) if varies	40'																																								
Available Right of Way Width (Needs Study)	Chain on Wood																																								
Right of Way Fence: Type - Right and Left	Wire on Wood																																								
Control of Access: 1-None, 2-Partial, 3-Full	None																																								
Jurisdiction, Transfer Phase No. and Date (C to S or S to C)	State																																								
Project No., Type of Construction, and Year Constructed	30A-01-91M (R) 1992		340D-01-93M (R) 1994		30A-01-95M (Resurface) 1996																																				
Project No., Type of Construction, and Year Constructed	30A-01-07M, Repairs and Maintenance, 2008																																								

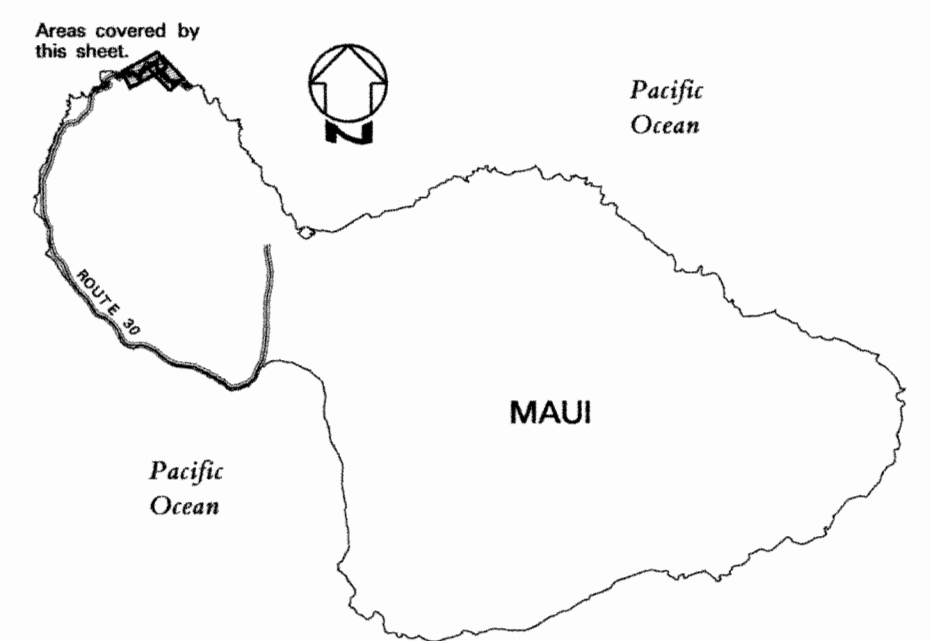

Road Diagram
* MP = Milepost Signage

CONTINUED FROM SHEET 7.

CONTINUED ON SHEET 9.

SCALE: (In Miles) 4" = 1 mile

Divided Highway	35	36	37	38	39	40
Shoulder: Width and Type	2' AC		8'-10' Dirt		2' AC	
Pavement: Width and Type	20' AC		18'-20' AC		20' AC	
Shoulder: Width and Type	2' AC		2' AC/6' Dirt		2' AC	
Median: Width and Type						
Median Barriers:						
Shoulder: Width and Type						
Pavement: Width and Type						
Shoulder: Width and Type						
Number of Traffic Lanes	2-10'		2-(9'-10')		2-10'	
Auxiliary Lanes and Parking Lanes: No. of Lanes and Width (Left Side)						
(Right Side)						
Frontage Road: No. of Lanes, and Width (Right and Left)						
Sidewalk: Width and Type (Right and Left)						
Curb and/or Gutter: Type (Right and Left)	AC Curb		3'-5' AC Gutter		3'-5' AC Gutter	
Protective Devices: Type, Location and Number	All Guardrails Metal Rails on Metal Posts except where otherwise noted. B-Conc. Barrier					
Illumination: Type, Location and Number						
Curves: Degree of Curvature (Right and Left)						
Superelevation (Range)						
Grades: % Grade, Positive or Negative			-7		-10	
Vertical Curve: Crest or Sag, Curve Limits						
Area and Development:	Rural (99999) Mountainous (3)					
Terrain: 1-Flat, 2-Rolling, 3-Mountainous						
Speed: 1-Design, 2-Posted	25 MPH (2)					
Intersection Control Devices: Type, Location and Cycle Timing						
Traffic Stations (Current Year)	B74 0030 03082		B74 0030 03588			
HPMS Sections - AADT 2011	2,200		1,945			
HPMS Sections - AADT 2010	1,616		1,839			
HPMS Sections - AADT 2009	1,600		1,821			
DOD Sections						
Census Tracts						
Functional Classification	Major Collector (5)					
National Highway System (NHS)	Not on NHS (0)					
Previous Projects: Project No., Date and Limits	A 300-01-66 (R) 1968		340D-01-93M (R) 1994		340A-02-72, 1976	

SCALE: (In Miles) 4" = 1 mile

Date Released	Revised
Aug 2003, D.B.	Aug 04 D.B.
	Mar 05 D.B.
	Nov 06 D.B.
	Mar 09 D.B.
	Dec 09 D.B.
	Feb 11 D.B.
	Feb 12 D.B.
	Feb 13 E.P.J.

ROAD INVENTORY
MAUI RTE 30
KAHEKILI HWY

STATE OF HAWAII
DEPARTMENT OF TRANSPORTATION
HIGHWAYS DIVISION
PREPARED BY THE
HIGHWAYS PLANNING BRANCH
IN COOPERATION WITH THE
U.S. DEPARTMENT OF TRANSPORTATION
FEDERAL HIGHWAY ADMINISTRATION

Total Route Length: 41.60 miles
a. Survey Length: 41.60 miles
b. Proposed Length: 0.00 miles
c. Other Length: * 0.00 miles

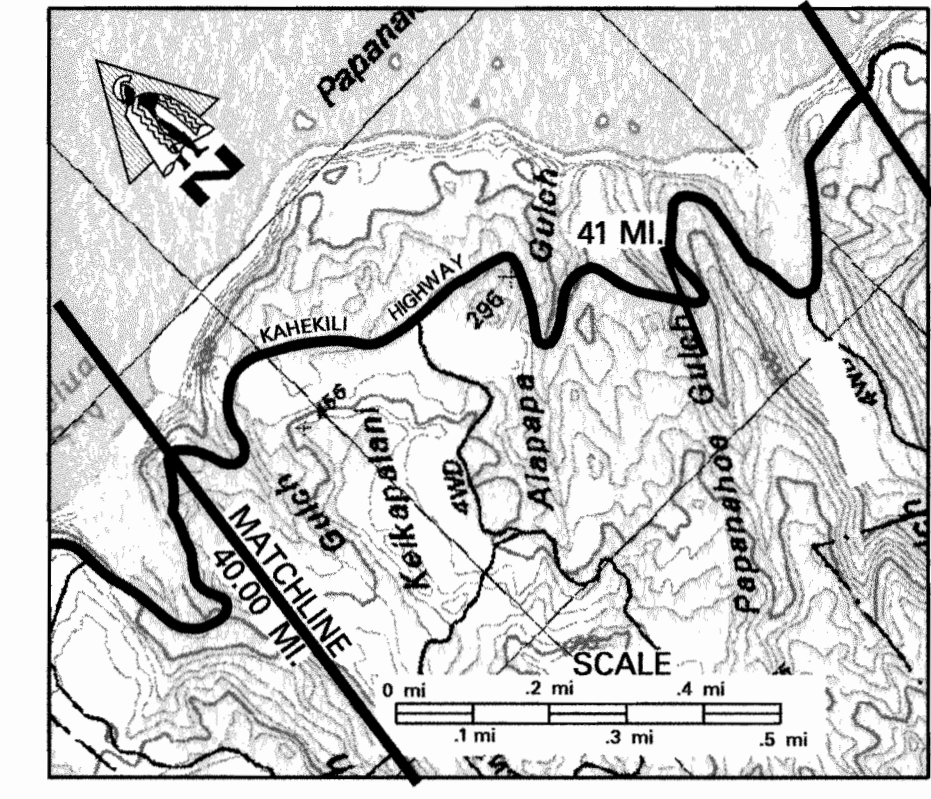

END ROUTE 30
41.60 MI.

SCALE: (In Miles) 4" = 1 mile

Maintenance Control Sections : Length and Description		40	41	42	43	44	45
Structure Carrying Road	Bridges (Over 20'): Length, Type, Capacity and Year Constructed						
	Vertical Clearance						
	Horizontal Clearance						
	Vertical Clearance						
Structure Over Road	Vertical Clearance						
	Horizontal Clearance						
	Vertical Clearance						
	Horizontal Clearance						
Right of Way Width (min.-max.) if varies		40'					
Available Right of Way Width (Needs Study)							
Right of Way Fence: Type - Right and Left							
Control of Access: 1-None, 2-Partial, 3-Full		None					
Jurisdiction, Transfer Phase No. and Date (C to S or S to C)		State					
Project No., Type of Construction, and Year Constructed		30A-01-07M, Repairs and Maintenance, 2008					
Project No., Type of Construction, and Year Constructed		30A-01-95M (Resurface) 1996					

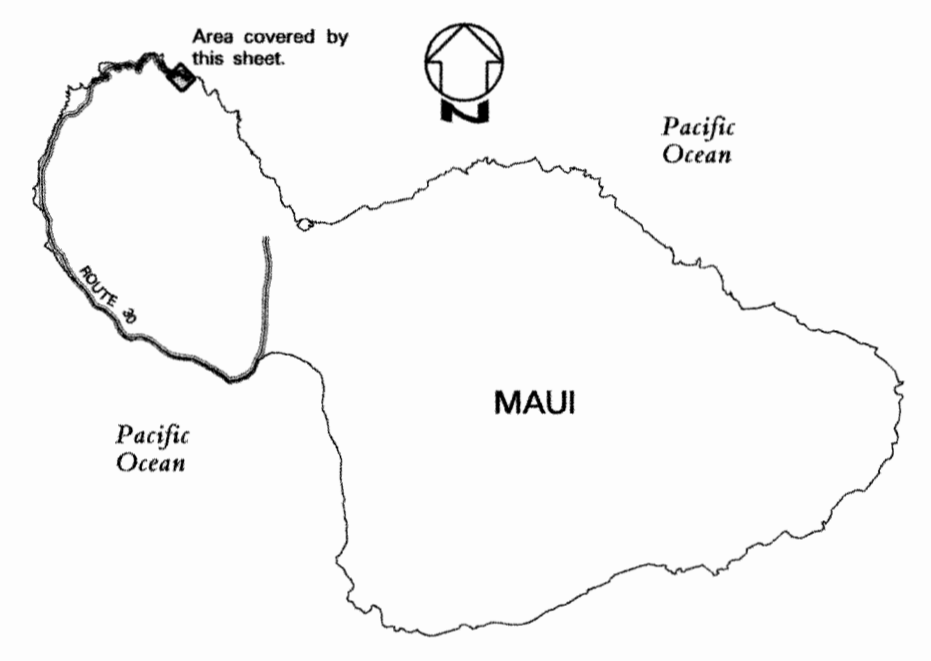

Road Diagram
* MP = Milepost Signage

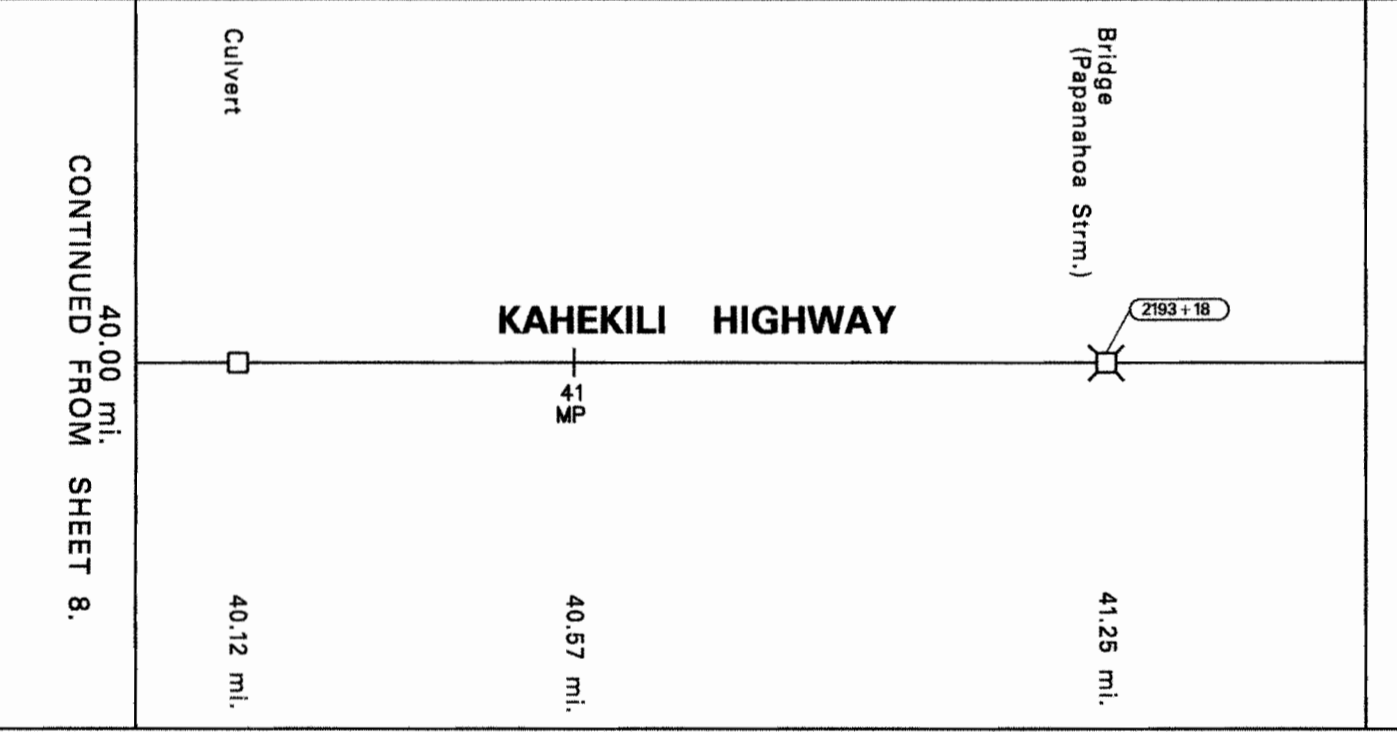

* NOTE: ROUTE LENGTH ADJUSTED TO MATCH 1/2 VIDEOLOG & 1/2 FEATURES DATABASE.
END RTE 30 ON KAHEKILI HIGHWAY 0.35 MI. EAST OF PAPANAHOA STR. BRIDGE @ END OF STATE HWY SIGNS.
* 41.60 MI.

SCALE: (In Miles) 4" = 1 mile

Divided Highway	Shoulder: Width and Type		2' AC					
	Pavement: Width and Type		20' AC					
	Shoulder: Width and Type		2' AC					
	Median: Width and Type							
	Median Barriers:							
	Shoulder: Width and Type							
	Pavement: Width and Type							
	Shoulder: Width and Type							
	Number of Traffic Lanes		2-10'					
	Auxiliary Lanes and Parking Lanes: No. of Lanes and Width (Left Side)							
(Right Side)								
Frontage Road: No. of Lanes, and Width (Right and Left)								
Sidewalk: Width and Type (Right and Left)								
Curb and/or Gutter: Type (Right and Left)								
Protective Devices: Type, Location and Number								
Illumination: Type, Location and Number								
Curves: Degree of Curvature (Right and Left)								
Superelevation (Range)								
Grades: % Grade, Positive or Negative								
Vertical Curve: Crest or Sag, Curve Limits								
Area and Development:								
Terrain: 1-Flat, 2-Rolling, 3-Mountainous								
Speed: 1-Design, 2-Posted								
Intersection Control Devices: Type, Location and Cycle Timing								
Traffic Stations (Current Year)								
HPMS Sections - AADT 2011								
HPMS Sections - AADT 2010								
HPMS Sections - AADT 2009								
DOD Sections								
Census Tracts								
Functional Classification								
National Highway System (NHS)								
Previous Projects: Project No., Date and Limits								

SCALE: (In Miles) 4" = 1 mile

Date Released	Revised
Aug 04 D.B.	
Mar 05 D.B.	
Nov 06 D.B.	
Mar 09 D.B.	
Dec 09 D.B.	
Feb 11 D.B.	
Feb 12 D.B.	
Sept 12 E.P.J.	

ROAD INVENTORY MAUI RTE 31 PIILANI HIGHWAY

STATE OF HAWAII
DEPARTMENT OF TRANSPORTATION
HIGHWAYS DIVISION
PREPARED BY THE
HIGHWAYS PLANNING BRANCH
IN COOPERATION WITH THE
U.S. DEPARTMENT OF TRANSPORTATION
FEDERAL HIGHWAY ADMINISTRATION

Total Route Length: 12.01 miles
a. Survey Length: 7.15 miles
b. Proposed Length: 4.86 miles
c. Other Length: * 0.00 miles

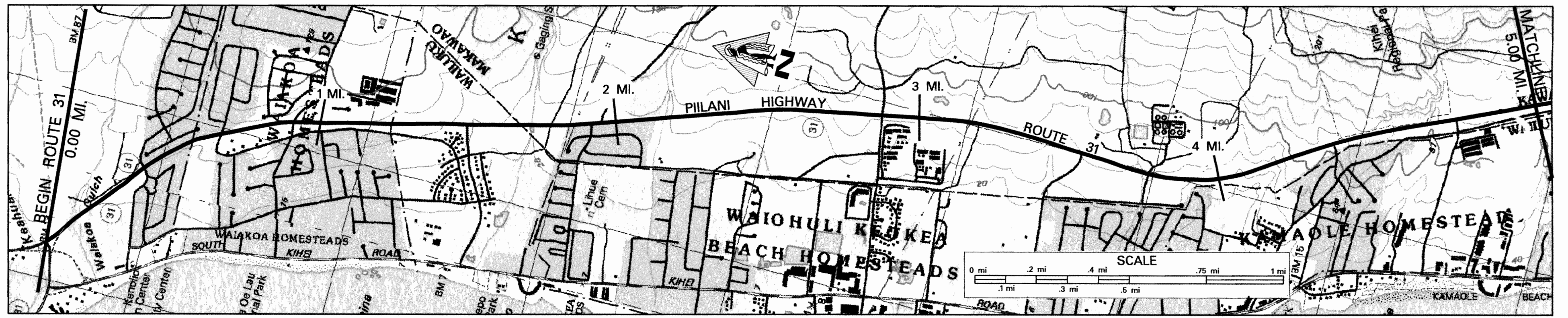

SCALE: (In Miles) 4" = 1 mile

Maintenance Control Sections : Length and Description

Structure Carrying Road	Bridges (Over 20'): Length, Type, Capacity and Year Constructed	
		PRESTRESSED I-BEAM 1981
Vertical Clearance	N.B. 162'-8"	N.B. 167'-6"
	S.B. 150'	S.B. 148'
Horizontal Clearance	270' - 320'	105' - 225'
	WIRE FENCE	CHAINLINK
Right of Way Width (min.-max.) if varies	NONE	
	STATE	
Available Right of Way Width (Needs Study)	NONE	
	STATE	
Right of Way Fence: Type - Right and Left	NONE	
	STATE	
Control of Access: 1-None, 2-Partial, 3-Full	NONE	
	STATE	
Jurisdiction, Transfer Phase No. and Date (C to S or S to C)	NONE	
	STATE	
Project No., Type of Construction, and Year Constructed	31A-01-07M, RESURFACE, 2009	
	ARR-031-1(11), PREVENTIVE MAINTENANCE, 2010	
Project No., Type of Construction, and Year Constructed	STP-0900(58), GUARDRAIL & SHOULDER IMPR., 2004	
	(31AB-01-02) WIDENING, 2003	

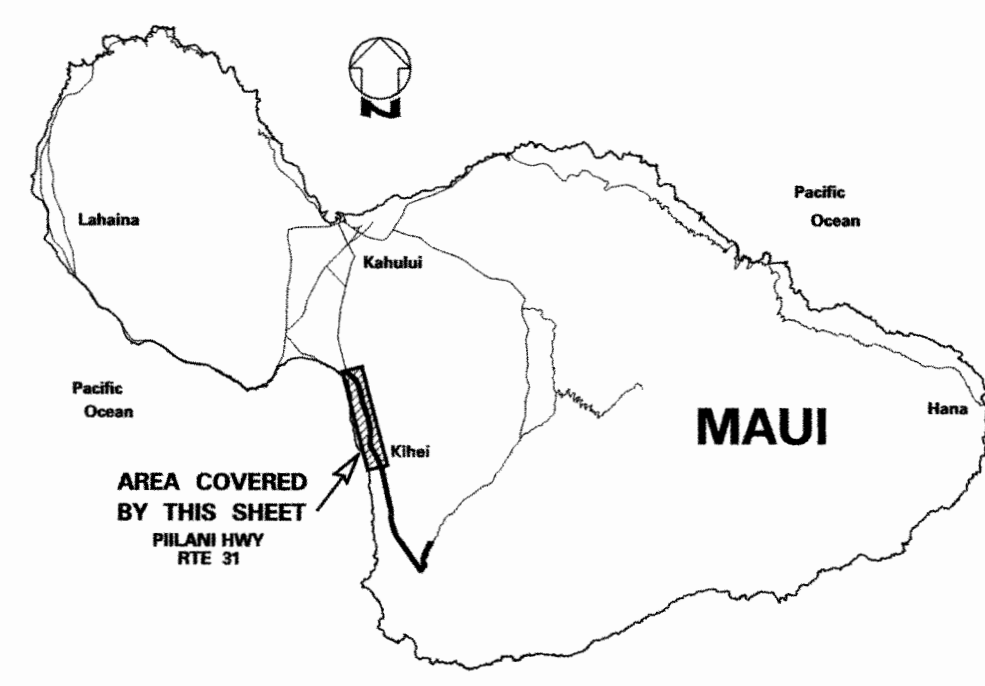

Road Diagram
 * MP = Milepost Signage
 Indicates Grass & / or Physical Barrier on Median.
 BEGIN ROUTE 31 ON PIILANI HIGHWAY AT THE CENTERLINE INTERSECTION WITH NORTH KHEI RD. (RTE 310), (SAME AS END RTE 311 MOULUULE HWY)

Station	0.00	0.14	0.28	0.42	0.56	0.70	0.84	0.98	1.12	1.26	1.40	1.54	1.68	1.82	1.96	2.10	2.24	2.38	2.52	2.66	2.80	2.94	3.08	3.22	3.36	3.50	3.64	3.78	3.92	4.06	4.20	4.34	4.48	4.62	4.76	4.90	5.00
Structure Carrying Road	None																																				
Vertical Clearance	None																																				
Horizontal Clearance	None																																				
Right of Way Width	None																																				
Available Right of Way Width	None																																				
Right of Way Fence	None																																				
Control of Access	None																																				
Jurisdiction	None																																				
Project No., Type of Construction, and Year Constructed	None																																				

CONTINUE ON SHEET #2.
5.00 mi.

SCALE: (In Miles) 4" = 1 mile

Divided Highway	Shoulder: Width and Type (COMBINATION SHOULDER AND BIKE ROUTE FROM 0.00 - 5.93 MILE)	
		8' AC
Shoulder: Width and Type (COMBINATION SHOULDER AND BIKE ROUTE FROM 0.00 - 5.93 MILE)	24' AC	22' AC
	4' AC	0'
Median: Width and Type	10' - 70' FLUSH GRASS	0' - 11' PAINT
	4' AC	0'
Shoulder: Width and Type	24' AC	22' AC
	8' AC	6' - 8' AC
Pavement: Width and Type	24' AC	22' AC
	8' AC	6' - 8' AC
Shoulder: Width and Type (COMBINATION SHOULDER AND BIKE ROUTE FROM 0.00 - 5.93 MILE)	8' AC	6' - 8' AC
	8' AC	6' - 8' AC
Number of Traffic Lanes	4-12'	4-11'
	4-12'	4-11'
Auxiliary Lanes and Parking Lanes: No. of Lanes and Width (Left Side)	0	0
	0	0
Auxiliary Lanes and Parking Lanes: No. of Lanes and Width (Right Side)	0	0
	0	0
Frontage Road: No. of Lanes, and Width (Right and Left)	0	0
	0	0
Sidewalk: Width and Type (Right and Left)	0	0
	0	0
Curb and/or Gutter: Type (Right and Left)	CONCRETE GUTTER	CONCRETE GUTTER
	CONCRETE GUTTER	CONCRETE GUTTER
Protective Devices: Type, Location and Number	ALL GUARDRAILS METAL ON METAL	ALL GUARDRAILS METAL ON METAL
	ALL GUARDRAILS METAL ON METAL	ALL GUARDRAILS METAL ON METAL
Illumination: Type, Location and Number	0	0
	0	0
Curves: Degree of Curvature (Right and Left)	0.00	0.00
	0.00	0.00
Superelevation (Range)	0.00	0.00
	0.00	0.00
Grades: % Grade, Positive or Negative	0.00	0.00
	0.00	0.00
Vertical Curve: Crest or Sag, Curve Limits	0	0
	0	0
Area and Development:	0	0
	0	0
Terrain: 1-Flat, 2-Rolling, 3-Mountainous	FLAT (1)	FLAT (1)
	FLAT (1)	FLAT (1)
Speed: 1-Design, 2-Posted	30 MPH (2)	40 MPH (2)
	30 MPH (2)	40 MPH (2)
Intersection Control Devices: Type, Location and Cycle Timing	4 PHASE	3 PHASE
	4 PHASE	3 PHASE
Traffic Stations (Current Year)	B74 0031 00000	B47 0031 00281
	B74 0031 00000	B47 0031 00281
HPMS Sections - AADT 2011	34,400	24,712
	34,400	24,712
HPMS Sections - AADT 2010	32,724	23,370
	32,724	23,370
HPMS Sections - AADT 2009	32,400	23,139
	32,400	23,139
DOD Sections	0	0
	0	0
Census Tracts	0	0
	0	0
Functional Classification	PRINCIPAL ARTERIAL (3)	PRINCIPAL ARTERIAL (3)
	ON NHS (1)	ON NHS (1)
National Highway System (NHS)	0	0
	0	0
Previous Projects: Project No., Date and Limits	0.00 STP-0900(58), GUARDRAIL & SHOULDER IMPR., 2004	0.00 STP-0900(58), GUARDRAIL & SHOULDER IMPR., 2004
	0.00 STP-0900(58), GUARDRAIL & SHOULDER IMPR., 2004	0.00 STP-0900(58), GUARDRAIL & SHOULDER IMPR., 2004

SCALE: (In Miles) 4" = 1 mile

Date Released	Revised
Oct 2004 CN	
Nov. 06 D.B.	
Mar. 08 D.B.	
Jan. 09 D.B.	
Dec. 09 D.B.	
Feb. 11 D.B.	
Feb. 12 D.B.	
Feb. 13 E.P.	

ROAD INVENTORY MAUI RTE 31 PIILANI HIGHWAY

STATE OF HAWAII
DEPARTMENT OF TRANSPORTATION
HIGHWAYS DIVISION
PREPARED BY THE
HIGHWAYS PLANNING BRANCH
IN COOPERATION WITH THE
U.S. DEPARTMENT OF TRANSPORTATION
FEDERAL HIGHWAY ADMINISTRATION

Total Route Length: 12.01 miles
 a. Survey Length: 7.15 miles
 b. Proposed Length: 4.86 miles
 c. Other Length: * 0.00 miles

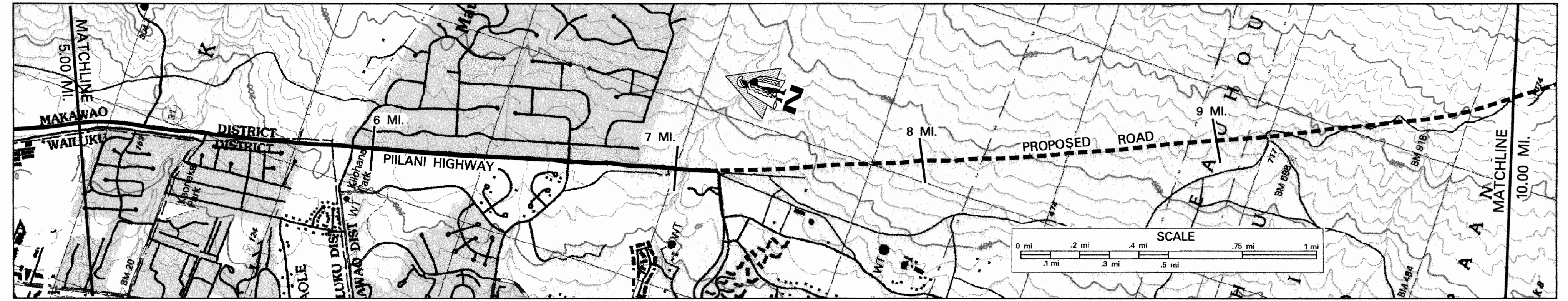

SCALE: (In Miles) 4" = 1 mile

Maintenance Control Sections : Length and Description

Structure Carrying Road	Bridges (Over 20'): Length, Type, Capacity and Year Constructed
	Vertical Clearance
	Horizontal Clearance
	Vertical Clearance
Structure Over Road	Horizontal Clearance
	Vertical Clearance
	Horizontal Clearance
	Vertical Clearance

Right of Way Width (min.-max.) if varies

Available Right of Way Width (Needs Study)

Right of Way Fence: Type - Right and Left

Control of Access: 1-None, 2-Partial, 3-Full

Jurisdiction, Transfer Phase No. and Date (C to S or S to C)

Project No., Type of Construction, and Year Constructed

Project No., Type of Construction, and Year Constructed

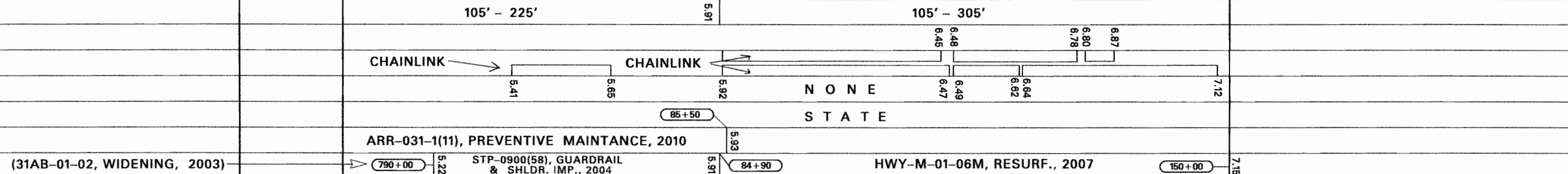

ARR-031-1(11), PREVENTIVE MAINTANCE, 2010
 STP-0900(58), GUARDRAIL & SHLDR. IMP., 2004
 HWY-M-01-06M, RESURF., 2007

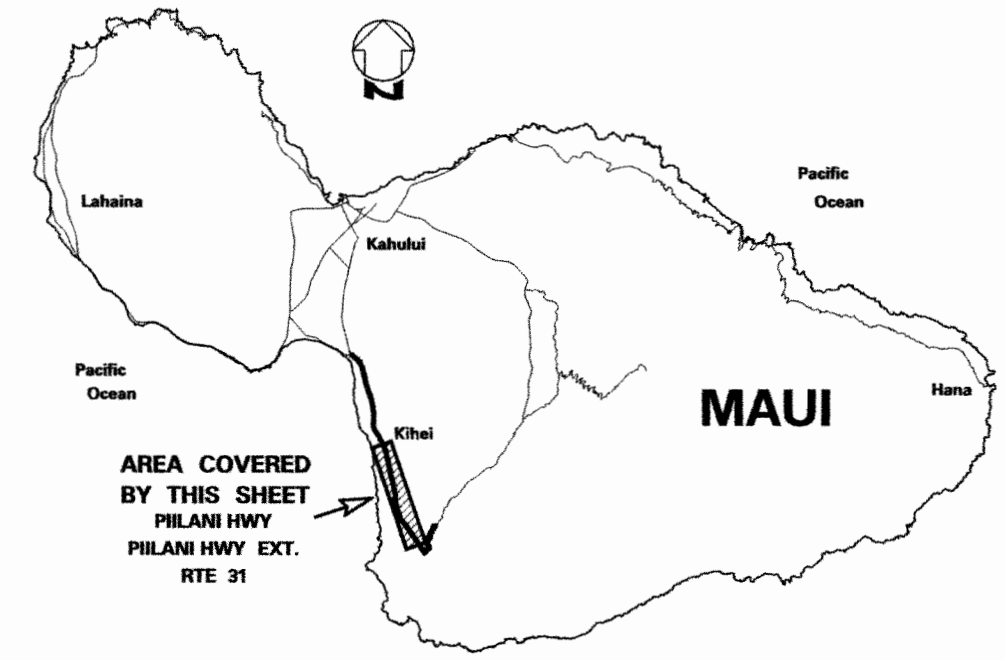

Indicates Grass & / or Physical Barrier on Median.

Road Diagram

* MP=Milepost Signage

Continued from Sheet # 1

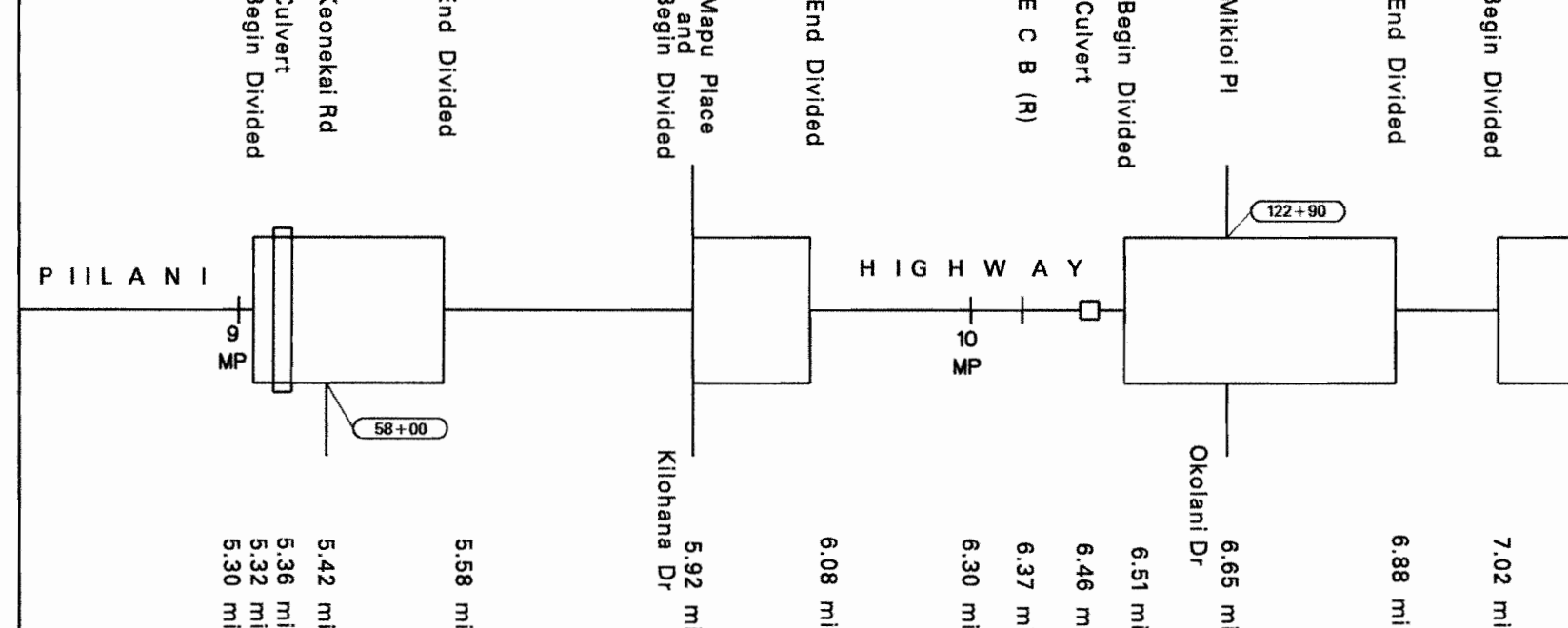

* NOTE: ROUTE LENGTH ADJUSTED TO MATCH VISUALS & THE FEATURES DATABASE. Begin proposed on Piilani Highway at the centerline of Wailea Iki Drive +7.15 mi.

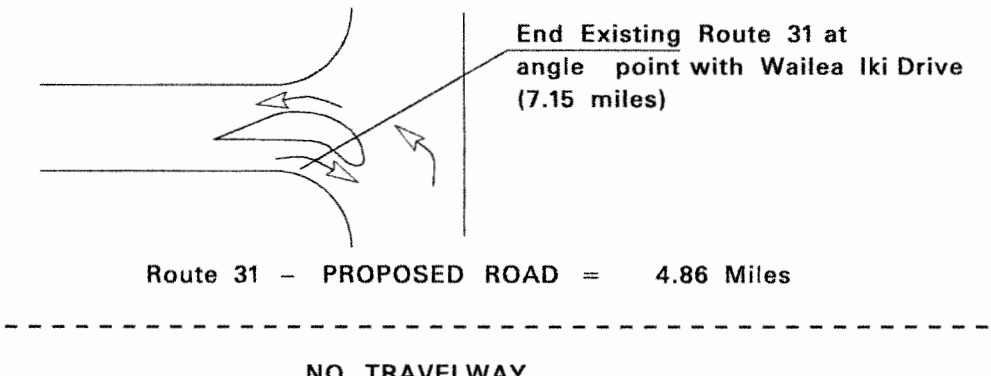

Continued on sheet # 3

SCALE: (In Miles) 4" = 1 mile

Divided Highway	Shoulder: Width and Type
	Pavement: Width and Type
	Median: Width and Type
	Median Barriers:
Undivided	Shoulder: Width and Type
	Pavement: Width and Type
	Shoulder: Width and Type

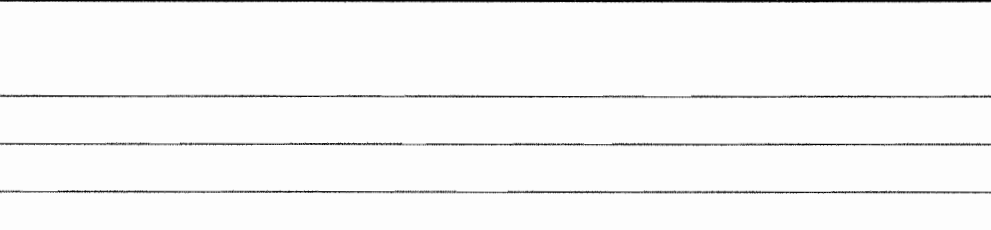
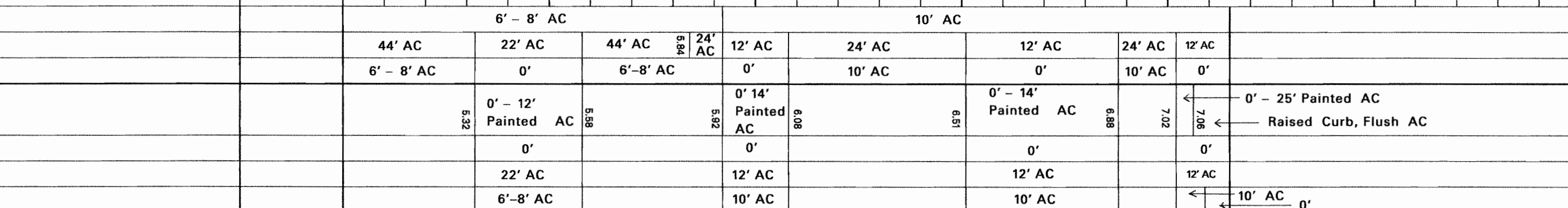

Number of Traffic Lanes

Auxiliary Lanes and Parking Lanes: No. of Lanes and Width (Left Side)

(Right Side)

Frontage Road: No. of Lanes, and Width (Right and Left)

Sidewalk: Width and Type (Right and Left)

Curb and/or Gutter: Type (Right and Left)

Protective Devices: Type, Location and Number

Illumination: Type, Location and Number

Curves: Degree of Curvature (Right and Left)

Superelevation (Range)

Grades: % Grade, Positive or Negative

Vertical Curve: Crest or Sag, Curve Limits

Area and Development:

Terrain: 1-Flat, 2-Rolling, 3-Mountainous

Speed: 1-Design, 2-Posted

Intersection Control Devices: Type, Location and Cycle Timing

Traffic Stations (Current Year)

HPMS Sections - AADT 2011

HPMS Sections - AADT 2010

HPMS Sections - AADT 2009

DOD Sections

Census Tracts

Functional Classification

National Highway System (NHS)

Previous Projects: Project No., Date and Limits

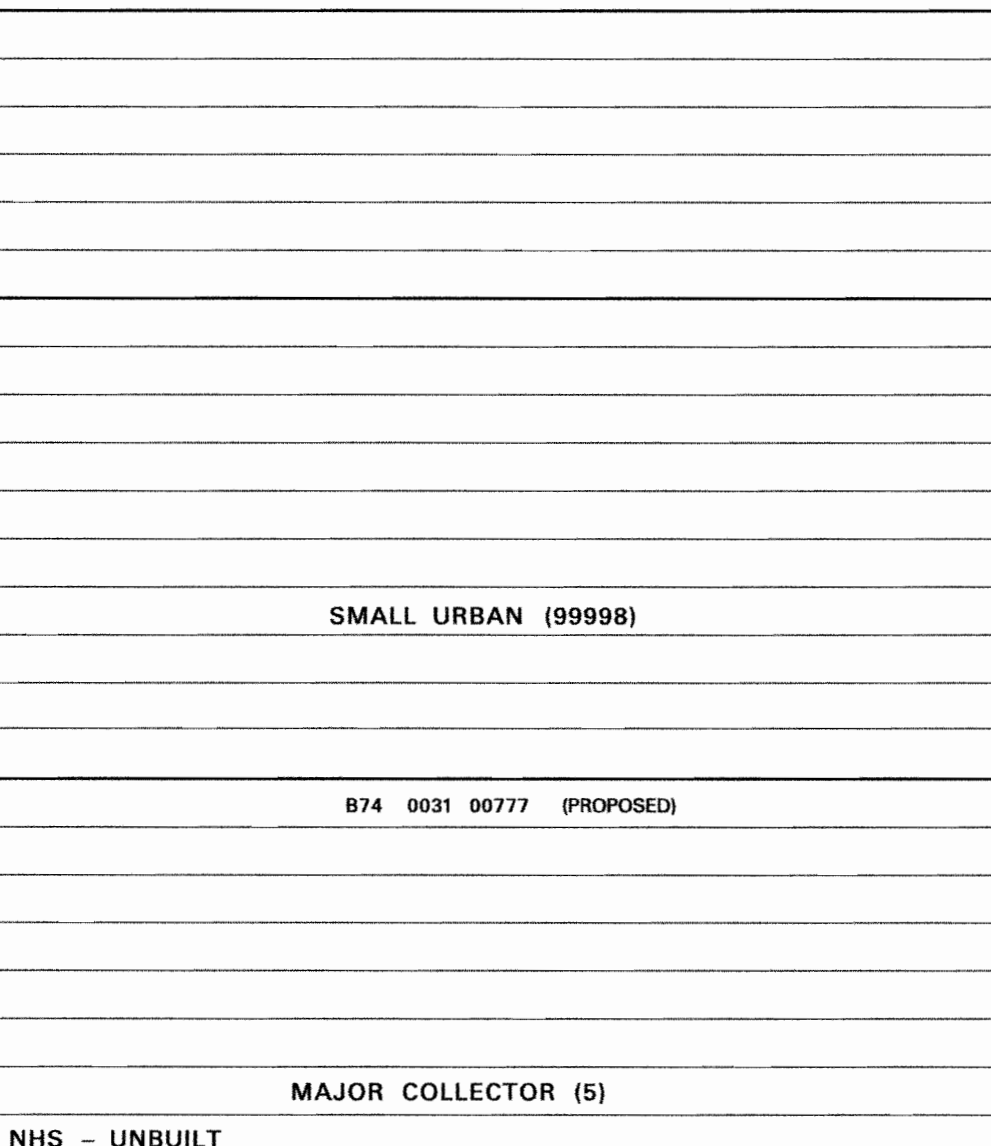
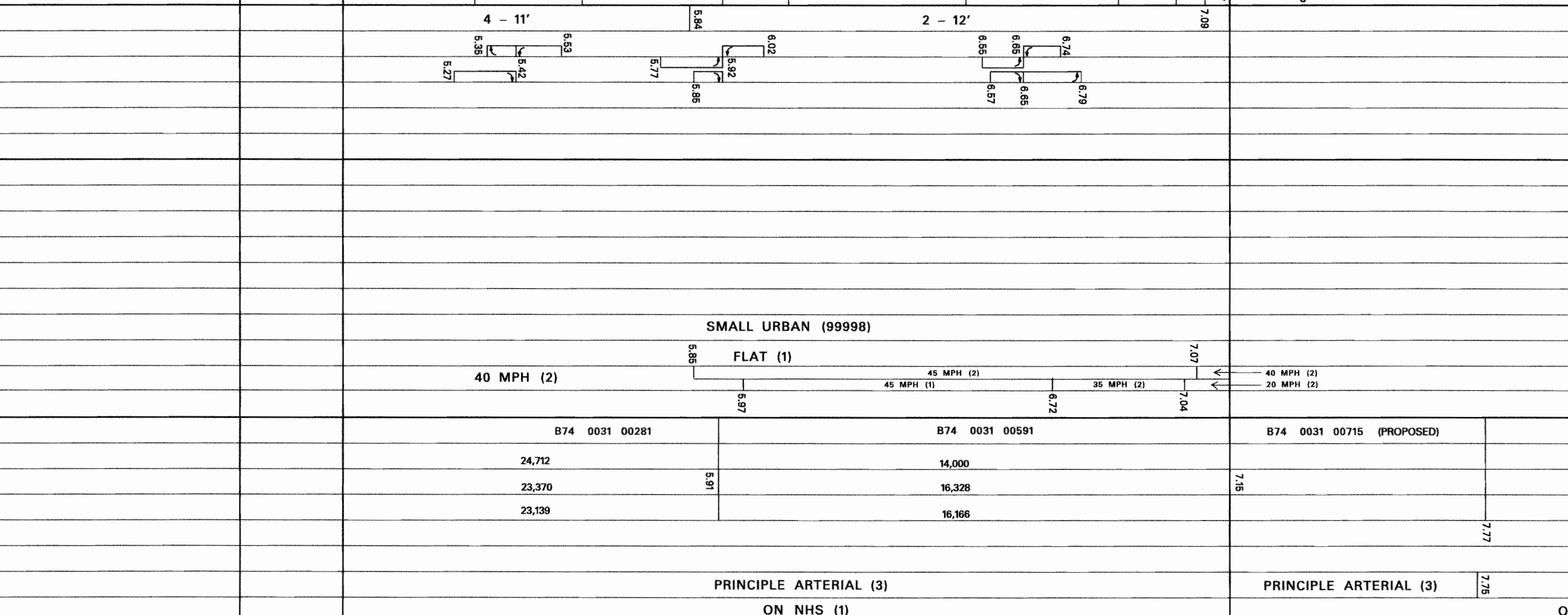

SCALE: (In Miles) 4" = 1 mile

5.22-0900 STP-0900(58), GUARDRAIL & SHLDR. IMP., 2004
 31AB-01-02, WIDENING, 2003
 STP-031-1(8), RESURFACING 1996
 TQF-RF-031-1(6) 1981

6 F-031-1(3) 1990

Date Released	Oct 2004 GN
Revised	
Nov. 06	D.B.
Feb. 08	D.B.
Jan. 09	D.B.
Dec. 09	D.B.
Feb. 11	D.B.
Feb. 12	D.B.
Feb. 13	E.P.F.

ROAD INVENTORY MAUI RTE 31 PIILANI HIGHWAY

STATE OF HAWAII
DEPARTMENT OF TRANSPORTATION
HIGHWAYS DIVISION

PREPARED BY THE
HIGHWAYS PLANNING BRANCH
IN COOPERATION WITH THE
U.S. DEPARTMENT OF TRANSPORTATION
FEDERAL HIGHWAY ADMINISTRATION

Total Route Length: 12.01 miles
 a. Survey Length: 7.15 miles
 b. Proposed Length: 4.86 miles
 c. Other Length: * 0.00 miles

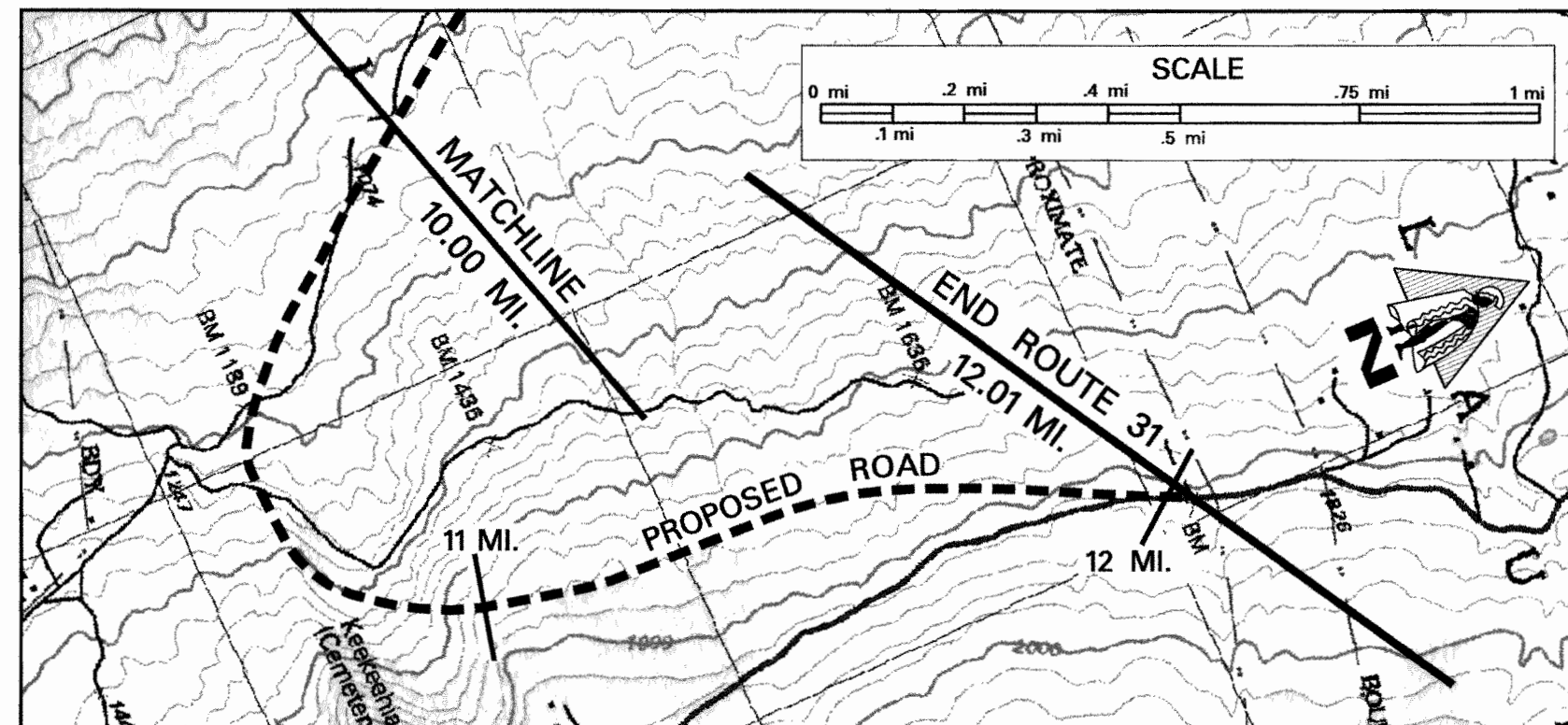

SCALE: (In Miles) 4" = 1 mile

Maintenance Control Sections : Length and Description

Structure Carrying Road
 Bridges (Over 20'): Length, Type, Capacity and Year Constructed
 Vertical Clearance
 Horizontal Clearance
 Structure Not Road
 Vertical Clearance
 Horizontal Clearance

Right of Way Width (min.-max.) if varies
 Available Right of Way Width (Needs Study)
 Right of Way Fence: Type - Right and Left
 Control of Access: 1-None, 2-Partial, 3-Full
 Jurisdiction, Transfer Phase No. and Date (C to S or S to C)
 Project No., Type of Construction, and Year Constructed
 Project No., Type of Construction, and Year Constructed

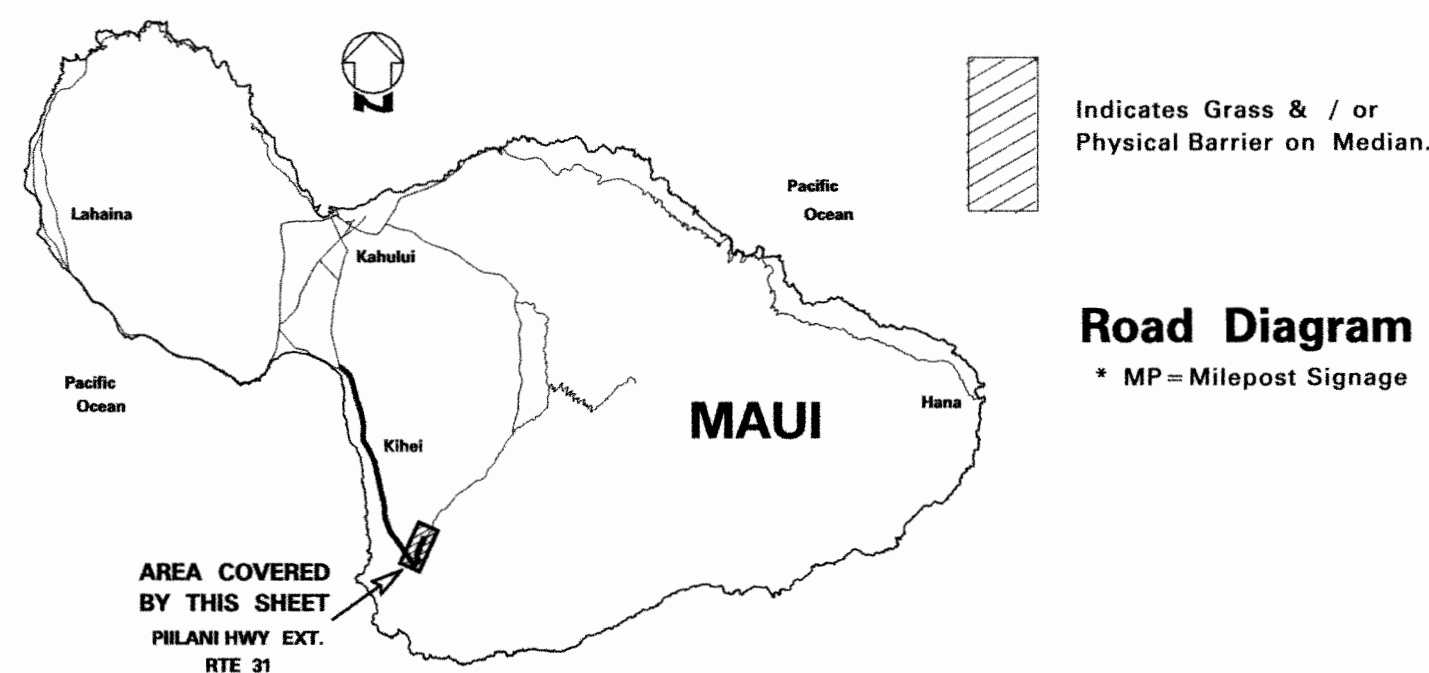

Continued from sheet # 2

Route 31 - PROPOSED ROAD = 4.86 Mile
 NO TRAVELWAY

End Route 31 on Proposed Road at the
 Southwest edge of pavement of Kula
 Highway and Makana Road
 12.01 mi.

END ROUTE DESCRIPTION
 0.00 mi.

SCALE: (In Miles) 4" = 1 mile

Divided Highway
 Undivided
 Shoulder: Width and Type
 Pavement: Width and Type
 Shoulder: Width and Type
 Median: Width and Type
 Median Barriers:
 Shoulder: Width and Type
 Pavement: Width and Type
 Shoulder: Width and Type

Number of Traffic Lanes
 Auxiliary Lanes and Parking Lanes: No. of Lanes and Width (Left Side)
 (Right Side)
 Frontage Road: No. of Lanes, and Width (Right and Left)
 Sidewalk: Width and Type (Right and Left)
 Curb and/or Gutter: Type (Right and Left)
 Protective Devices: Type, Location and Number
 Illumination: Type, Location and Number
 Curves: Degree of Curvature (Right and Left)
 Superelevation (Range)
 Grades: % Grade, Positive or Negative
 Vertical Curve: Crest or Sag, Curve Limits
 Area and Development:

SMALL URBAN (99998)

Terrain: 1-Flat, 2-Rolling, 3-Mountainous
 Speed: 1-Design, 2-Posted
 Intersection Control Devices: Type, Location and Cycle Timing
 Traffic Stations (Current Year)
 HPMS Sections - AADT 2011
 HPMS Sections - AADT 2010
 HPMS Sections - AADT 2009
 DOD Sections
 Census Tracts
 Functional Classification
 National Highway System (NHS)
 Previous Projects: Project No., Date and Limits

874 0031 00777 (PROPOSED)

MAJOR COLLECTOR (5)
 ON NHS - UNBUILT

SCALE: (In Miles) 4" = 1 mile

Date Released	
Oct 2004	GN
Revised	
Nov. 06	D.B.
Feb. 11	D.B.
Feb. 12	D.B.
Sept. 12	E.P.J.

ROAD INVENTORY MAUI RTE 32 MAIN ST. - KAAHUMANU AVE.

STATE OF HAWAII
DEPARTMENT OF TRANSPORTATION
HIGHWAYS DIVISION

PREPARED BY THE
HIGHWAYS PLANNING BRANCH
IN COOPERATION WITH THE
U.S. DEPARTMENT OF TRANSPORTATION
FEDERAL HIGHWAY ADMINISTRATION

Total Designated Route Length:	2.85	MILES (a + b)
a. Existing Length:	2.85	MILES
b. Proposed Length:	0.00	MILES
Total Travel Way Length:	2.85	MILES (a + b, less c)
a. Existing Length:	2.85	MILES
b. Temporary Length:	0.00	MILES
c. Length used as T.W. for another Route:	0.00	MILES (-)

NEEDS STUDY ROUTE NO. _____ FUNCTIONAL CLASSIFICATION _____

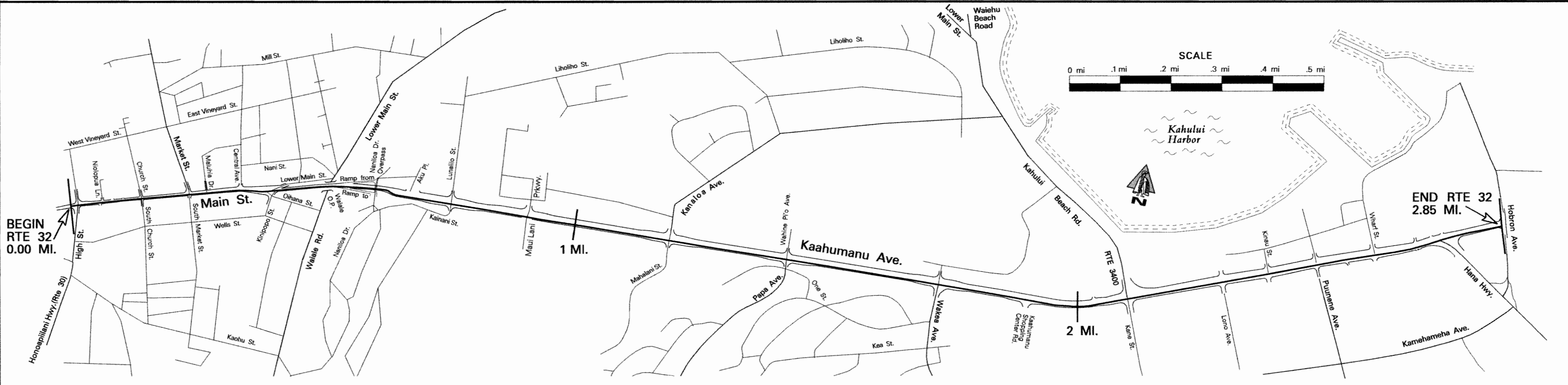

Maintenance Control Sections : Length and Description	0	1	2	3
Begin 32 A at the E of High St.	32 A (2.84 Mi.)			End 32 A at Kaaumanu Ave. at the E Intersection with Hobron St.

Structure Carrying Road	Bridges (Over 20'): Length, Type, Capacity and Year Constructed	Steel Multistringer 1936 H15 79' 0.51	Conc. Frame 1936 H15 0.60
	Vertical Clearance	34' 1	14' 10"
Structure Over Road	Horizontal Clearance	50'	115' - 265'
	Vertical Clearance	45'	125' - 160'
Right of Way Width (min.-max.) if varies		Urban / Commercial	Bushes with Slight Cut Slope
Available Right of Way Width (Needs Study)		(Chain Link 50' from Edge of Pavement)	Urban / Commercial
Right of Way Fence: Type - Right and Left			
Control of Access: 1-None, 2-Partial, 3-Full			
Jurisdiction, Transfer Phase No. and Date (C to S or S to C)			Partial State
Project No., Type of Construction, and Year Constructed		STP-NH-0900(62), RESURF., 2004 0.34	NH-032-1(8), Resurface, 2002
Project No., Type of Construction, and Year Constructed			NH-STP-032-1(6), Traffic Signals & Widening, 2002

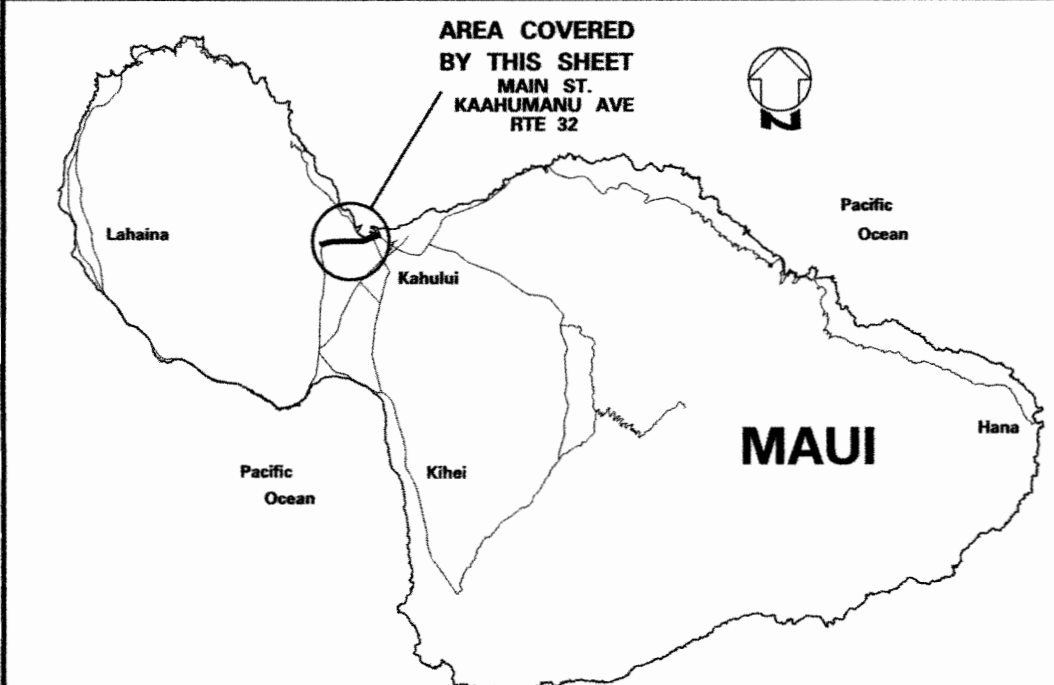

Road Diagram
* MP = Milepost Signage

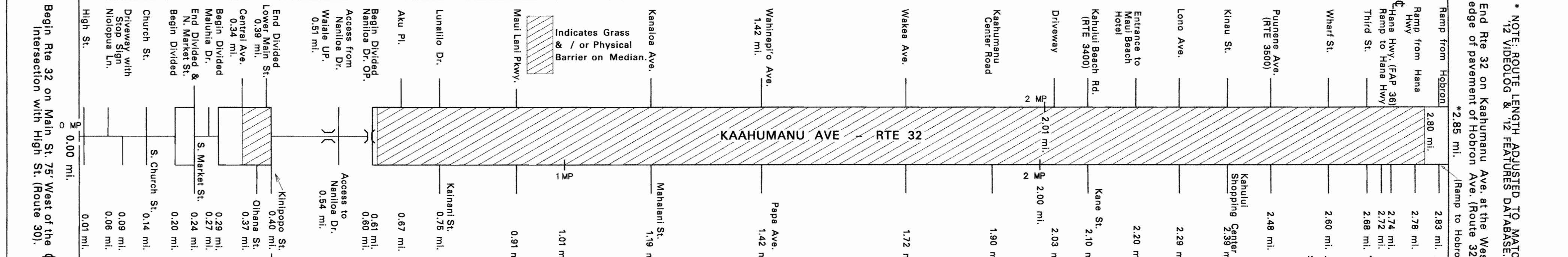

Divided Highway	Shoulder: Width and Type	0	1	2	3
	Pavement: Width and Type	26' AC	23' AC	12' AC	24' AC
Undivided	Shoulder: Width and Type	0	0	0	0
	Median: Width and Type	0	0	0	0
Divided Highway	Shoulder: Width and Type	0	0	0	0
	Pavement: Width and Type	0	0	0	0
Divided Highway	Shoulder: Width and Type	0	0	0	0
	Pavement: Width and Type	0	0	0	0
Number of Traffic Lanes		1-11'	1-12'	1-14'	2-12'
Auxiliary Lanes and Parking Lanes: No. of Lanes and Width (Left Side)		PL - 8' Parking Lane	PL - 8' Parking Lane	PL - 8' Parking Lane	PL - 8' Parking Lane
Frontage Road: No. of Lanes, and Width (Right and Left)					
Sidewalk: Width and Type (Right and Left)					
Curb and/or Gutter: Type (Right and Left)		1-AC Curb	1-AC Curb	1-AC Curb	1-AC Curb
Protective Devices: Type, Location and Number					
Illumination: Type, Location and Number					
Curves: Degree of Curvature (Right and Left)					
Superelevation (Range)					
Grades: % Grade, Positive or Negative		0.08	-4	0.02	0.08
Vertical Curve: Crest or Sag, Curve Limits					
Area and Development:					
Terrain: 1-Flat, 2-Rolling, 3-Mountainous					
Speed: 1-Design, 2-Posted		20 MPH (2)	45 MPH (2)	30 MPH (2)	
Intersection Control Devices: Type, Location and Cycle Timing		Ph. = Phase	Ph. = Phase	Ph. = Phase	Ph. = Phase
Traffic Stations (Current Year)		874 0032 00000	874 0032 00024	874 0032 00040	874 0032 00061
HPMS Sections - AADT 2011		11,500	12,816	23,600	22,600
HPMS Sections - AADT 2010		10,908	12,120	23,432	25,619
HPMS Sections - AADT 2009		10,800	12,000	23,200	25,365
DOD Sections			0.24	0.40	
Census Tracts					
Functional Classification		Principal Art. (Conn. Link) (3)			Principal Arterial (3)
National Highway System (NHS)					On NHS (1)
Previous Projects: Project No., Date and Limits					

Scale: 1" = 0.15 mile

ROAD INVENTORY MAUI RTE 32A HOBRON AVENUE

STATE OF HAWAII
DEPARTMENT OF TRANSPORTATION
HIGHWAYS DIVISION
PREPARED BY THE
HIGHWAYS PLANNING BRANCH
IN COOPERATION WITH THE
U.S. DEPARTMENT OF TRANSPORTATION
FEDERAL HIGHWAY ADMINISTRATION

Total Route Length: 0.39 miles
a. Survey Length: 0.39 miles
b. Proposed Length: 0.00 miles
c. Other Length: * 0.00 miles

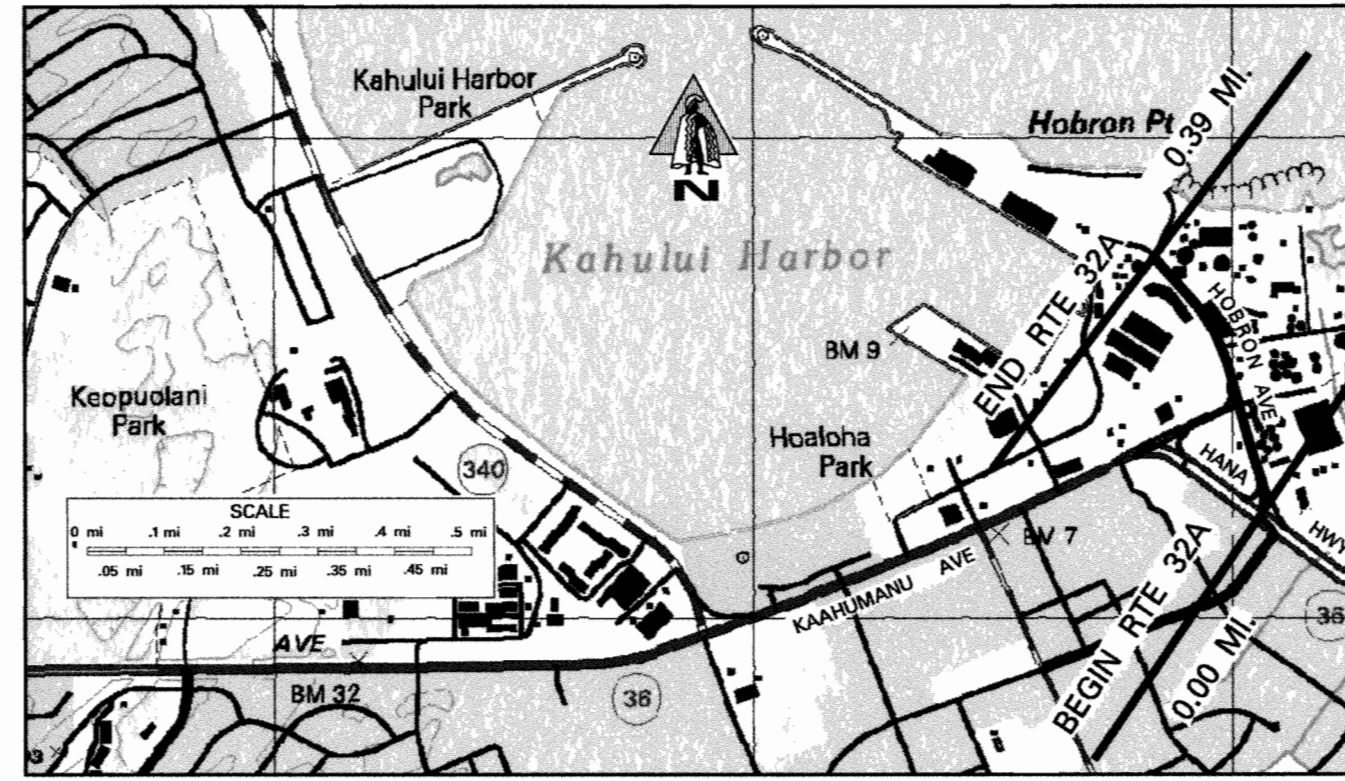

SCALE: (In Miles) 20" = 1 mile

Maintenance Control Sections : Length and Description	<table style="width: 100%; border-collapse: collapse;"> <tr> <td style="width: 33%;">Begin 32A same as begin route.</td> <td style="width: 33%; text-align: center;">32A (0.41 MI)</td> <td style="width: 33%;">End 32A same as end route.</td> </tr> </table>	Begin 32A same as begin route.	32A (0.41 MI)	End 32A same as end route.						
Begin 32A same as begin route.	32A (0.41 MI)	End 32A same as end route.								
Structure Carrying Road	<table style="width: 100%; border-collapse: collapse;"> <tr> <td style="width: 33%;">Bridges (Over 20'): Length, Type, Capacity and Year Constructed</td> <td style="width: 33%;"></td> <td style="width: 33%;"></td> </tr> <tr> <td>Vertical Clearance</td> <td></td> <td></td> </tr> <tr> <td>Horizontal Clearance</td> <td></td> <td></td> </tr> </table>	Bridges (Over 20'): Length, Type, Capacity and Year Constructed			Vertical Clearance			Horizontal Clearance		
Bridges (Over 20'): Length, Type, Capacity and Year Constructed										
Vertical Clearance										
Horizontal Clearance										
Structure Over Road	<table style="width: 100%; border-collapse: collapse;"> <tr> <td style="width: 33%;">Vertical Clearance</td> <td style="width: 33%;"></td> <td style="width: 33%;"></td> </tr> <tr> <td>Horizontal Clearance</td> <td></td> <td></td> </tr> </table>	Vertical Clearance			Horizontal Clearance					
Vertical Clearance										
Horizontal Clearance										
Right of Way Width (min.-max.) if varies	80' 50'									
Available Right of Way Width (Needs Study)	COMMERCIAL DISTRICT									
Right of Way Fence: Type - Right and Left	NONE									
Control of Access: 1-None, 2-Partial, 3-Full	NONE									
Jurisdiction, Transfer Phase No. and Date (C to S or S to C)	STATE STATE PHASE II COUNTY TO STATE									
Project No., Type of Construction, and Year Constructed	HWY-M-01-05 (R) 2006									
Project No., Type of Construction, and Year Constructed	HWY-M-01-91M (R) 1992									

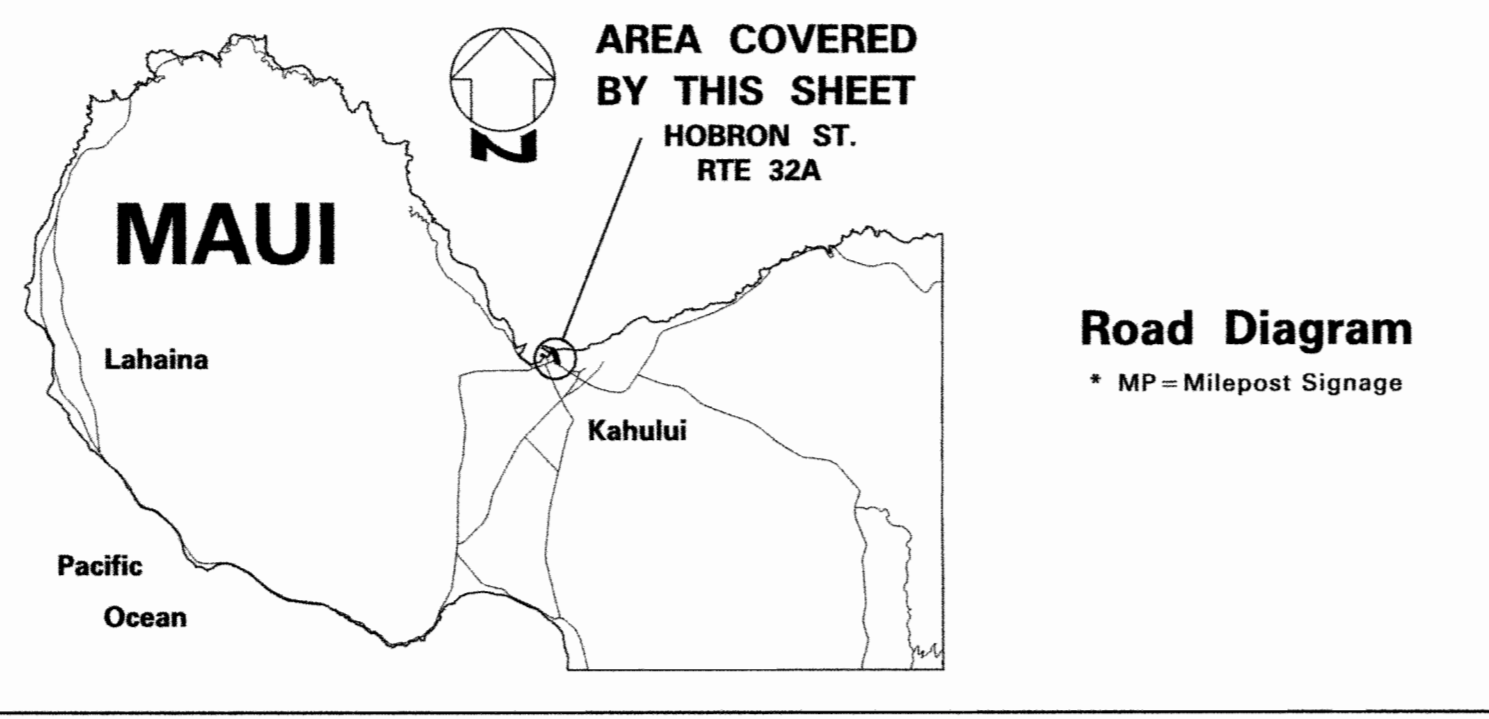

Right of Way Width (min.-max.) if varies	80' 50'
Available Right of Way Width (Needs Study)	COMMERCIAL DISTRICT
Right of Way Fence: Type - Right and Left	NONE
Control of Access: 1-None, 2-Partial, 3-Full	NONE
Jurisdiction, Transfer Phase No. and Date (C to S or S to C)	STATE STATE PHASE II COUNTY TO STATE
Project No., Type of Construction, and Year Constructed	HWY-M-01-05 (R) 2006
Project No., Type of Construction, and Year Constructed	HWY-M-01-91M (R) 1992
Right of Way Width (min.-max.) if varies	80' 50'
Available Right of Way Width (Needs Study)	COMMERCIAL DISTRICT
Right of Way Fence: Type - Right and Left	NONE
Control of Access: 1-None, 2-Partial, 3-Full	NONE
Jurisdiction, Transfer Phase No. and Date (C to S or S to C)	STATE STATE PHASE II COUNTY TO STATE
Project No., Type of Construction, and Year Constructed	HWY-M-01-05 (R) 2006
Project No., Type of Construction, and Year Constructed	HWY-M-01-91M (R) 1992

SCALE: (In Miles) 20" = 1 mile

Shoulder: Width and Type	6' AC
Pavement: Width and Type	22' AC 33' AC 22' AC
Shoulder: Width and Type	6' AC 10'-15' Gravel 6' AC
Median: Width and Type	11' Painted AC
Shoulder: Width and Type	11' AC
Pavement: Width and Type	6' AC
Shoulder: Width and Type	6' AC
Number of Traffic Lanes	2 - 11' 2 - 11'
Auxiliary Lanes and Parking Lanes: No. of Lanes and Width (Left Side)	1 - 11'
(Right Side)	1 - 11'
Frontage Road: No. of Lanes, and Width (Right and Left)	
Sidewalk: Width and Type (Right and Left)	
Curb and/or Gutter: Type (Right and Left)	
Protective Devices: Type, Location and Number	
Illumination: Type, Location and Number	1.0W 1.0W
Curves: Degree of Curvature (Right and Left)	
Superelevation (Range)	
Grades: % Grade, Positive or Negative	
Vertical Curve: Crest or Sag, Curve Limits	
Area and Development:	Small Urban (99998)
Terrain: 1-Flat, 2-Rolling, 3-Mountainous	FLAT (1)
Speed: 1-Design, 2-Posted	20 MPH (2) NOT POSTED
Intersection Control Devices: Type, Location and Cycle Timing	
Traffic Stations (Current Year)	674 032A 00000
HPMS Sections - AADT 2011	4,300
HPMS Sections - AADT 2010	4,141
HPMS Sections - AADT 2009	4,100
DOD Sections	
Census Tracts	
Functional Classification	Principal Arterial (3)
National Highway System (NHS)	On NHS (1)
Previous Projects: Project No., Date and Limits	DANC 8 (1) 1945 COUNTY

SCALE: (In Miles) 20" = 1 mile

Date Released	
Oct. 2004, G.N.	
Revised	
Nov. 06, D.B.	
Dec. 09, D.B.	
Feb. 11, D.B.	
Feb. 12, D.B.	
Feb. 13, E.P.J.	

ROAD INVENTORY MAUI RTE 32B WHARF STREET

STATE OF HAWAII
DEPARTMENT OF TRANSPORTATION
HIGHWAYS DIVISION
PREPARED BY THE
HIGHWAYS PLANNING BRANCH
IN COOPERATION WITH THE
U.S. DEPARTMENT OF TRANSPORTATION
FEDERAL HIGHWAY ADMINISTRATION

Total Route Length: 0.17 miles
 a. Survey Length: 0.17 miles
 b. Proposed Length: 0.00 miles
 c. Other Length: * 0.17 miles

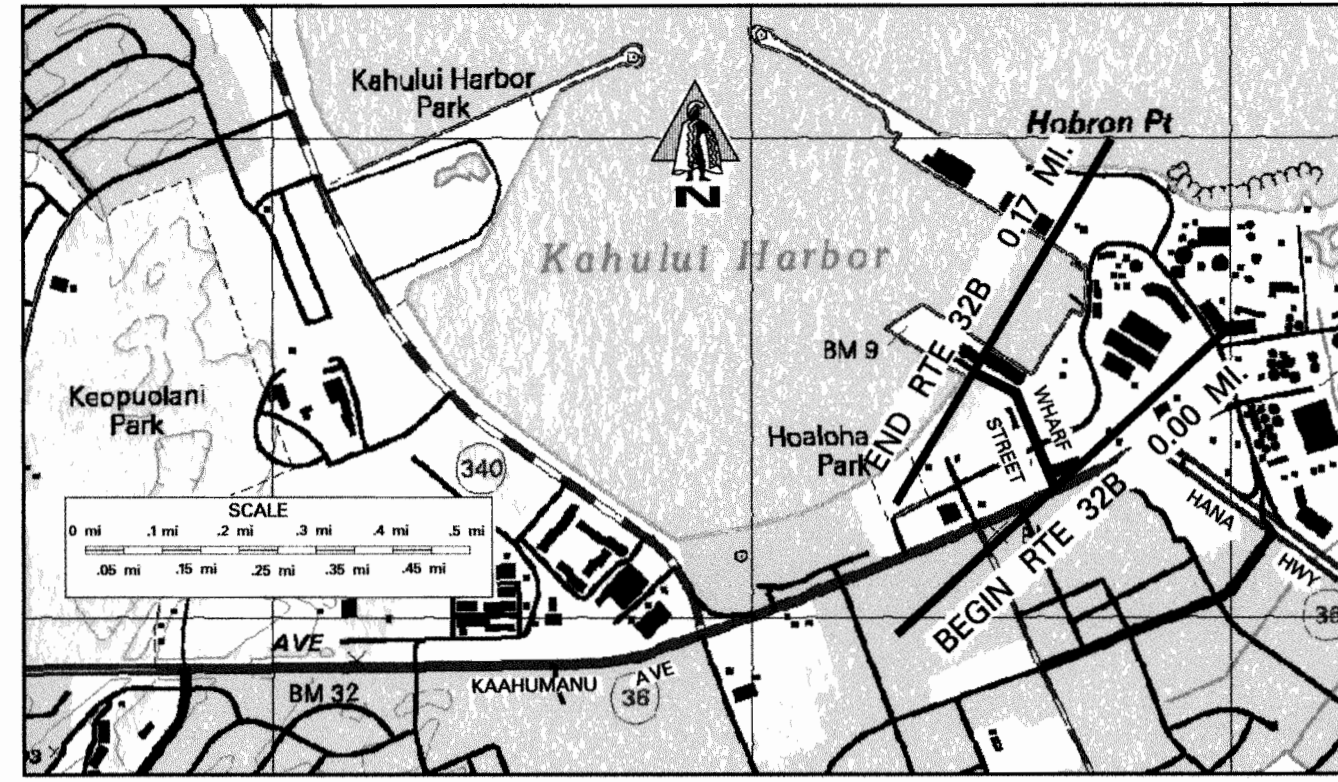

SCALE: (In Miles) 20" = 1 mile

Maintenance Control Sections : Length and Description	0.0	0.10	0.20	0.30	0.40	0.50	0.60	0.70	0.80	0.90	1.00
---	-----	------	------	------	------	------	------	------	------	------	------

Structure Carrying Road	Bridges (Over 20'): Length, Type, Capacity and Year Constructed	32B (0.17 MI)	Begin and end 32B same as begin and end route 32B
	Vertical Clearance		
Structure Over Road	Horizontal Clearance		
	Vertical Clearance		
Right of Way Width (min.-max.) if varies		60'	
Available Right of Way Width (Needs Study)		COMMERCIAL AREA	
Right of Way Fence: Type - Right and Left		Chain Link Fence	
Control of Access: 1-None, 2-Partial, 3-Full		NONE	
Jurisdiction, Transfer Phase No. and Date (C to S or S to C)		STATE	
Project No., Type of Construction, and Year Constructed		HWY-M-01-05M 2006 (R)	LT-M-01-78M (R) WDR 34(1)
Project No., Type of Construction, and Year Constructed		HWY-M-01-91M 1992 (R)	1979

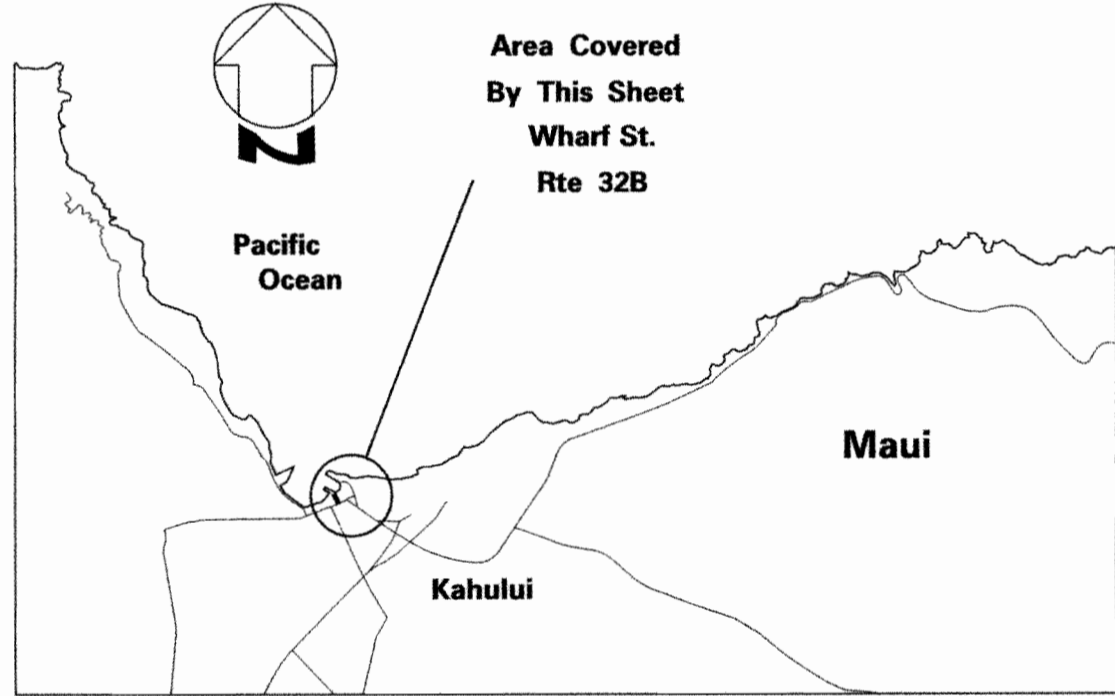

Road Diagram
* MP - Milepost Signage

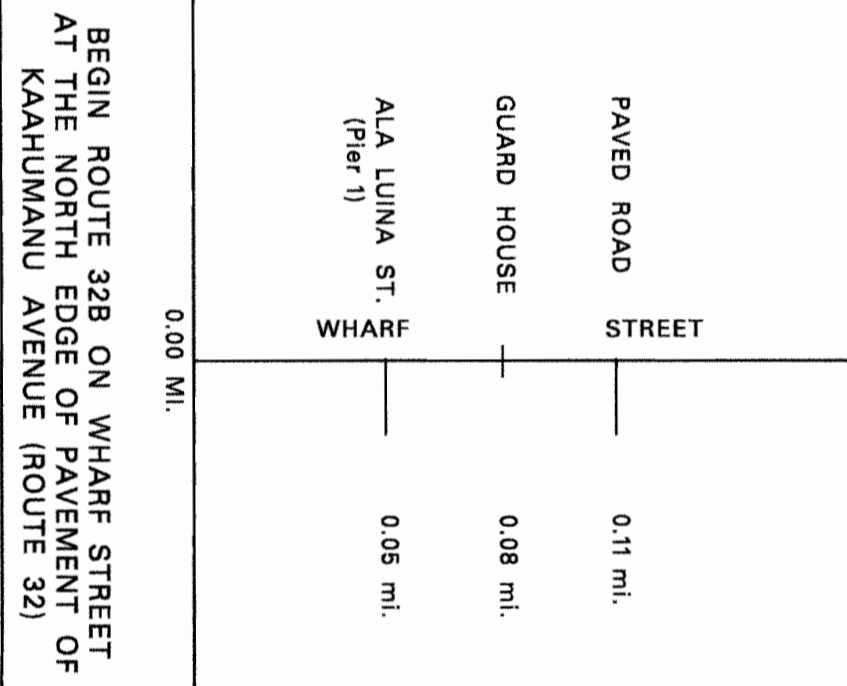

BEGIN ROUTE 32B ON WHARF STREET AT THE NORTH EDGE OF PAVEMENT OF KAAHUMANU AVENUE (ROUTE 32) 0.00 MI.
 END ROUTE 32B ON WHARF STREET AT THE SOUTH BOUNDARY OF THE HARBORS DIVISION LOT AT PIER #2 0.17 MI.

SCALE: (In Miles) 20" = 1 mile

0.0	0.10	0.20	0.30	0.40	0.50	0.60	0.70	0.80	0.90	1.00
-----	------	------	------	------	------	------	------	------	------	------

Undivided Highway	Shoulder: Width and Type	2' AC	10' AC	30'-50' AC
	Pavement: Width and Type	24' AC	44' AC	36' AC
Divided Highway	Shoulder: Width and Type	2' AC	4' AC	40'-50' AC
	Median: Width and Type			
Divided Highway	Shoulder: Width and Type			
	Pavement: Width and Type			
Divided Highway	Shoulder: Width and Type			
	Pavement: Width and Type			
Number of Traffic Lanes		2-12	1-12	1-16
Auxiliary Lanes and Parking Lanes: No. of Lanes and Width (Left Side)		12 T.L.	1-28'	1-20'
(Right Side)				
Frontage Road: No. of Lanes, and Width (Right and Left)				
Sidewalk: Width and Type (Right and Left)		8" CONC		
Curb and/or Gutter: Type (Right and Left)		8" CONC	CONC. CURB & AC GUTTER	
Protective Devices: Type, Location and Number				
Illumination: Type, Location and Number				
Curves: Degree of Curvature (Right and Left)				
Superelevation (Range)				
Grades: % Grade, Positive or Negative				
Vertical Curve: Crest or Sag, Curve Limits				
Area and Development:			SMALL URBAN (99998)	
Terrain: 1-Flat, 2-Rolling, 3-Mountainous			FLAT (1)	
Speed: 1-Design, 2-Posted			20 MPH (2)	
Intersection Control Devices: Type, Location and Cycle Timing				
Traffic Stations (Current Year)			874 032B 00000	
HPMS Sections - AADT 2011			870	
HPMS Sections - AADT 2010			596	
HPMS Sections - AADT 2009			590	
DOD Sections				
Census Tracts				
Functional Classification			PRINCIPAL ARTERIAL (3)	
National Highway System (NHS)			ON NHS (1)	
Previous Projects: Project No., Date and Limits				
			WDR 34 (1) COUNTY PROJECT	

SCALE: (In Miles) 20" = 1 mile

0.0	0.10	0.20	0.30	0.40	0.50	0.60	0.70	0.80	0.90	1.00
-----	------	------	------	------	------	------	------	------	------	------

Date Released	Revised
Oct. 2004, G.N.	
Nov. 06 D.B.	
Feb. 11 D.B.	
Feb. 12 D.B.	
Sept. 12 E.P.J.	

ROAD INVENTORY MAUI RTE 36 HANA HIGHWAY

STATE OF HAWAII
DEPARTMENT OF TRANSPORTATION
HIGHWAYS DIVISION

PREPARED BY THE
HIGHWAYS PLANNING BRANCH
IN COOPERATION WITH THE
U.S. DEPARTMENT OF TRANSPORTATION
FEDERAL HIGHWAY ADMINISTRATION

Total Route Length: 16.23 miles
a. Survey Length: 16.23 miles
b. Proposed Length: 0.00 miles
c. Other Length: * 0.00 miles

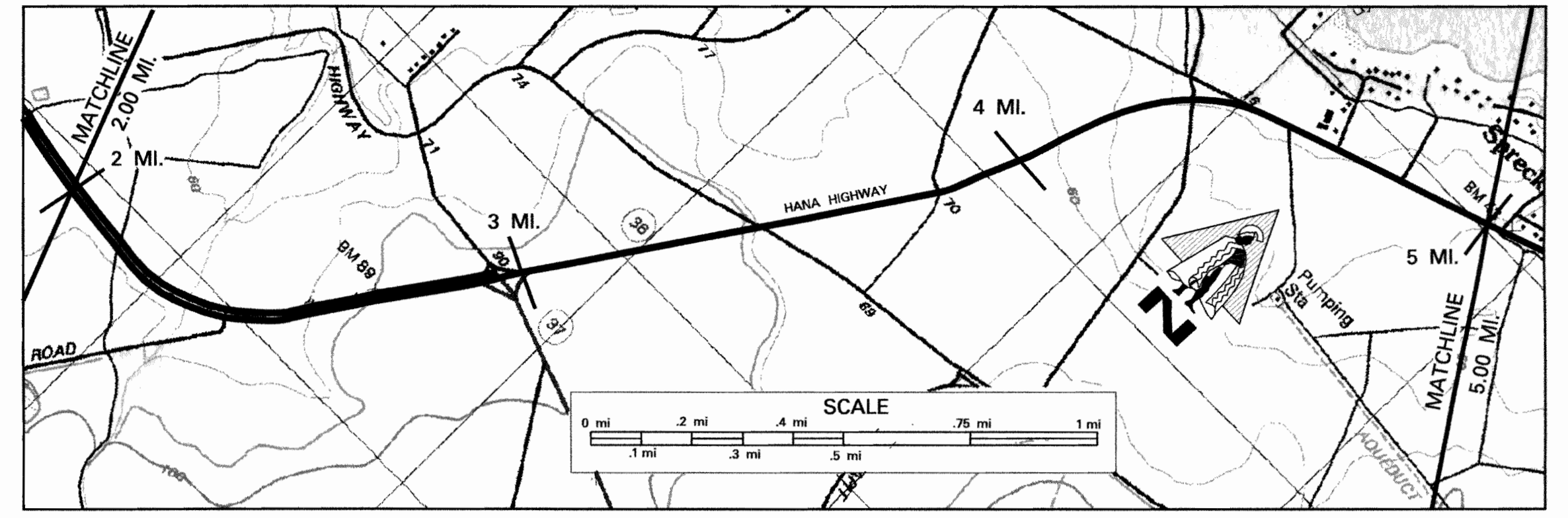
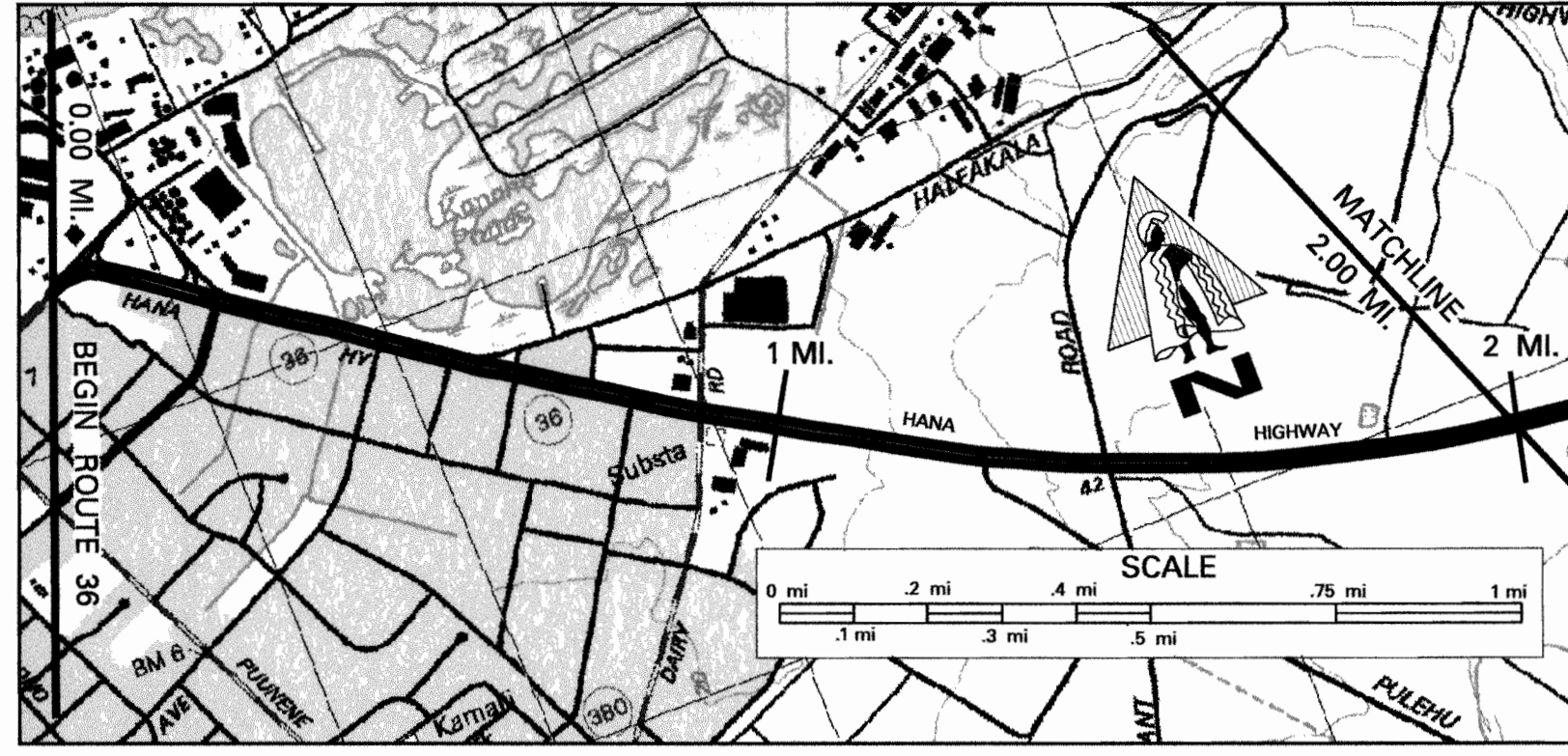

SCALE: (In Miles) 4" = 1 mile

Maintenance Control Sections : Length and Description

0 Begin 36A same as begin Route 36 1 2 3 36A (6.70 MI) 4 5

Structure Carrying Road	Bridges (Over 20'): Length, Type, Capacity and Year Constructed	TEE BEAM 1944 H20 53' PRESTRESSED CONCRETE GIRDER 1991 HS-20-44
	Vertical Clearance	105'
Structure Over Road	Horizontal Clearance	60'
	Vertical Clearance	
Right of Way Width (min.-max.) if varies		100' - 168'
Available Right of Way Width (Needs Study)		URBAN/RESIDENTIAL AREA BOUNDARY 1000' CLR - SUGAR CANE FIELD 20' FROM PAVEMENT
Right of Way Fence: Type - Right and Left		NONE
Control of Access: 1-None, 2-Partial, 3-Full		NONE
Jurisdiction, Transfer Phase No. and Date (C to S or S to C)		STATE
Project No., Type of Construction, and Year Constructed		NH-036-1(17), PREV. MAINT., 2010
Project No., Type of Construction, and Year Constructed		NH-036-1(16), RESURFACE, 2010

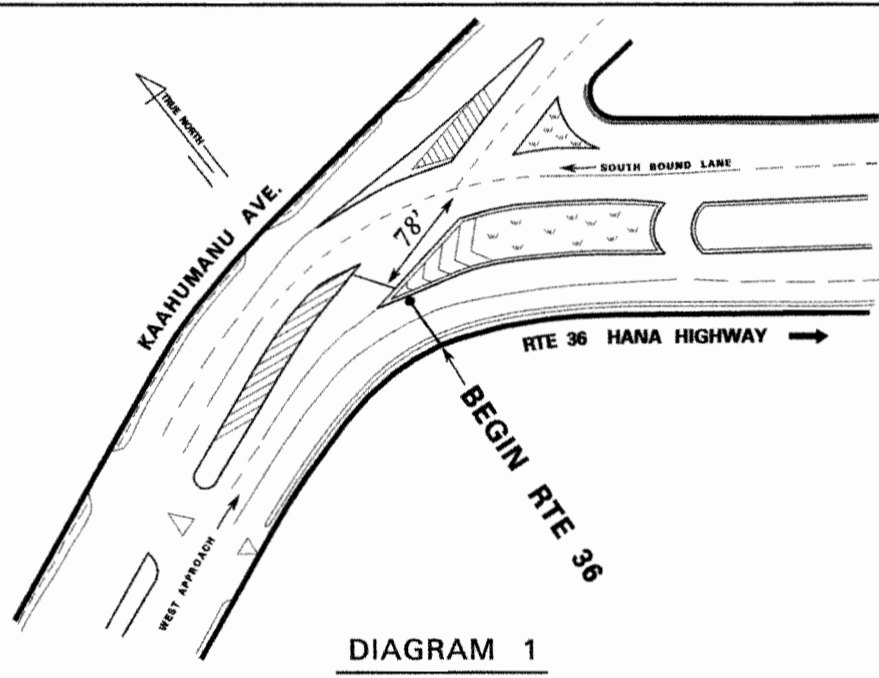

Road Diagram
* MP = Milepost Signage

BEGIN ROUTE 36 ON THE WEST APPROACH TO HANA HWY 78' FROM THE CENTERLINE OF THE SOUTH BOUND LANE OF KAHUIMANU AVENUE (ROUTE 32). (SEE DIAGRAM 1)

0.00 mi.	0.02 mi.	0.27 mi.	0.37 mi.	0.43 mi.	0.52 mi.	0.62 mi.	0.73 mi.	0.78 mi.	0.87 mi.	0.88 mi.	0.97 mi.	1.07 mi.	1.27 mi.	1.42 mi.	1.43 mi.	1.70 mi.	1.80 mi.	2.01 mi.	2.19 mi.	2.29 mi.	2.37 mi.	2.46 mi.	2.68 mi.	2.81 mi.	2.92 mi.	3.00 mi.	3.21 mi.	3.39 mi.	3.44 mi.	3.79 mi.	4.01 mi.	4.16 mi.	4.38 mi.	4.38 mi.	4.65 mi.	4.73 mi.	4.84 mi.	5.00 mi.
----------	----------	----------	----------	----------	----------	----------	----------	----------	----------	----------	----------	----------	----------	----------	----------	----------	----------	----------	----------	----------	----------	----------	----------	----------	----------	----------	----------	----------	----------	----------	----------	----------	----------	----------	----------	----------	----------	----------

SCALE: (In Miles) 4" = 1 mile

Shoulder: Width and Type	6' AC	10' AC	6' AC	6' AC	36' AC	24' AC	12' AC	24' AC	12' AC
	22' AC	24' AC	0'	0'	0'	0'	0'	0'	0'
Pavement: Width and Type	4' AC	6' AC	4' CONC. MEDIAN GUTTER	4' CONC. MEDIAN GUTTER	4' CONC. MEDIAN GUTTER	4' CONC. MEDIAN GUTTER	4' CONC. MEDIAN GUTTER	4' CONC. MEDIAN GUTTER	4' CONC. MEDIAN GUTTER
Median: Width and Type	42' GRASS	VARIES 16'-24' GRASS	VARIES 20'-24' GRASS	VARIES 10'-20' PAINTED AC	VARIES 10'-14' GRASS	VARIES 12'-20' PAINTED AC	VARIES 12'-20' PAINTED AC	VARIES 12'-20' PAINTED AC	VARIES 12'-20' PAINTED AC
Shoulder: Width and Type	4' AC	6' AC	0'	0'	6' AC	0'	0'	0'	0'
Pavement: Width and Type	6' AC	24' AC	6' AC	36' AC	24' AC	24' AC	24' AC	24' AC	24' AC
Shoulder: Width and Type	6' AC	10' AC	6' AC	6' AC	6' AC	8' - 10' AC	8' - 10' AC	8' - 10' AC	8' - 10' AC
Number of Traffic Lanes	2 - 11'	2 - 12'	2 - 12'	2 - 12'	2 - 12'	2 - 12'	2 - 12'	2 - 12'	2 - 12'
Auxiliary Lanes and Parking Lanes: No. of Lanes and Width (Left Side)									
Auxiliary Lanes and Parking Lanes: No. of Lanes and Width (Right Side)									
Frontage Road: No. of Lanes, and Width (Right and Left)									
Sidewalk: Width and Type (Right and Left)									
Curb and/or Gutter: Type (Right and Left)									
Protective Devices: Type, Location and Number									
Illumination: Type, Location and Number									
Curves: Degree of Curvature (Right and Left)									
Superelevation (Range)									
Grades: % Grade, Positive or Negative									
Vertical Curve: Crest or Sag, Curve Limits									
Area and Development:									
Terrain: 1-Flat, 2-Rolling, 3-Mountainous									
Speed: 1-Design, 2-Posted									
Intersection Control Devices: Type, Location and Cycle Timing									
Traffic Stations (Current Year)									
HPMS Sections - AADT 2011									
HPMS Sections - AADT 2010									
HPMS Sections - AADT 2009									
DOD Sections									
Census Tracts									
Functional Classification									
National Highway System (NHS)									
Previous Projects: Project No., Date and Limits									

SCALE: (In Miles) 4" = 1 mile

Date Released	Oct. 2004, G.N.
Revised	Feb. 06 D.B. Nov. 06 D.B. Mar. 08 D.B. Dec. 09 D.B. Feb. 11 D.B. Sept. 12 E.P.F.

ROAD INVENTORY MAUI RTE 36 HANA HIGHWAY

STATE OF HAWAII
DEPARTMENT OF TRANSPORTATION
HIGHWAYS DIVISION
PREPARED BY THE
HIGHWAYS PLANNING BRANCH
IN COOPERATION WITH THE
U.S. DEPARTMENT OF TRANSPORTATION
FEDERAL HIGHWAY ADMINISTRATION

Total Route Length:	16.23	miles
a. Survey Length:	16.23	miles
b. Proposed Length:	0.00	miles
c. Other Length: *	0.00	miles

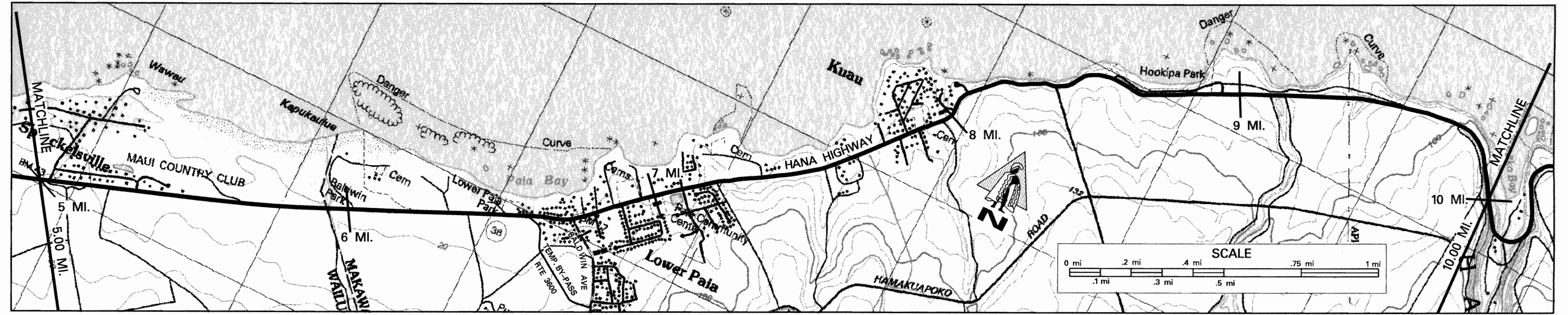

SCALE: (In Miles) 4" = 1 mile

Maintenance Control Sections : Length and Description

Structure Carrying Road	Bridges (Over 20'): Length, Type, Capacity and Year Constructed
	Vertical Clearance
	Horizontal Clearance
	Vertical Clearance
Structure Over Road	Vertical Clearance
	Horizontal Clearance

Right of Way Width (min.-max.) if varies	60'	80' - 200'
Available Right of Way Width (Needs Study)	1000' CLR - SUGAR CANE FIELD 20' FROM PAVEMENT	1000' CLR (R) 15' SUGAR CANE FROM PAVEMENT / BEACH (L)
Right of Way Fence: Type - Right and Left	NONE	NONE
Control of Access: 1-None, 2-Partial, 3-Full	NONE	NONE
Jurisdiction, Transfer Phase No. and Date (C to S or S to C)	STATE	STATE
Project No., Type of Construction, and Year Constructed	36AB-01-04M, RESURFACE, 2005	36AB-01-04M, RESURFACE, 2005
Project No., Type of Construction, and Year Constructed	36AB-01-90M, RESURFACE 1991	36BC-01-10M, PREV. MAINT., 2011
Project No., Type of Construction, and Year Constructed	STP-0900(58), GUARDRAIL & SHOULDER IMPR., 2004	STP-036-1(8) RESURFACE 1998

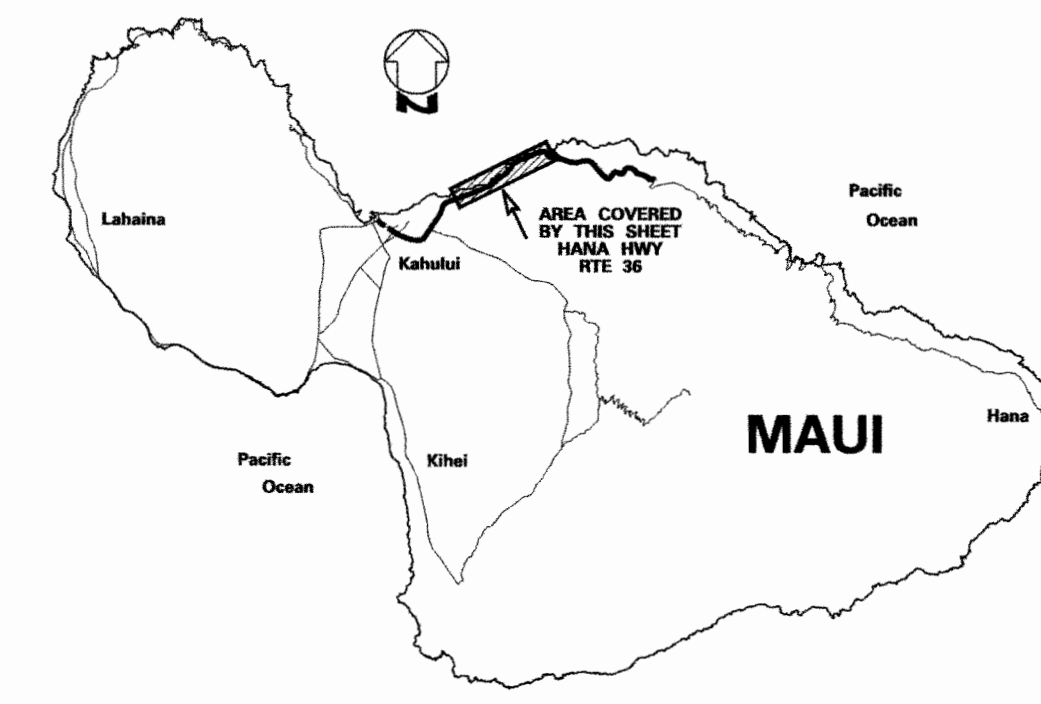

Road Diagram
* MP = Milepost Signage

SCALE: (In Miles) 4" = 1 mile

Undivided Highway	Shoulder: Width and Type	12' AC	6'-8" AC	24' AC	4' AC	12' AC	24' AC	11' AC	22' AC	12' AC	24' AC
	Pavement: Width and Type	0'	4' AC	0'	4' AC	0'	4' AC	6' GRASS	4' AC	6' GRASS	5' - 6' AC
Divided Highway	Median: Width and Type	12' PAINT AC	5.11'	0'	6.03'	0'	7.15'	0'	0'	0' - 10' PAINTED AC	6' AC
	Shoulder: Width and Type	0'	0'	0'	0'	0'	0'	6' GRASS	6' AC	0'	6' AC
	Pavement: Width and Type	12' AC	6'-8" AC	12' AC	6'-10" AC	11' AC	6' GRASS	6' GRASS	6' AC	12' AC	6' AC

Number of Traffic Lanes	2 - 12'	2 - 11'	2 - 12'	2 - 11'	2 - 12'
Auxiliary Lanes and Parking Lanes: No. of Lanes and Width (Left Side)					
(Right Side)					
Frontage Road: No. of Lanes, and Width (Right and Left)					
Sidewalk: Width and Type (Right and Left)					
Curb and/or Gutter: Type (Right and Left)					
Protective Devices: Type, Location and Number					
Illumination: Type, Location and Number					
Curves: Degree of Curvature (Right and Left)					
Shoulder Lanes					
Grades: % Grade, Positive or Negative	1	0	1	0	+3
Vertical Curve: Crest or Sag, Curve Limits					
Area and Development:					
Terrain: 1-Flat, 2-Rolling, 3-Mountainous	FLAT (1)			RURAL (99999)	ROLLING (2)
Speed: 1-Design, 2-Posted	35 MPH (2)	45 MPH (2)	35 MPH (2)	20 MPH (2)	30 MPH (2)
Intersection Control Devices: Type, Location and Cycle Timing					

Traffic Stations (Current Year)	B74 0036 00321	B74 0036 00654	B74 0036 00893	B74 0036 00971
HPMS Sections - AADT 2011	17,200	15,759	11,900	11,443
HPMS Sections - AADT 2010	17,400	14,904	11,413	10,821
HPMS Sections - AADT 2009	19,000	14,757	11,300	10,714
DOD Sections				
Census Tracts				
Functional Classification				
National Highway System (NHS)				
Previous Projects: Project No., Date and Limits	36AB-01-90M RESURFACE 1991	36AB-01-90M RESURFACE 1991	36AB-01-90M RESURFACE 1991	STP-036-1(7) 1997
	NRS-17A 1933	36AB-01-75 (RESURF) 1975	36B-02-79 (IMPROV) 1979	36BC-01-92M (RESURF) 1982
			JOB # 5213	WDRG 14(1) 1948
				F-036-1(1) REVAMP 1961
				F-036-1(1) 1959

SCALE: (In Miles) 4" = 1 mile

ROUTE CONTINUES ON SHEET #3

Date Released	Oct. 2004, G.N.
Revised	
Feb. 06	D.B.
Nov. 06	D.B.
Mar. 08	D.B.
Jan. 10	D.B.
Feb. 11	D.B.
Feb. 12	D.B.
Sept. 12	E.P.J.

ROAD INVENTORY
MAUI RTE 36
HANA HIGHWAY

STATE OF HAWAII
 DEPARTMENT OF TRANSPORTATION
 HIGHWAYS DIVISION

PREPARED BY THE
 HIGHWAYS PLANNING BRANCH
 IN COOPERATION WITH THE
 U.S. DEPARTMENT OF TRANSPORTATION
 FEDERAL HIGHWAY ADMINISTRATION

Total Route Length: 16.23 miles
a. Survey Length: 16.23 miles
b. Proposed Length: 0.00 miles
c. Other Length: * 0.00 miles

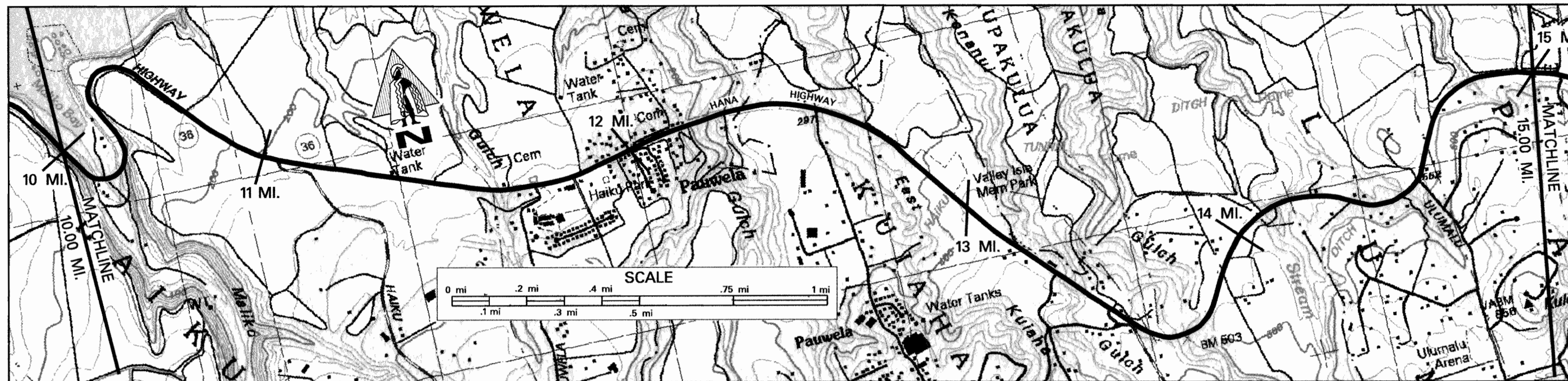

SCALE: (In Miles) 4" = 1 mile

Maintenance Control Sections : Length and Description	36B (4.32 MI)	End 36B, Begin 36C at the centerline intersection of Hana Hwy and Kakomo-Haiku Road	36C (5.21 MI)	
Structure Carrying Road	TEE BEAM 1961 205' HS20			PRESTRESSED CONCRETE GIRDER, HL-93, 2003
Vertical Clearance	28'			225' 34'
Horizontal Clearance				
Right of Way Width (min.-max.) if varies	80' - 200'		80' - 285'	80' - 135'
Available Right of Way Width (Needs Study)	CUT SLOPES	TREES AND BUSHES	TREES	CUT SLOPES WITH PASTURES AND FARMS
Right of Way Fence: Type - Right and Left				
Control of Access: 1-None, 2-Partial, 3-Full			NONE	
Jurisdiction, Transfer Phase No. and Date (C to S or S to C)			STATE	
Project No., Type of Construction, and Year Constructed			36BC-01-10M, PREV. MAINT., 2011	
Project No., Type of Construction, and Year Constructed		STP - 036 - 1(8) RESURFACE 1998	STP - 090 (39), 1996 RESURFACE	(BR-036-116), 2003 BRIDGE REPLACEMENT STP - 0900 (39), 1996 RESURFACE

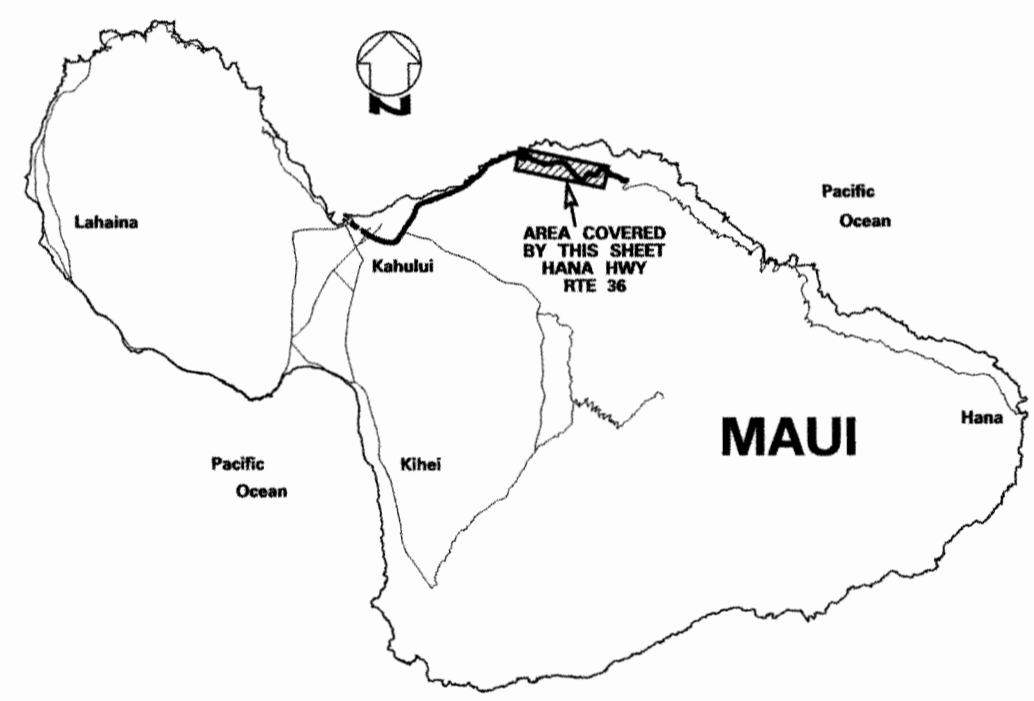

Road Diagram
 * MP = Milepost Signage

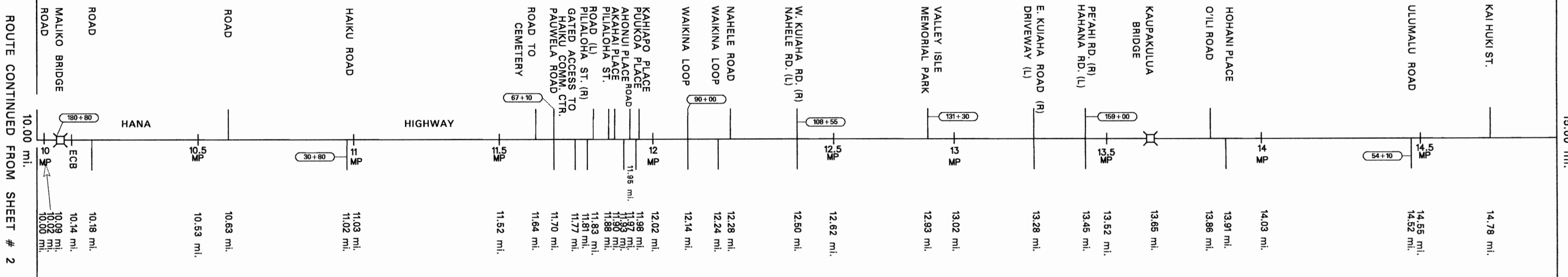

SCALE: (In Miles) 4" = 1 mile

Divided Highway	Shoulder: Width and Type		6' AC		4' - 6' AC		10' AC		4' - 6' AC
	Pavement: Width and Type	24' AC		22' AC		24' AC		22' AC	
Undivided	Shoulder: Width and Type		5' - 6' AC		4' - 6' AC		10' AC		4' - 6' AC
	Median: Width and Type								
Number of Traffic Lanes		2 - 12'			2 - 11'		2 - 12'		2 - 11'
Auxiliary Lanes and Parking Lanes: No. of Lanes and Width (Left Side)									
(Right Side)									
Frontage Road: No. of Lanes, and Width (Right and Left)									
Sidewalk: Width and Type (Right and Left)									
Curb and/or Gutter: Type (Right and Left)	4' CONC. GUTTER	4' CONC. GUTTER	4' CONC. GUTTER	3' CONC. GUTTER	3' AC	12' CONC. GUTTER	12' CONC. GUTTER	3' CONC. GUTTER	12' CONC. GUTTER
Protective Devices: Type, Location and Number									
Illumination: Type, Location and Number									
Curves: Degree of Curvature (Right and Left)									
Superelevation (Range)									
Grades: % Grade, Positive or Negative			4			7			
Vertical Curve: Crest or Sag, Curve Limits									
Area and Development:		RURAL (99999)		SMALL URBAN (99998)					
Terrain: 1-Flat, 2-Rolling, 3-Mountainous		MOUNTAINOUS (3)		ROLLING (2)					
Speed: 1-Design, 2-Posted		35 MPH (2)	45 MPH (2)	30 MPH (2)	45 MPH (2)	45 MPH (2)	30 MPH (2)	35 MPH (2)	35 MPH (2)
Intersection Control Devices: Type, Location and Cycle Timing									
Traffic Stations (Current Year)		(874 0036 00971)	874 0036 01009	874 0036 01102	874 0036 01170	874 0036 01214	874 0036 01345	874 0036 01391	
HPMS Sections - AADT 2011		(11,443)	11,700	7,900	9,826	7,156	6,622	3,800	
HPMS Sections - AADT 2010		(10,821)	11,413	7,777	9,292	6,767	6,262	3,232	
HPMS Sections - AADT 2009		(10,714)	11,300	7,700	9,200	6,700	6,200	3,200	
DOD Sections									
Census Tracts									
Functional Classification					MINOR ARTERIAL (4)				
National Highway System (NHS)					NOT ON NHS (0)				
Previous Projects: Project No., Date and Limits		F-036-1(1) 1961 REVAMP	36BC-01-82M 1982 RESURFACE	STP-036-1(7) 1997	0.34	STP - 090 (39), 1996 RESURFACE	36C-01-87M 1987 RESURFACE	F - 32 (2) 1957	F - 32 (2) 1946

SCALE: (In Miles) 4" = 1 mile

Date Released	Oct 2004 GN
Revised	
Feb. 06	D.B.
Nov. 06	D.B.
Jan. 10	D.B.
Feb. 11	D.B.
Feb. 12	D.B.
Sept. 12	E.P.J.

ROAD INVENTORY MAUI RTE 36 HANA HIGHWAY

STATE OF HAWAII
DEPARTMENT OF TRANSPORTATION
HIGHWAYS DIVISION
PREPARED BY THE
HIGHWAYS PLANNING BRANCH
IN COOPERATION WITH THE
U.S. DEPARTMENT OF TRANSPORTATION
FEDERAL HIGHWAY ADMINISTRATION

Total Route Length: 16.23 miles
a. Survey Length: 16.23 miles
b. Proposed Length: 0.00 miles
c. Other Length: * 0.00 miles

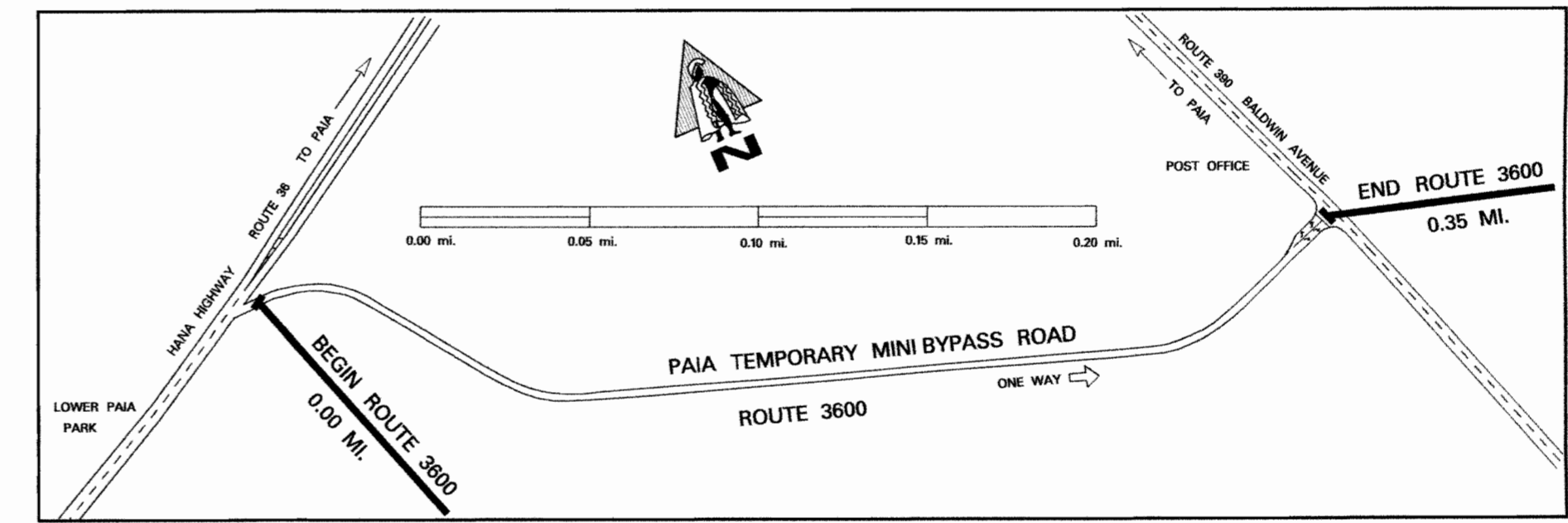
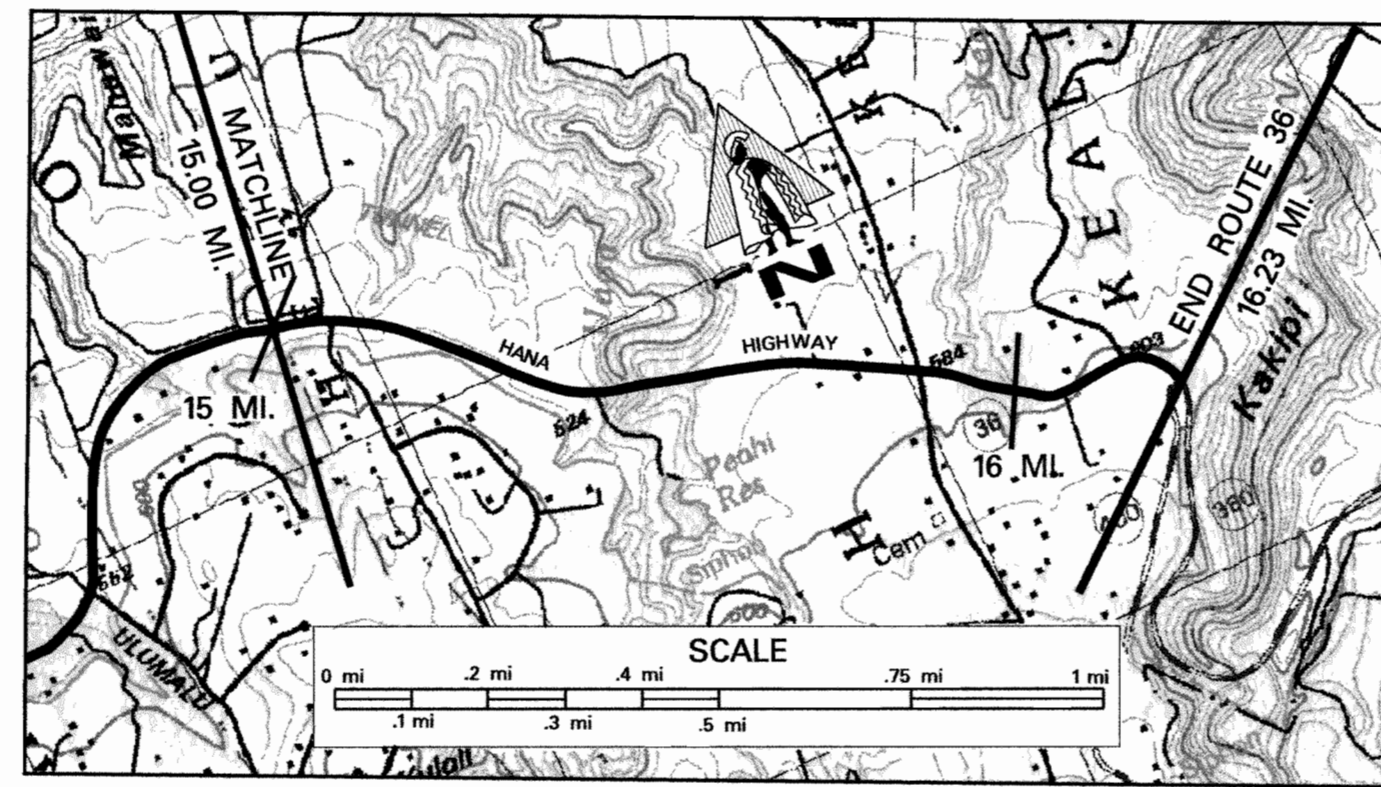

SCALE: (In Miles) 4" = 1 mile

Maintenance Control Sections : Length and Description	15	16	17	0	.10	.20	.30	.40	.50
Structure Carrying Road	36C (5.21 MI) END 36C SAME AS END ROUTE 36								
Bridges (Over 20'): Length, Type, Capacity and Year Constructed	Prestressed Concrete Girder HL-93, 2002 315'								
Vertical Clearance	80' - 135'								
Horizontal Clearance	CUT SLOPES W/PASTURES & FARMS								
Right of Way Width (min.-max.) if varies	NONE								
Available Right of Way Width (Needs Study)	STATE								
Right of Way Fence: Type - Right and Left	PRIVATE								
Control of Access: 1-None, 2-Partial, 3-Full									
Jurisdiction, Transfer Phase No. and Date (C to S or S to C)									
Project No., Type of Construction, and Year Constructed	36BC-01-10M, PREV. MAINT., 2011								
Project No., Type of Construction, and Year Constructed	STP-0900(39), 1996 RESURFACE; BR-036-114, 2002 Bridge Replacement; STP-0900(29), 1996 RESURFACE								

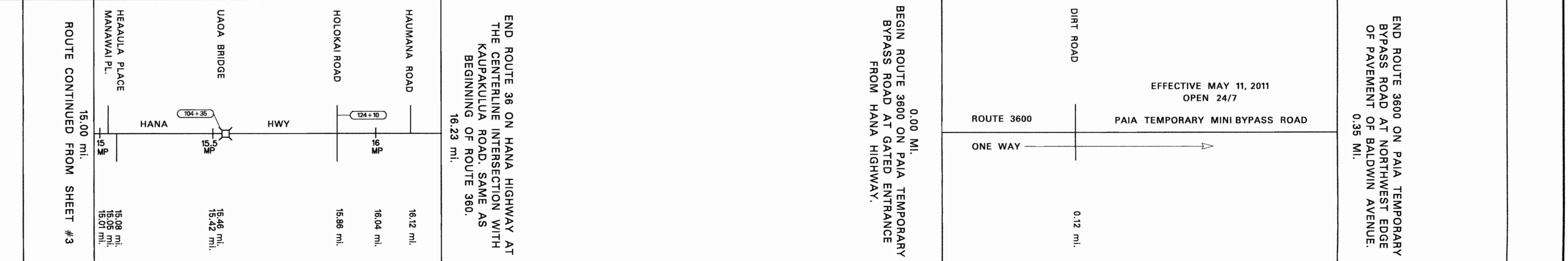
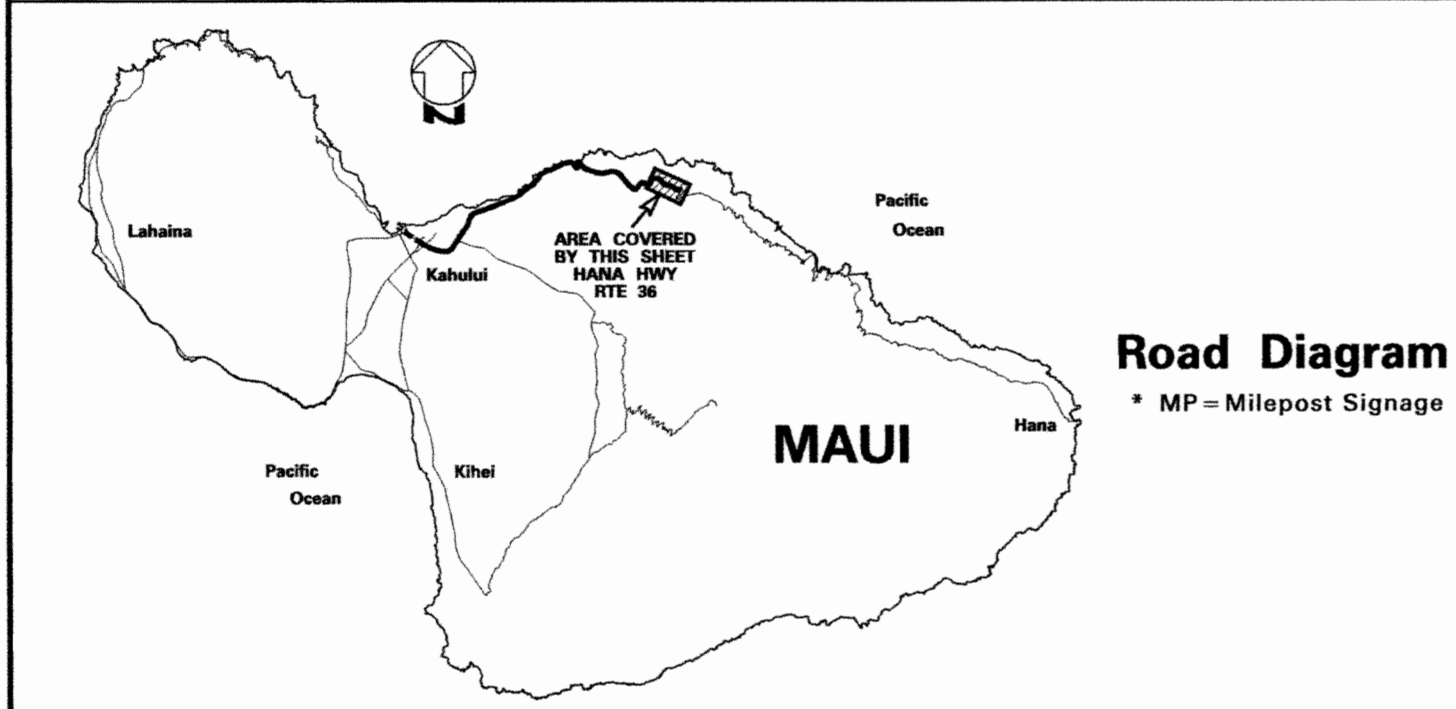

SCALE: (In Miles) 4" = 1 mile

Divided Highway	15	16	17	0.0	0.1	0.2	0.3	0.4	0.5
Shoulder: Width and Type	4' - 6' AC								
Pavement: Width and Type	22' AC; 24' AC; 22' AC								
Shoulder: Width and Type	4' - 6' AC								
Median: Width and Type									
Shoulder: Width and Type									
Pavement: Width and Type									
Shoulder: Width and Type									
Number of Traffic Lanes	2 - 11'; 2 - 12'; 2 - 11'								
Auxiliary Lanes and Parking Lanes: No. of Lanes and Width (Left Side)	NONE								
(Right Side)	NONE								
Frontage Road: No. of Lanes, and Width (Right and Left)	NONE								
Sidewalk: Width and Type (Right and Left)									
Curb and/or Gutter: Type (Right and Left)	4' CONC. GUTTER; 2' CONC. GUTTER								
Protective Devices: Type, Location and Number	METAL ON CONCRETE								
Illumination: Type, Location and Number									
Curves: Degree of Curvature (Right and Left)									
Superelevation (Range)									
Grades: % Grade, Positive or Negative									
Vertical Curve: Crest or Sag, Curve Limits									
Area and Development:	SMALL URBAN (99998); ROLLING (2); RURAL (99999); FLAT (1)								
Terrain: 1-Flat, 2-Rolling, 3-Mountainous									
Speed: 1-Design, 2-Posted	35 MPH (2); 20 MPH (2); 25 MPH (2)								
Intersection Control Devices: Type, Location and Cycle Timing									
Traffic Stations (Current Year)	874 0036 01391								
HPMS Sections - AADT 2011	3,600								
HPMS Sections - AADT 2010	3,232								
HPMS Sections - AADT 2009	3,200								
DOD Sections									
Census Tracts									
Functional Classification	MINOR ARTERIAL (4); PRIVATE (26)								
National Highway System (NHS)	NOT ON NHS (0); NOT NHS (0)								
Previous Projects: Project No., Date and Limits	STP-0900(39), 1996 RESURFACE; 36C-01-87M 1987 RESURFACE; F-32(2) 1957; F-32(2) 1946								

SCALE: (In Miles) 4" = 1 mile

Date Released	Revised
Oct 2004 GN	
Feb. 06 D.B.	
Nov. 06 D.B.	
Mar. 08 D.B.	
Mar. 09 D.B.	
Jan. 10 D.B.	
Feb. 11 D.B.	
Feb. 12 D.B.	
Sept. 12 E.P.J.	

ROAD INVENTORY MAUI RTE 36A HALEAKALA HWY., KEOLANI PL.

STATE OF HAWAII
DEPARTMENT OF TRANSPORTATION
HIGHWAYS DIVISION

PREPARED BY THE
HIGHWAYS PLANNING BRANCH
IN COOPERATION WITH THE
U.S. DEPARTMENT OF TRANSPORTATION
FEDERAL HIGHWAY ADMINISTRATION

Total Route Length: 0.51 miles
a. Survey Length: 0.51 miles
b. Proposed Length: 0.00 miles
c. Other Length: * 0.00 miles

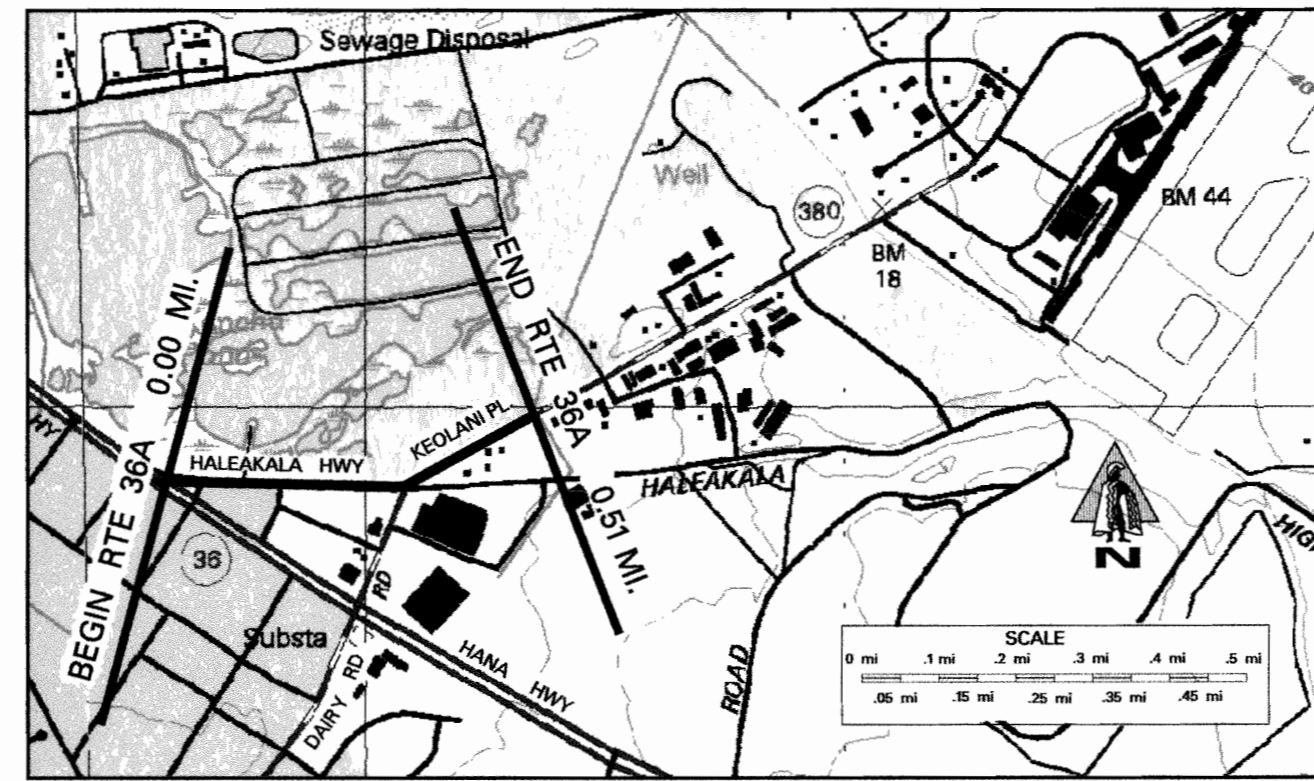

Maintenance Control Sections : Length and Description	SCALE: (In Miles) 20" = 1 mile	0.0 0.10 0.20 0.30 0.40 0.50 0.60 0.70 0.80 0.90 1.00
	Begin 36A-A on Haleakala Highway at the N.E. edge of pavement of Hana Hwy.	36A - A
		End 36A-A at centerline of Dairy Road

Structure Carrying Road	Bridges (Over 20'): Length, Type, Capacity and Year Constructed	
	Vertical Clearance	
	Horizontal Clearance	
Structure Not Carrying Road	Vertical Clearance	
	Horizontal Clearance	
Right of Way Width (min.-max.) if varies		
Available Right of Way Width (Needs Study)		
Right of Way Fence: Type - Right and Left		
Control of Access: 1-None, 2-Partial, 3-Full		
Jurisdiction, Transfer Phase No. and Date (C to S or S to C)		
Project No., Type of Construction, and Year Constructed		
COUNTY HWY-M-01-05M, RESURF., 2006 HWY-M-01-91M 1992 (RESURFACE) HWY-M-01-76M 1976		

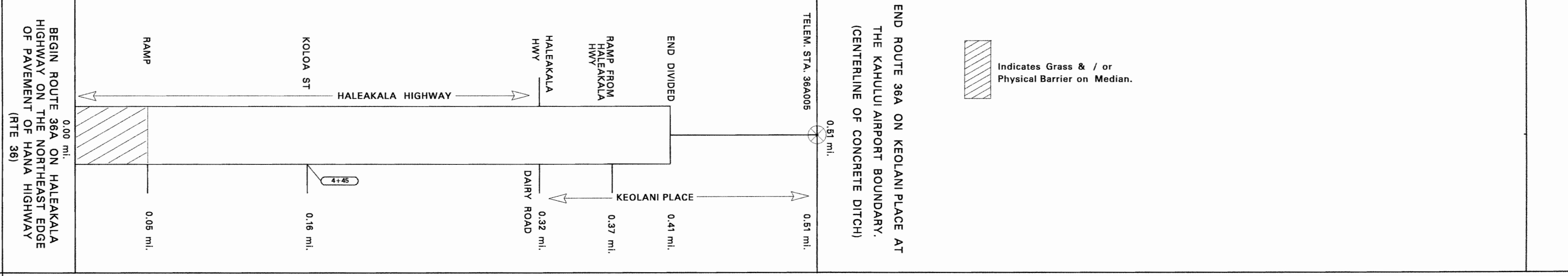
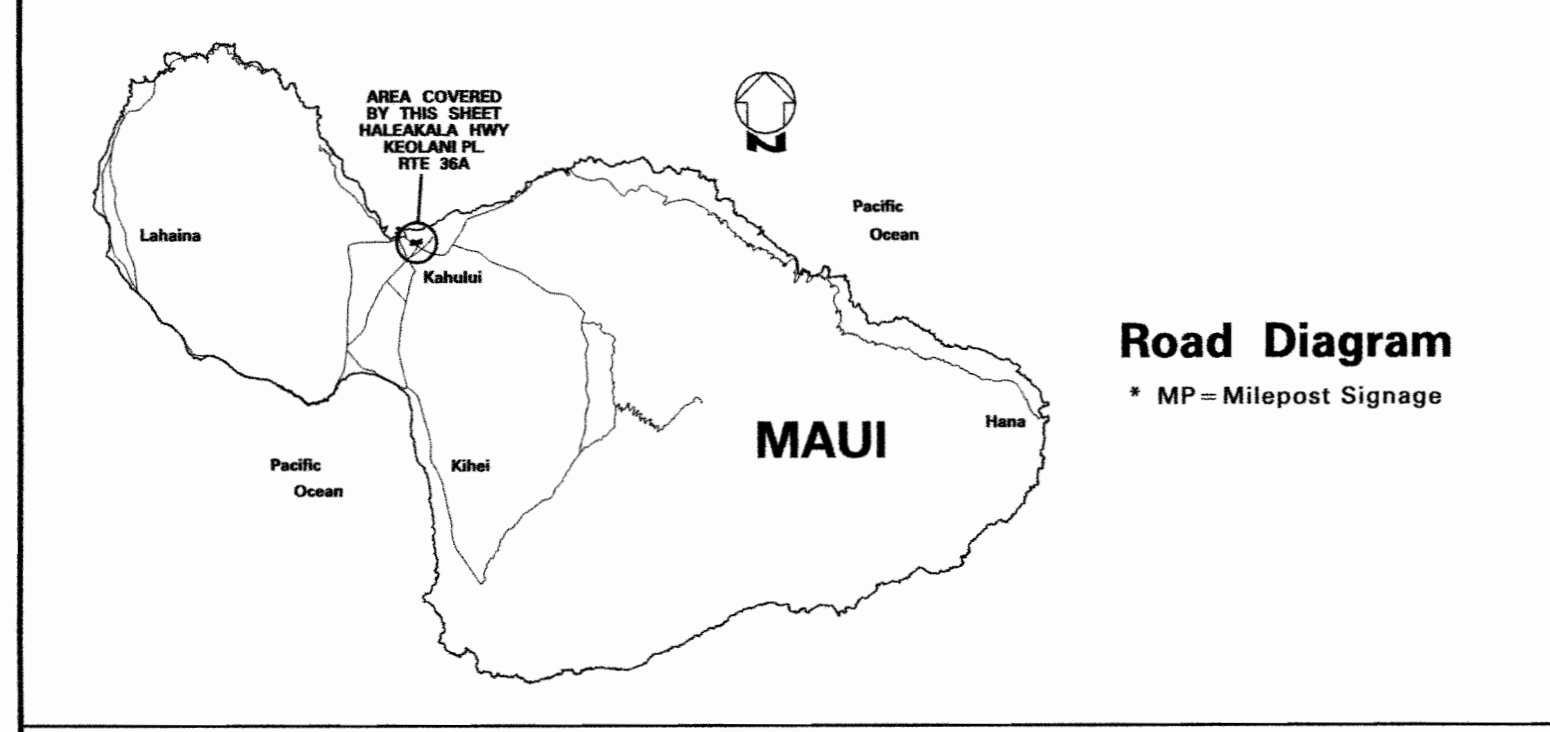

Unimproved	Shoulder: Width and Type		0' 6' AC		6' BP WITH CURB		10' GRASS		6' AC		10' GRAVEL		25' GRAVEL	
Divided Highway	Pavement: Width and Type		12' BP		24' AC		12' AC		10' AC		30' AC			
	Shoulder: Width and Type		0' 6' AC		0'		10' GRASS							
	Median: Width and Type		VARIES GRASS W/CONC CURB		0' - 12' PAINTED AC									
	Shoulder: Width and Type		12' BP		12' AC		0'		20' AC		12' GRASS			
	Pavement: Width and Type													
	Shoulder: Width and Type													
Number of Traffic Lanes			2 - 12'		1 - 10'		2 - 10'							
Auxiliary Lanes and Parking Lanes: No. of Lanes and Width (Left Side)														
(Right Side)														
Frontage Road: No. of Lanes, and Width (Right and Left)														
Sidewalk: Width and Type (Right and Left)					6' Concrete Sidewalk									
Curb and/or Gutter: Type (Right and Left)			Conc. Curb		Concrete Curb and Gutter									
Protective Devices: Type, Location and Number														
Illumination: Type, Location and Number														
Curves: Degree of Curvature (Right and Left)														
Superelevation (Range)														
Grades: % Grade, Positive or Negative														
Vertical Curve: Crest or Sag, Curve Limits														
Area and Development:					SMALL URBAN (99998)									
Terrain: 1-Flat, 2-Rolling, 3-Mountainous					FLAT (1)									
Speed: 1-Design, 2-Posted					30 MPH (2)									
Intersection Control Devices: Type, Location and Cycle Timing														
Traffic Stations (Current Year)					874 036A 00000				874 036A 00032					
HPMS Sections - AADT 2011					7,100				13,200					
HPMS Sections - AADT 2010					6,161				12,524					
HPMS Sections - AADT 2009					6,100				12,400					
DOD Sections														
Census Tracts														
Functional Classification					MINOR ARTERIAL (4)									
National Highway System (NHS)					NOT ON NHS (0)									
Previous Projects: Project No., Date and Limits														
									HWY-M-01-76M 1976					
					COUNTY				NRS-17A 1933 AND 1934					

Date Released	Oct 2004 GN
Revised	
Sept. 04	D.B.
Nov. 06	D.B.
Jan. 10	D.B.
Feb. 11	D.B.
Feb. 12	D.B.
Sept. 12	E.P.J.

ROAD INVENTORY MAUI RTE 37 HALEAKALA HWY & KULA HWY

STATE OF HAWAII
DEPARTMENT OF TRANSPORTATION
HIGHWAYS DIVISION
PREPARED BY THE
HIGHWAYS PLANNING BRANCH
IN COOPERATION WITH THE
U.S. DEPARTMENT OF TRANSPORTATION
FEDERAL HIGHWAY ADMINISTRATION

Total Route Length: 21.35 miles
 a. Survey Length: 21.35 miles
 b. Proposed Length: 0.00 miles
 c. Other Length: * 0.00 miles

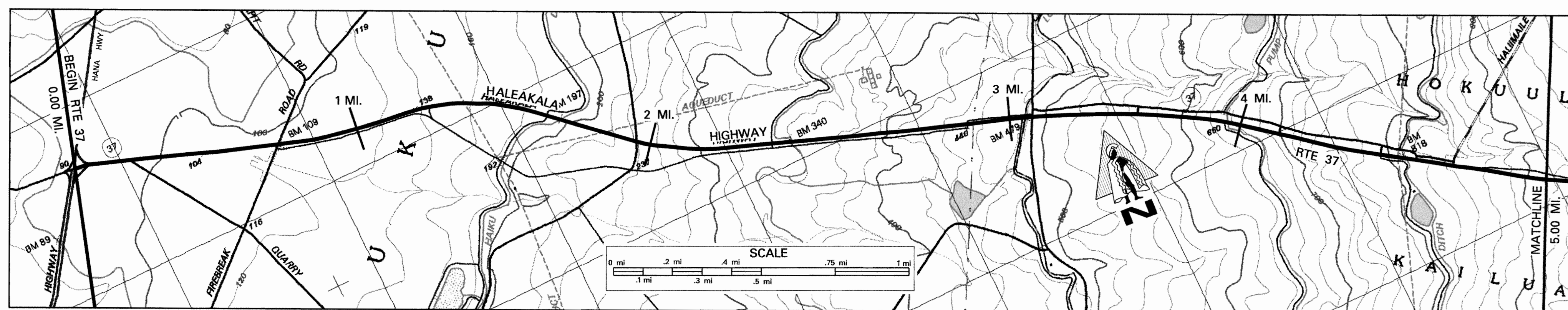

SCALE: (In Miles) 4" = 1 mile

Maintenance Control Sections : Length and Description	0	1	2	3	4	5
Begin 37B on Haleakala Highway at the centerline intersection with Hana Highway						End 37B - Begin 37C on Haleakala Hwy at the centerline with Hallimale Road
Structure Carrying Road	CONCRETE CULVERT 1973 HS-20					
Vertical Clearance	35'					
Horizontal Clearance	48'					
Right of Way Width (min.-max.) if varies	50'	60'	60'	120' - 140'	140' - 200'	
Available Right of Way Width (Needs Study)	CLEAR 1000' - SUGAR CANE 30' FROM EDGE OF PAVEMENT					
Right of Way Fence: Type - Right and Left	NONE					
Control of Access: 1-None, 2-Partial, 3-Full	STATE					
Jurisdiction, Transfer Phase No. and Date (C to S or S to C)	NONE					
Project No., Type of Construction, and Year Constructed	NH-037-1(24), WIDENING, 2009					
Project No., Type of Construction, and Year Constructed	37D-01-90 (TRUCK CLIMBING LANE) 1991					

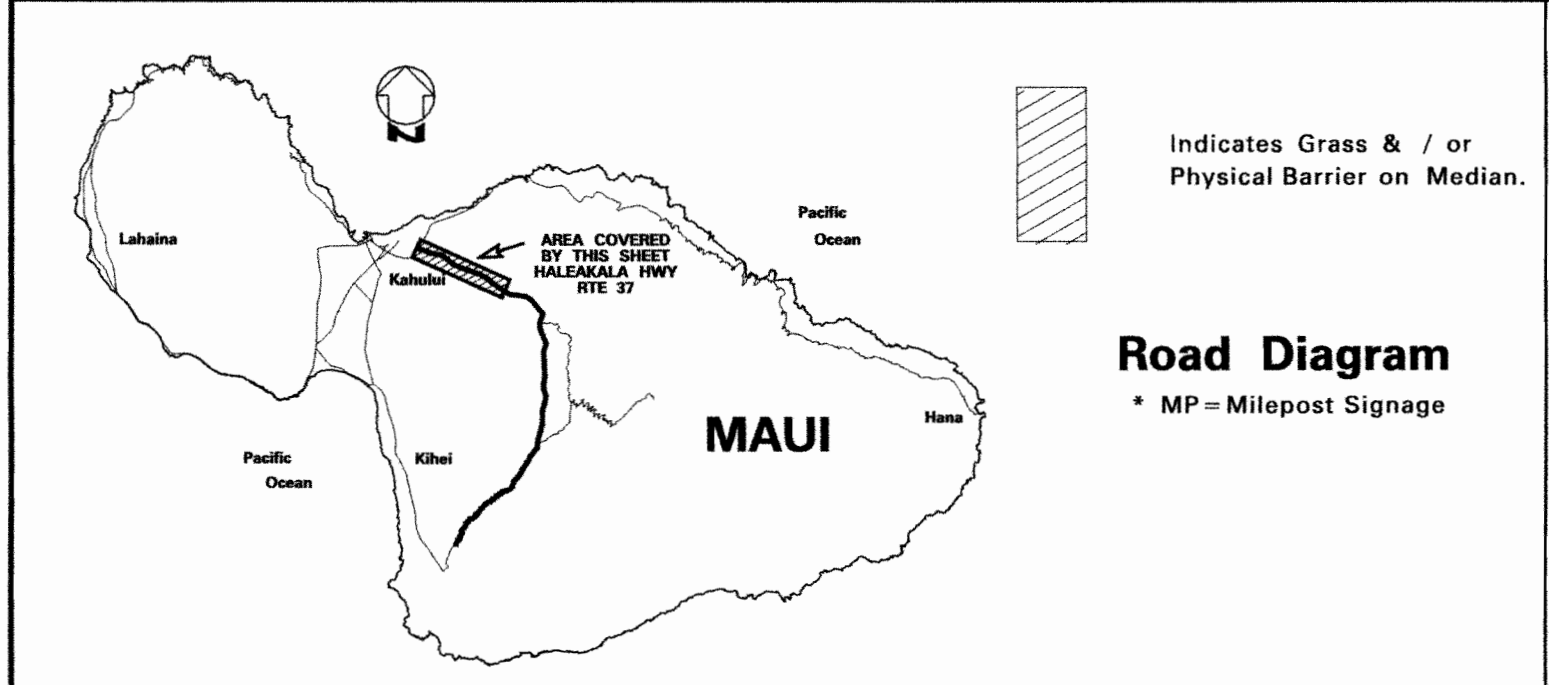

SCALE: (In Miles) 4" = 1 mile

Divided Highway	0	1	2	3	4	5
Shoulder: Width and Type	6' AC - 4' GRASS					
Pavement: Width and Type	24' AC					
Shoulder: Width and Type	4' AC					
Median: Width and Type	12' - 24' GRASS					
Shoulder: Width and Type	8' AC					
Pavement: Width and Type	24' PCC					
Shoulder: Width and Type	6' AC					
Number of Traffic Lanes	4-12'					
Auxiliary Lanes and Parking Lanes: No. of Lanes and Width (Left Side)	1-12' AC					
(Right Side)	1-12' (L) TL					
Frontage Road: No. of Lanes, and Width (Right and Left)						
Sidewalk: Width and Type (Right and Left)						
Curb and/or Gutter: Type (Right and Left)						
Protective Devices: Type, Location and Number	M/C = metal rails on concrete post					
Illumination: Type, Location and Number						
Curves: Degree of Curvature (Right and Left)						
Superelevation (Range)						
Grades: % Grade, Positive or Negative	CONTRA FLOW, EVES, 3:30 - 6:00 PM					
Vertical Curve: Crest or Sag, Curve Limits	TRAFFIC FLOW (coning begins here)					
Area and Development:	CONTRA FLOW, MORN., 5:30 - 8:30 AM					
Terrain: 1-Flat, 2-Rolling, 3-Mountainous	SMALL URBAN (99998)					
Speed: 1-Design, 2-Posted	FLAT (1)					
Intersection Control Devices: Type, Location and Cycle Timing	35 MPH (1), 45 MPH (1), 55 MPH (1), 45 MPH (1), 55 MPH (1), 45 MPH (1), 55 MPH (1)					
Traffic Stations (Current Year)	B74 0037 00000, B74 0037 00091, B74 0037 00476					
HPMS Sections - AADT 2011	28,200, 28,300, 12,300					
HPMS Sections - AADT 2010	29,088, 30,616, 19,800					
HPMS Sections - AADT 2009	28,800, 30,313, 19,800					
DOD Sections	DOD 710					
Census Tracts	DOD 710					
Functional Classification	PRINCIPAL ARTERIAL (3)					
National Highway System (NHS)	ON NHS (1)					
Previous Projects: Project No., Date and Limits	0.04 NH-037-1(22), 2004, HALEAKALA HWY WIDENING 0.91, 36A-01-82 1983 (INTER IMPROV) 0.06, 0.10 37CD-01-80M 1980 (RESURFACE) 0.69, FAP E-5E 1933 0.65, 0.08 FAP E-5E 1932 0.70, 37D-01-90 (TRUCK CLIMBING LANE) 1991 4.76, F-037-1(7) 1972 4.94					

SCALE: (In Miles) 4" = 1 mile

Date Released	Revised
Oct 2004 GN	
Feb. 06 D.B.	
Nov. 06 D.B.	
Feb. 08 D.B.	
May 10 D.B.	
Feb. 11 D.B.	
Feb. 12 D.B.	
Feb. 13 E.P.J.	

ROAD INVENTORY MAUI RTE 37 HALEAKALA HWY & KULA HWY

STATE OF HAWAII
DEPARTMENT OF TRANSPORTATION
HIGHWAYS DIVISION
PREPARED BY THE
HIGHWAYS PLANNING BRANCH
IN COOPERATION WITH THE
U.S. DEPARTMENT OF TRANSPORTATION
FEDERAL HIGHWAY ADMINISTRATION

Total Route Length: 21.35 miles
a. Survey Length: 21.35 miles
b. Proposed Length: 0.00 miles
c. Other Length: * 0.00 miles

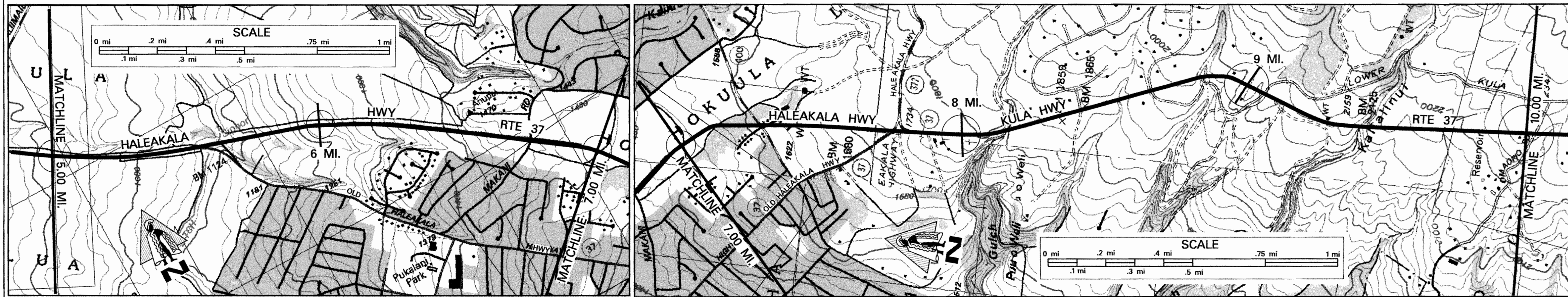

SCALE: (In Miles) 4" = 1 mile

Maintenance Control Sections : Length and Description

Structure Carrying Road	Bridges (Over 20'): Length, Type, Capacity and Year Constructed	37C (9.25 MI)
	Vertical Clearance	CULVERT (2-10') 1964 HS-20 40'
Structure Over Road	Horizontal Clearance	24'
	Vertical Clearance	28'
Right of Way Width (min.-max.) if varies		140' - 200'
Available Right of Way Width (Needs Study)		PASTURE AND RANCH LANDS
Right of Way Fence: Type - Right and Left		ALL WIRE ON WOOD
Control of Access: 1-None, 2-Partial, 3-Full		NONE
Jurisdiction, Transfer Phase No. and Date (C to S or S to C)		STATE
Project No., Type of Construction, and Year Constructed		NH-037-1(24), 2009, WIDENING (HWY-M-01-06M, RESURF., 2007) (STP-037-1(23), INTERSECTION IMPR., 2007) (HWY-M-01-06M, RESURF., 2007) 37CD-01-02M, REPAIR & MAINT., 2004
Project No., Type of Construction, and Year Constructed		37C-02-90, 1993, NEW ALIGNMENT (292+30) (40+70) (52+70) (82+00) (118+50) (159+80) (326+00) STP-037-1(18) RESURFACE 1994 STP-037-1(21) RESURFACE 1999

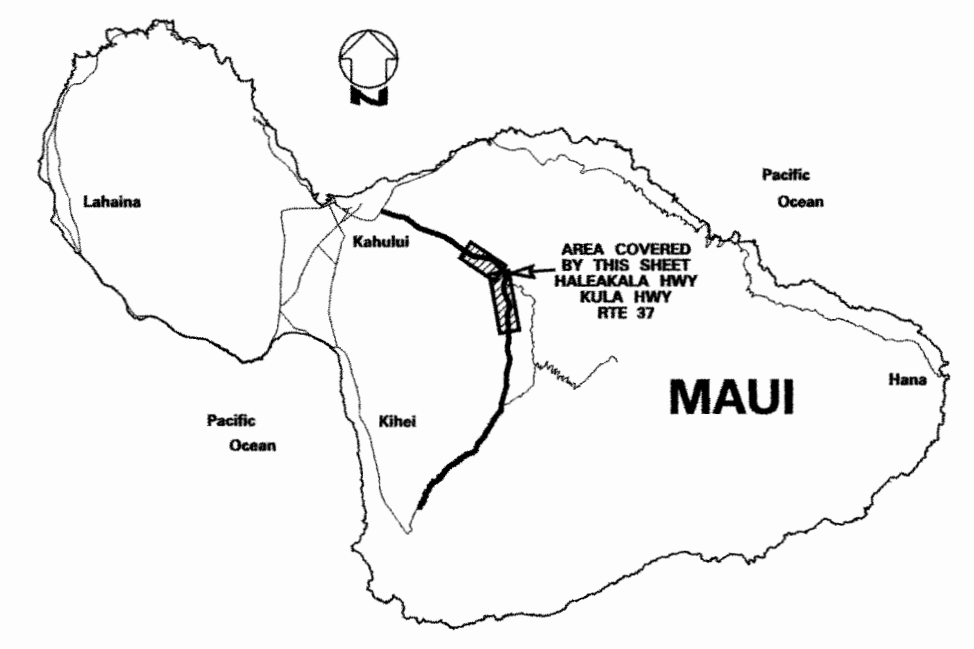

Road Diagram
* MP = Milepost Signage

SCALE: (In Miles) 4" = 1 mile

Divided Highway	Shoulder: Width and Type	10' AC	10' AC	10' AC	10' AC	10' AC	10' AC	6' AC	6' AC		
	Pavement: Width and Type	24' AC	48' AC	12' AC	36' AC	12' AC	12' AC	12' AC	24' AC		
	Shoulder: Width and Type	4' AC	0'	6'-10' AC	0'	10' AC	0'	0'	0'	6' AC	
	Median: Width and Type	12'-24' GRASS	24'-0' PAINT AC	8' PAINT AC	12' PAINT AC	12' PAINT AC	12' PAINT AC	12' PAINT AC	0'	0'	
	Shoulder: Width and Type	8' AC	0'	0'	0'	0'	0'	0'	0'	0'	
Pavement: Width and Type		24' PCC	24' AC	24' AC	24' AC	24' AC	24' AC	12' AC	12' AC		
Shoulder: Width and Type		6' AC	6'-10' AC	10' AC	10' AC	10' AC	10' AC	6' AC	6' AC		
Number of Traffic Lanes		4-12'		1-12'		1-12' AND 1-12' TRUCK CLIMBING LANE		2-12'			
Auxiliary Lanes and Parking Lanes: No. of Lanes and Width (Left Side)											
(Right Side)											
Frontage Road: No. of Lanes, and Width (Right and Left)											
Sidewalk: Width and Type (Right and Left)											
Curb and/or Gutter: Type (Right and Left)		ALL GUTTERS 2' AC									
Protective Devices: Type, Location and Number				M/M		M/M		M/C			
Illumination: Type, Location and Number											
Curves: Degree of Curvature (Right and Left)											
Superelevation (Range)											
Grades: % Grade, Positive or Negative											
Vertical Curve: Crest or Sag, Curve Limits		CONTRA FLOW LANES									
Area and Development:		CONTRA FLOW 5:30 - 8:30 AM ← TRAFFIC		SMALL URBAN (99998)				RURAL (99999)			
Terrain: 1-Flat, 2-Rolling, 3-Mountainous		FLAT (1)		ROLLING (2)							
Speed: 1-Design, 2-Posted		45 MPH (2)		3 PHASE		3 PHASE		45 MPH (2)			
Intersection Control Devices: Type, Location and Cycle Timing											
Traffic Stations (Current Year)		B74 0037 00476		B74 0037 00564		B74 0037 00747		B74 0037 00776		B74 0037 00940	
HPMS Sections - AADT 2011		12,300		13,457		11,900		12,923		11,500	
HPMS Sections - AADT 2010		19,998		12,726		13,266		12,221		12,423	
HPMS Sections - AADT 2009		19,800		12,800		13,135		12,100		12,300	
DOD Sections		5.94		7.5		7.8		9.40			
DOD 705											
DOD 700											
Census Tracts											
Functional Classification				ON NHS (1)		PRINCIPAL ARTERIAL (3)				MAJOR COLLECTOR (5)	
National Highway System (NHS)										NOT ON NHS (0)	
Previous Projects: Project No., Date and Limits		37C-02-90, 1993, NEW ALIGNMENT 5.66		37C-01-92 1993 NEW ALIGNMENT (PHASE II) 6.70 6.73 → 6.85 ← (37C-01-97, 1998) 6.65		2.80		37CD-01-02M, REPAIR & MAINT., 2004		STP-037-1(18) 1996 (6" SHLDR & GUARD RAILS) 9.04	
		37C-02-90 1993 (NEW ALIGNMENT)				37C-02-82 INTER. IMPROV.		37C-01-88M 1988 RESURFACE		BF-037-1(1) 1962	
				37C-01-81M 1981 (RESURFACE) 6.43 → 6.54		7.54		37C-01-80M 1990 RESURFACE 9.05			
				(37C-01-91 1992 RIGHT TURN LANE) 6.43 → 6.54		7.57					
				WDRC 14(1) 1948		7.15		FAP 58 1929 7.43		← 7.80 → (RF-037-1(4) 1970)	

SCALE: (In Miles) 4" = 1 mile

Date Released	Revised
Oct 2004 GN	
Nov., 06 D.B.	
Feb., 08 D.B.	
Jan., 10 D.B.	
Feb., 11 D.B.	
Feb., 12 D.B.	
Sept. 12 E.P.J.	

ROAD INVENTORY MAUI RTE 37 HALEAKALA HWY. & KULA HWY.

STATE OF HAWAII
DEPARTMENT OF TRANSPORTATION
HIGHWAYS DIVISION

PREPARED BY THE
HIGHWAYS PLANNING BRANCH
IN COOPERATION WITH THE
U.S. DEPARTMENT OF TRANSPORTATION
FEDERAL HIGHWAY ADMINISTRATION

Total Route Length: 21.35 miles
a. Survey Length: 21.35 miles
b. Proposed Length: 0.00 miles
c. Other Length: * 0.00 miles

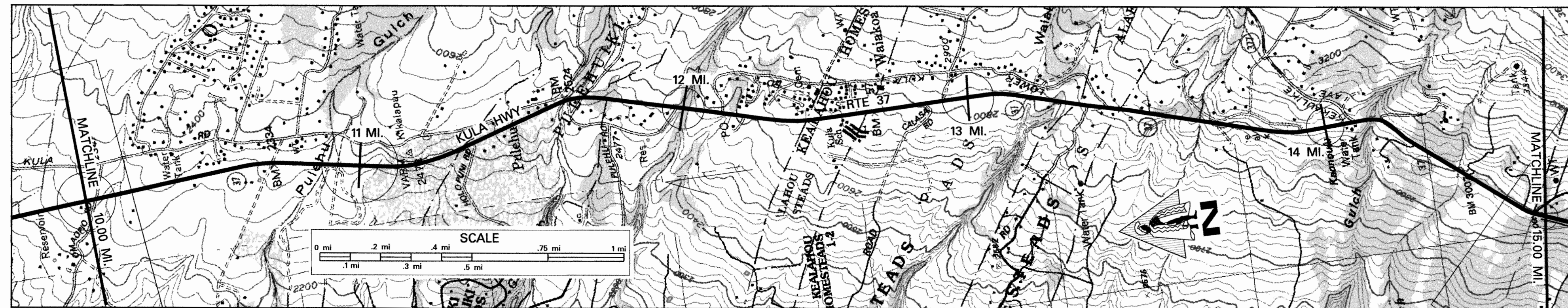

SCALE: (In Miles) 4" = 1 mile

Maintenance Control Sections : Length and Description

37C (9.25 MI) END 37C - BEG. 37D ON KULA HWY AT THE CENTERLINE OF KEKAULU AVE

Structure Carrying Road
 Bridges (Over 20'): Length, Type, Capacity and Year Constructed
 Vertical Clearance
 Horizontal Clearance
Spanning Over Road
 Vertical Clearance
 Horizontal Clearance

PRESTRESSED BEAM 1964, HS-20 164'
 RC DECK GIRDER 1933, H-15 75'
 28'
 24'

Right of Way Width (min.-max.) if varies
Available Right of Way Width (Needs Study)
Right of Way Fence: Type - Right and Left All fences: Wire on Wood (unless indicated)
Control of Access: 1-None, 2-Partial, 3-Full
Jurisdiction, Transfer Phase No. and Date (C to S or S to C)
Project No., Type of Construction, and Year Constructed
Project No., Type of Construction, and Year Constructed

PASTURE AND RANCH LANDS 90' - 270'
 RESIDENTIAL 60'
 NONE STATE
 37CD-01-02M, REPAIR & MAINT., 2004
 37CDE-01-07M, RESURFACE, 2010

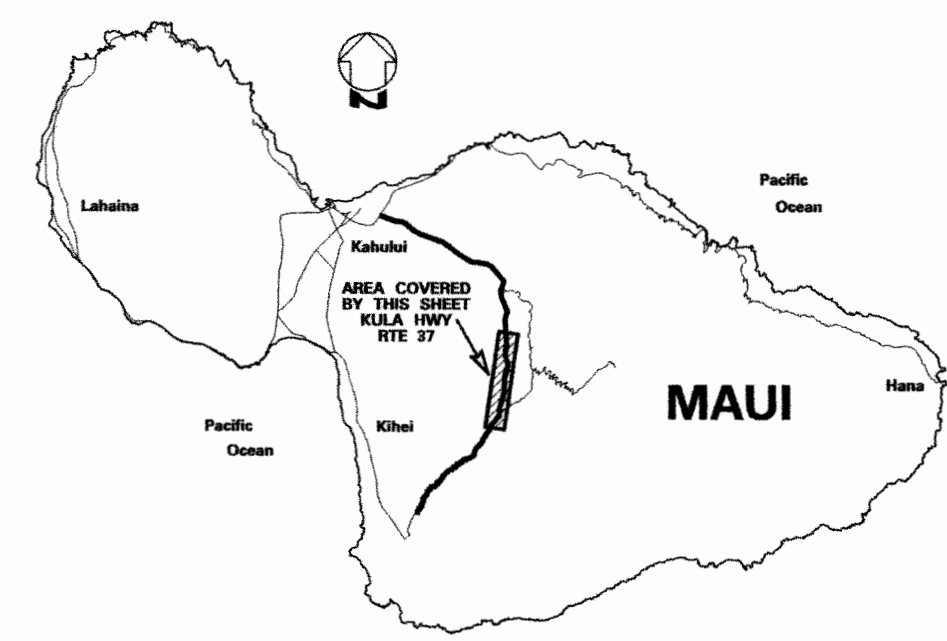

Road Diagram
* MP = Milepost Signage

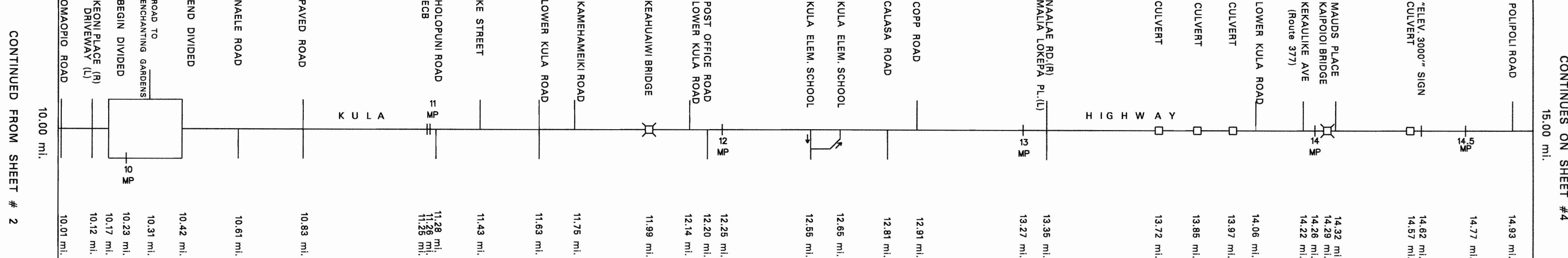

SCALE: (In Miles) 4" = 1 mile

Undivided Highway
 Shoulder: Width and Type
 Pavement: Width and Type
 Shoulder: Width and Type
Divided Highway
 Median: Width and Type
 Shoulder: Width and Type
 Pavement: Width and Type
 Shoulder: Width and Type

24' AC	12' AC	6' AC	24' AC	2' - 6' AC
6' AC	0	6' AC	6' AC	24'-20' AC
30' 17'	12' PAINT	10.42	0	2' - 6' AC
	0			
	12' AC			
	6' AC			

Number of Traffic Lanes
Auxiliary Lanes and Parking Lanes: No. of Lanes and Width (Left Side)
(Right Side)
Frontage Road: No. of Lanes, and Width (Right and Left)
Sidewalk: Width and Type (Right and Left)
Curb and/or Gutter: Type (Right and Left) ALL GUTTERS 2' AC
Protective Devices: Type, Location and Number METAL ON METAL / METAL ON CONCRETE
Illumination: Type, Location and Number
Curves: Degree of Curvature (Right and Left)
Superelevation (Range)
Grades: % Grade, Positive or Negative
Vertical Curve: Crest or Sag, Curve Limits
Area and Development:
Terrain: 1-Flat, 2-Rolling, 3-Mountainous
Speed: 1-Design, 2-Posted
Intersection Control Devices: Type, Location and Cycle Timing
Traffic Stations (Current Year)
HPMS Sections - AADT 2011
HPMS Sections - AADT 2010
HPMS Sections - AADT 2009
DOD Sections
Census Tracts
Functional Classification
National Highway System (NHS)
Previous Projects: Project No., Date and Limits

2 - 12'
 2 - (12'-10')
 CONC. GUTTER
 M/C
 RURAL (99999)
 ROLLING (2)
 45 MPH (2)
 20 MPH (2)
 45 MPH (2)
 35 MPH (2)
 MAJOR COLLECTOR (5)
 NOT ON NHS (0)
 STP-037-(121) RESURFACE 1999
 STP-037-(119) 1996 GUARDRAIL & SHOULDER
 37C-01-88M 1988 RESURFACE
 BF-037-1(1) 1962
 STP-037-(118) WIDEN & RESURFACE 1994
 37D-01-75 1978 WIDEN & RESURFACE
 FAP 13A 1932

SCALE: (In Miles) 4" = 1 mile

Date Released	Revised
Oct 2004 GN	
Nov. 06 D.B.	
Dec. 10 D.B.	
Feb. 11 D.B.	
Feb. 12 D.B.	
Feb. 13 E.P.J.	

ROAD INVENTORY MAUI RTE 37 HALEAKALA HWY & KULA HWY

STATE OF HAWAII
DEPARTMENT OF TRANSPORTATION
HIGHWAYS DIVISION
PREPARED BY THE
HIGHWAYS PLANNING BRANCH
IN COOPERATION WITH THE
U.S. DEPARTMENT OF TRANSPORTATION
FEDERAL HIGHWAY ADMINISTRATION

Total Route Length: 21.35 miles
a. Survey Length: 21.35 miles
b. Proposed Length: 0.00 miles
c. Other Length: * 0.00 miles

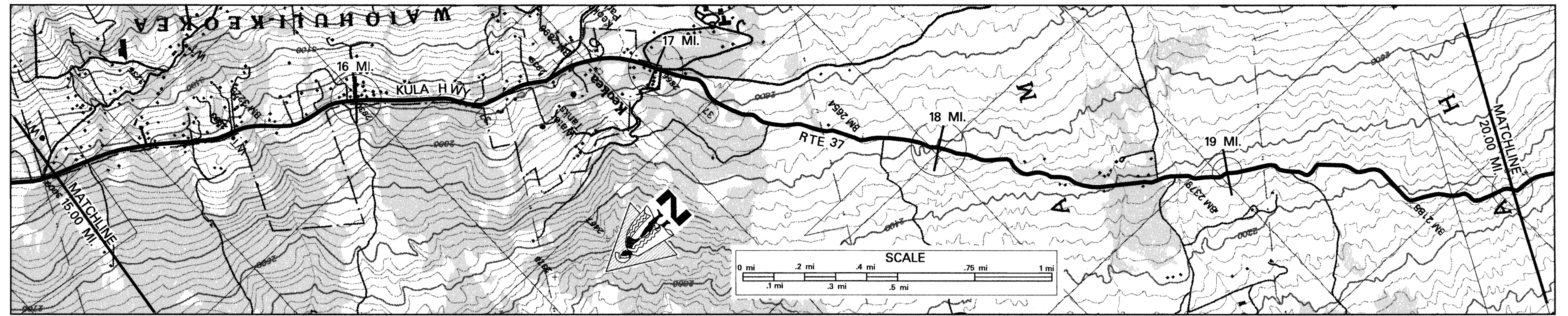

SCALE: (In Miles) 4" = 1 mile

Maintenance Control Sections : Length and Description

Structure Carrying Road	Bridges (Over 20'): Length, Type, Capacity and Year Constructed	
	Vertical Clearance	
Spanning Over Road	Horizontal Clearance	
	Vertical Clearance	
Horizontal Clearance		

Right of Way Width (min.-max.) if varies
Available Right of Way Width (Needs Study)
Right of Way Fence: Type - Right and Left
Control of Access: 1-None, 2-Partial, 3-Full
Jurisdiction, Transfer Phase No. and Date (C to S or S to C)
Project No., Type of Construction, and Year Constructed
Project No., Type of Construction, and Year Constructed

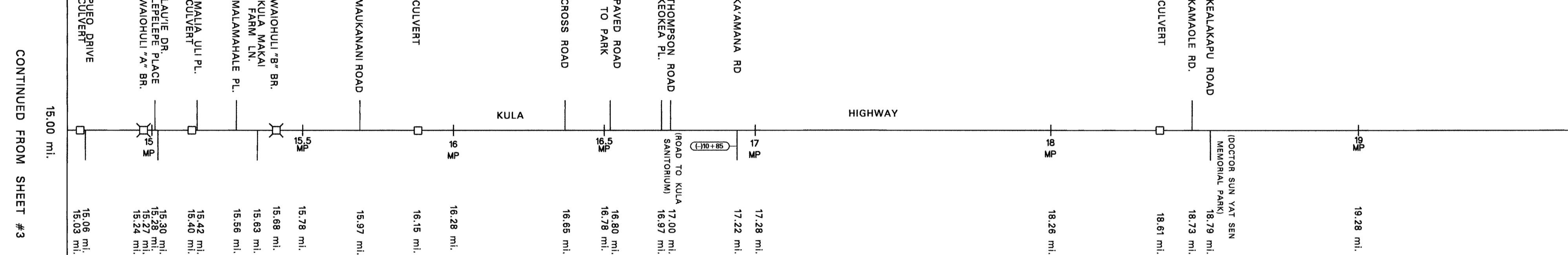
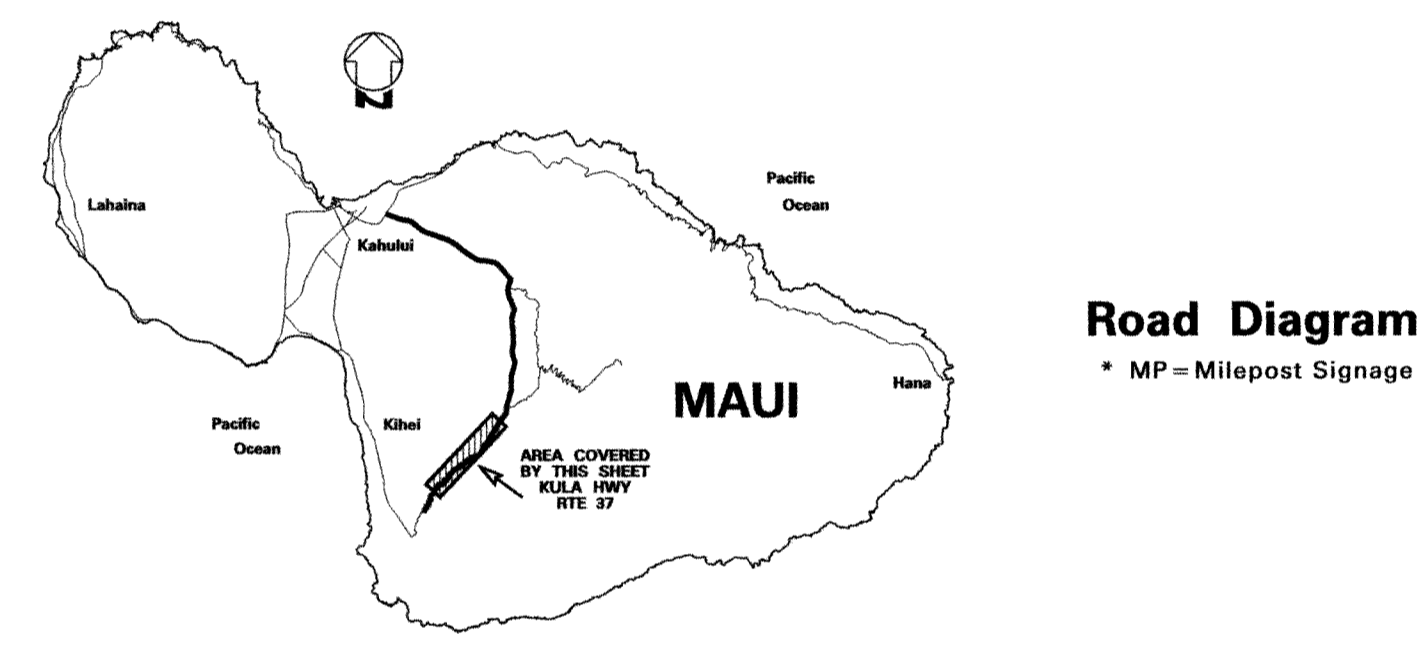
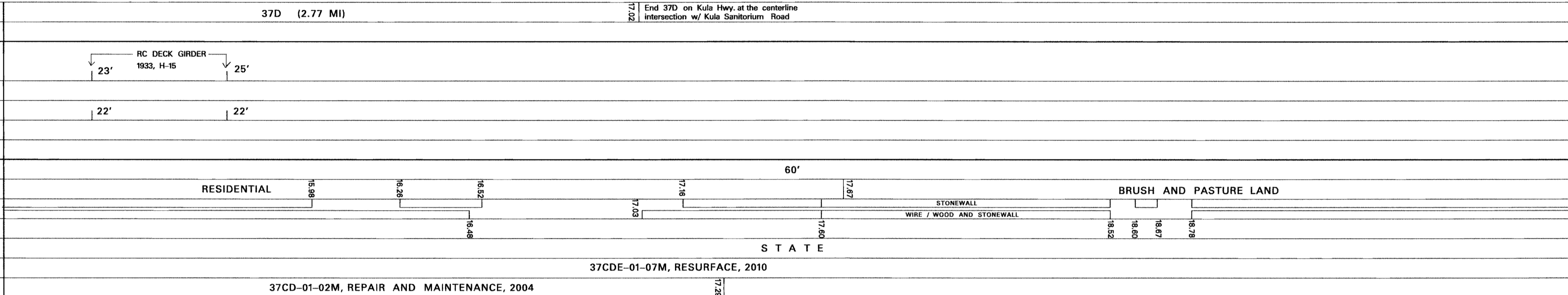

SCALE: (In Miles) 4" = 1 mile

Divided Highway	Shoulder: Width and Type	
	Pavement: Width and Type	
Undivided	Shoulder: Width and Type	
	Median: Width and Type	
Shoulder: Width and Type	Shoulder: Width and Type	
	Pavement: Width and Type	
Shoulder: Width and Type	Shoulder: Width and Type	

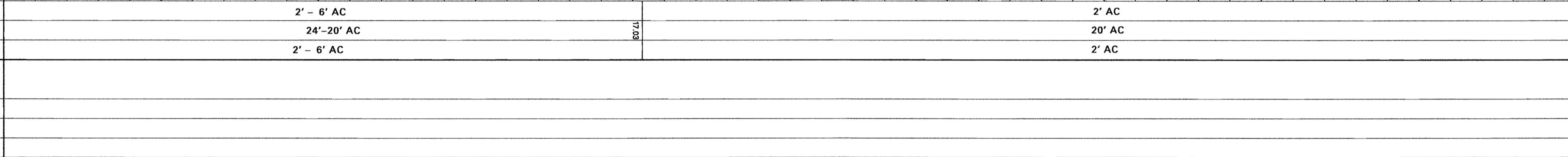

Number of Traffic Lanes
Auxiliary Lanes and Parking Lanes: No. of Lanes and Width (Left Side)
(Right Side)
Frontage Road: No. of Lanes, and Width (Right and Left)
Sidewalk: Width and Type (Right and Left)
Curb and/or Gutter: Type (Right and Left)
Protective Devices: Type, Location and Number
ILLUMINATION: Type, Location and Number
Curves: Degree of Curvature (Right and Left)
Superelevation (Range)
Grades: % Grade, Positive or Negative
Vertical Curve: Crest or Sag, Curve Limits
Area and Development:
Terrain: 1-Flat, 2-Rolling, 3-Mountainous
Speed: 1-Design, 2-Posted
Intersection Control Devices: Type, Location and Cycle Timing

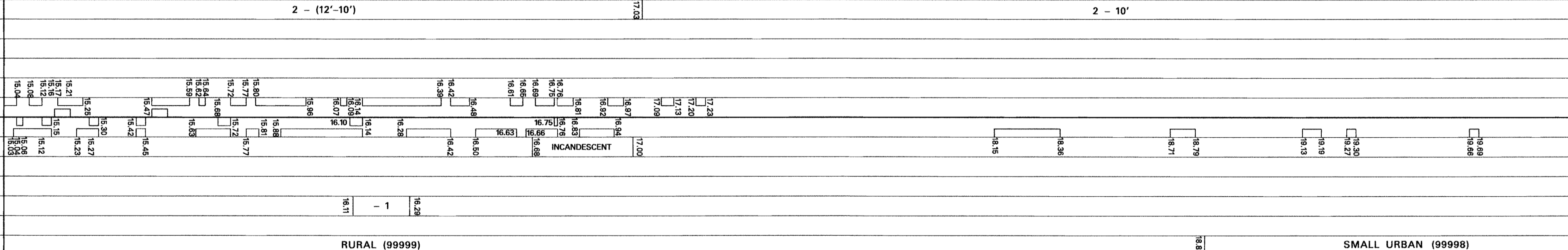

Traffic Stations (Current Year)
HPMS Sections - AADT 2011
HPMS Sections - AADT 2010
HPMS Sections - AADT 2009
DOD Sections
Census Tracts
Functional Classification
National Highway System (NHS)
Previous Projects: Project No., Date and Limits

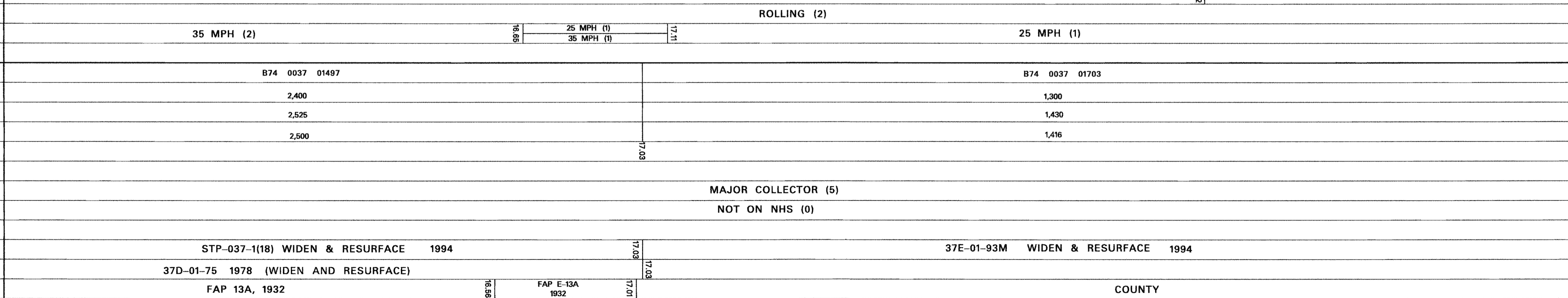

SCALE: (In Miles) 4" = 1 mile

Date Released	Oct 2004	GN
Revised		
Nov. 06	D.B.	
Jan. 10	D.B.	
Feb. 11	D.B.	
Feb. 12	D.B.	
Feb. 13	E.P.J.	

ROAD INVENTORY MAUI RTE 37 HALEAKALA HWY & KULA HWY

STATE OF HAWAII
DEPARTMENT OF TRANSPORTATION
HIGHWAYS DIVISION
PREPARED BY THE
HIGHWAYS PLANNING BRANCH
IN COOPERATION WITH THE
U.S. DEPARTMENT OF TRANSPORTATION
FEDERAL HIGHWAY ADMINISTRATION

Total Route Length: 21.35 miles
a. Survey Length: 21.35 miles
b. Proposed Length: 0.00 miles
c. Other Length: * 0.00 miles

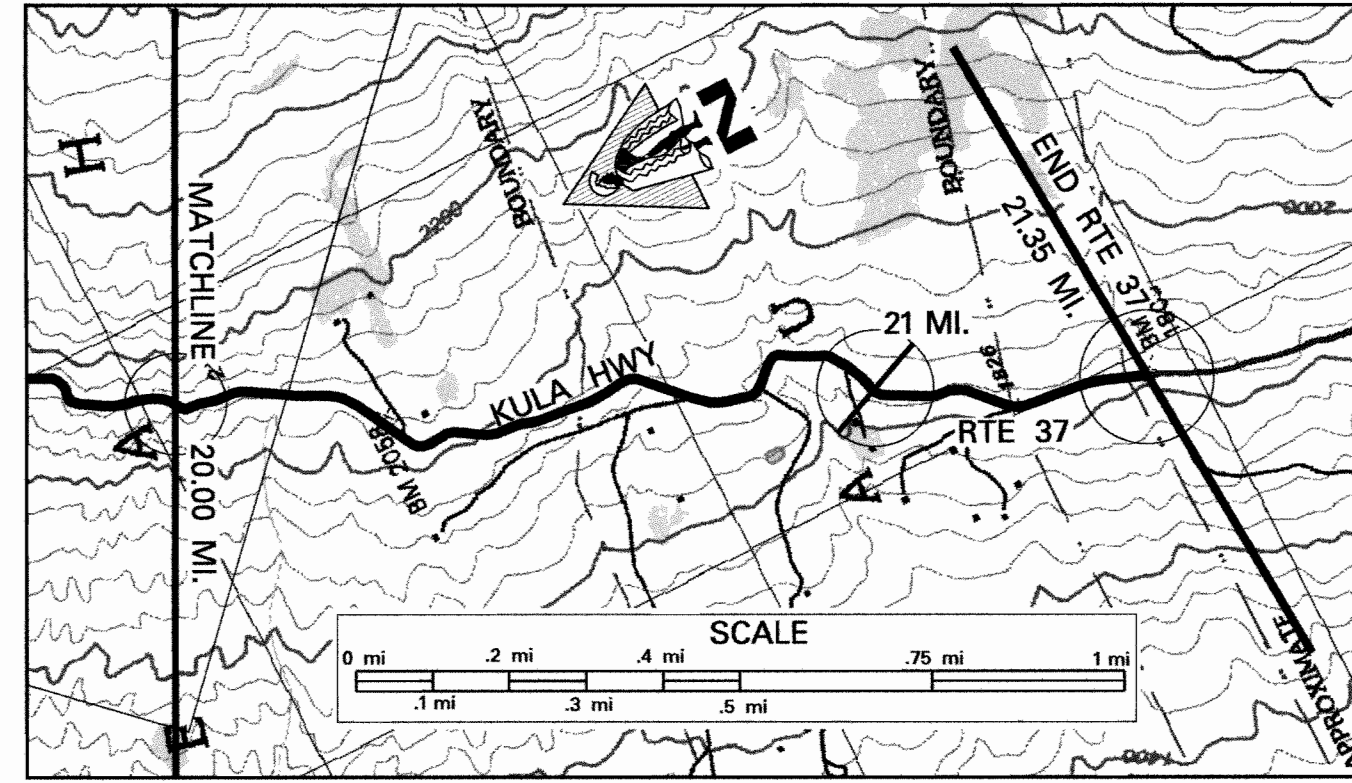

SCALE: (In Miles) 4" = 1 mile

	20	21	22	23	24	25
--	----	----	----	----	----	----

Maintenance Control Sections : Length and Description						
Structure Carrying Road	Bridges (Over 20'): Length, Type, Capacity and Year Constructed					
	Vertical Clearance					
	Horizontal Clearance					
Structure Not Carrying Road	Vertical Clearance					
	Horizontal Clearance					
Right of Way Width (min.-max.) if varies						
Available Right of Way Width (Needs Study)						
60' BRUSH AND PASTURE LAND						
Right of Way Fence: Type - Right and Left						
Control of Access: 1-None, 2-Partial, 3-Full						
Jurisdiction, Transfer Phase No. and Date (C to S or S to C)						
STATE (1325+1987)						
Project No., Type of Construction, and Year Constructed						
37CDE-01-07M, RESURFACE, 2010						
Project No., Type of Construction, and Year Constructed						
37E-01-93M RESURFACE 1994						

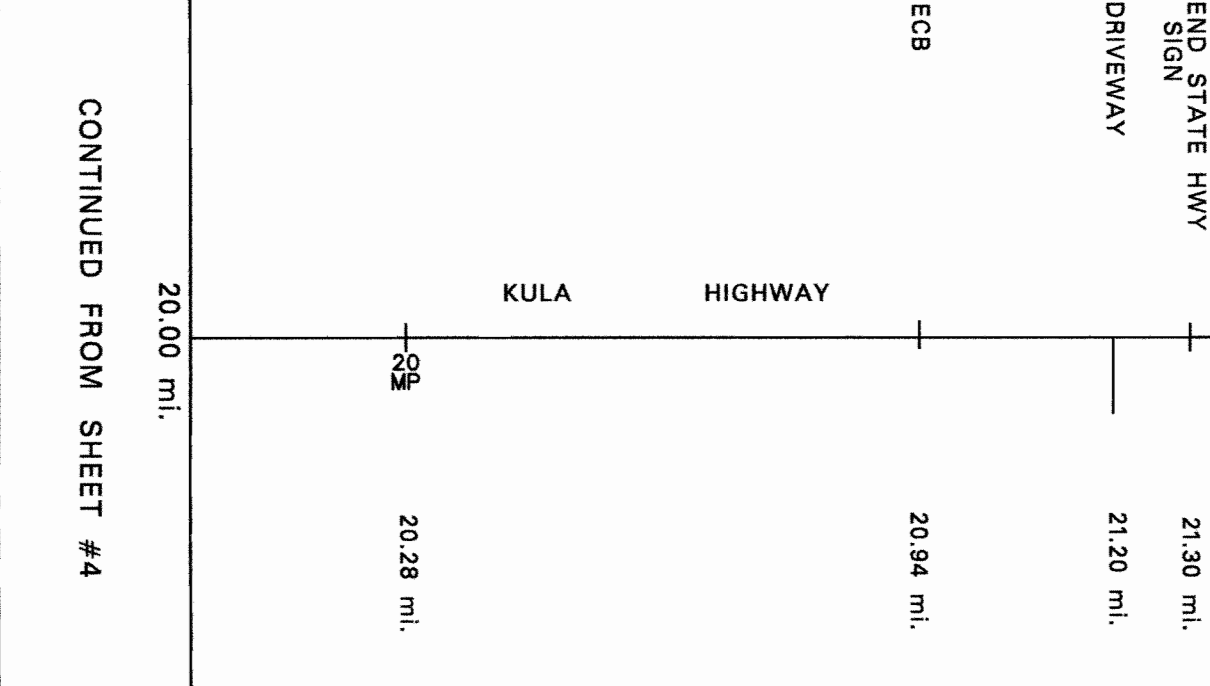
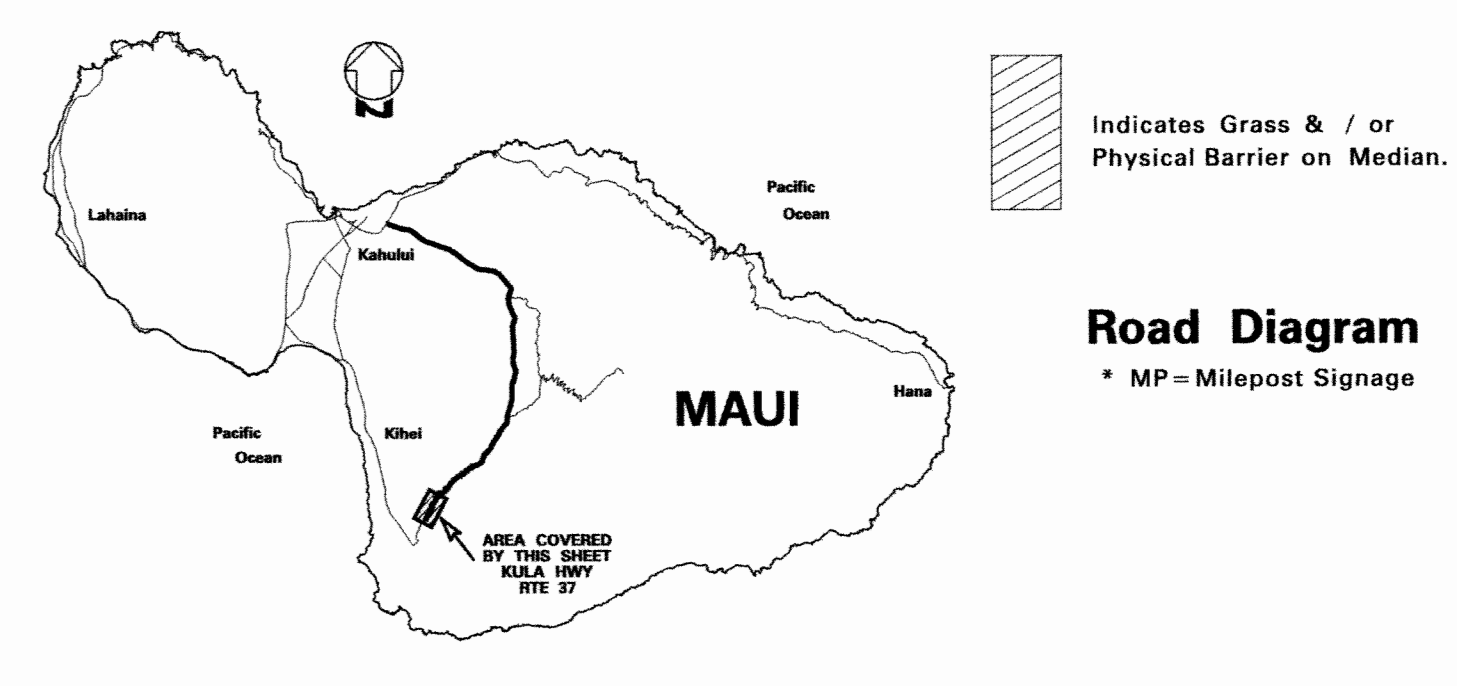

* NOTE: ROUTE LENGTH ADJUSTED TO MATCH
 1/2 MILEPOSTS & 1/2 FEET USED DATABASE.
 END ROUTE 37 ON KULA HIGHWAY
 @ THE CENTERLINE OF MAKENA ROAD
 * 21.38 mi.

SCALE: (In Miles) 4" = 1 mile

Divided Highway						
Undivided	Shoulder: Width and Type	2' AC				
	Pavement: Width and Type	20' AC				
	Shoulder: Width and Type	2' AC				
	Median: Width and Type					
	Shoulder: Width and Type					
	Pavement: Width and Type					
	Shoulder: Width and Type					
Number of Traffic Lanes						
2 - 10'						
Auxiliary Lanes and Parking Lanes: No. of Lanes and Width (Left Side)						
(Right Side)						
Frontage Road: No. of Lanes, and Width (Right and Left)						
Sidewalk: Width and Type (Right and Left)						
Curb and/or Gutter: Type (Right and Left)						
Protective Devices: Type, Location and Number						
Illumination: Type, Location and Number						
Curves: Degree of Curvature (Right and Left)						
Superelevation (Range)						
Grades: % Grade, Positive or Negative						
Vertical Curve: Crest or Sag, Curve Limits						
Area and Development:						
SMALL URBAN (99998)						
Terrain: 1-Flat, 2-Rolling, 3-Mountainous						
ROLLING (2)						
Speed: 1-Design, 2-Posted						
25 MPH (1)						
Intersection Control Devices: Type, Location and Cycle Timing						
Traffic Stations (Current Year)						
874 0037 01703						
HPMS Sections - AADT 2011						
1,300						
HPMS Sections - AADT 2010						
1,430						
HPMS Sections - AADT 2009						
1,416						
DOD Sections						
Census Tracts						
Functional Classification						
MAJOR COLLECTOR (5)						
National Highway System (NHS)						
NOT ON NHS (0)						
Previous Projects: Project No., Date and Limits						
COUNTY						

SCALE: (In Miles) 4" = 1 mile

	20	21	22	23	24	25
--	----	----	----	----	----	----

Date Released	
Oct. 2004	GN
Revised	
Nov., 06	D.B.
April, 09	D.B.
Jan., 10	D.B.
Feb. 11	D.B.
Feb. 12	D.B.
Feb. 13	E.P.F.

ROAD INVENTORY MAUI RTE 310 NORTH KIHAI ROAD

STATE OF HAWAII
DEPARTMENT OF TRANSPORTATION
HIGHWAYS DIVISION

PREPARED BY THE
HIGHWAYS PLANNING BRANCH
IN COOPERATION WITH THE
U.S. DEPARTMENT OF TRANSPORTATION
FEDERAL HIGHWAY ADMINISTRATION

Total Designated Route Length:	3.60	MILES (a+b)
a. Existing Length:	3.60	MILES
b. Proposed Length:	0.00	MILES
Total Travel Way Length:	3.60	MILES (a+b, less c)
a. Existing Length:	3.60	MILES
b. Temporary Length:	0.00	MILES
c. Length used as T.W. for another Route:	0.00	MILES (-)

NEEDS STUDY ROUTE NO. _____ FUNCTIONAL CLASSIFICATION _____

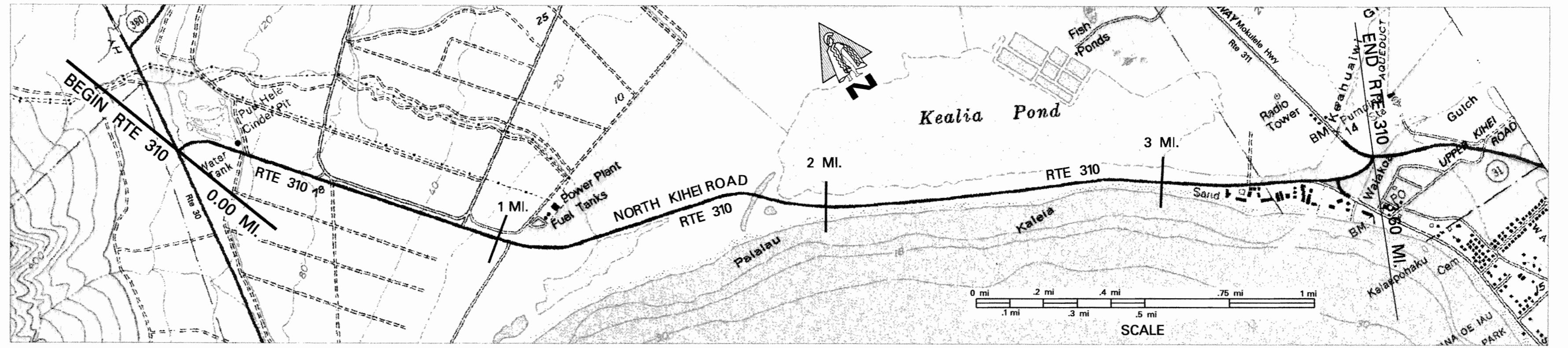

SCALE: (In Miles) 4" = 1 mile

Maintenance Control Sections : Length and Description	0.00 Begin 310A on North Kihai Road @ End Divided Hwy	310A (0.78mi.)	0.86 End 310A, 0.88 Miles from Begin Rte 310	None for County	3.24	3.60
---	---	----------------	--	-----------------	------	------

Structure Carrying Road	Bridges (Over 20'): Length, Type, Capacity and Year Constructed					
	Vertical Clearance					
Structure Over Road	Horizontal Clearance					
	Vertical Clearance					
	Right of Way Width (min.-max.) if varies	200' - 130'	60'	40'	10' - 160'	100' - 340'
	Available Right of Way Width (Needs Study)	1000' Clear, Cane Field 30' from Pavement		Ranch & Pasture (L), Beach (R)	Resort Area	
	Right of Way Fence: Type - Right and Left		Wire	Wire	Wire	
	Control of Access: 1-None, 2-Partial, 3-Full					
	Jurisdiction, Transfer Phase No. and Date (C to S or S to C)	STATE				
	Project No., Type of Construction, and Year Constructed	STP-0310(4), PREVENTIVE MAINTENANCE, 2009				
	Project No., Type of Construction, and Year Constructed	310A-01-00M, (R) 2001				

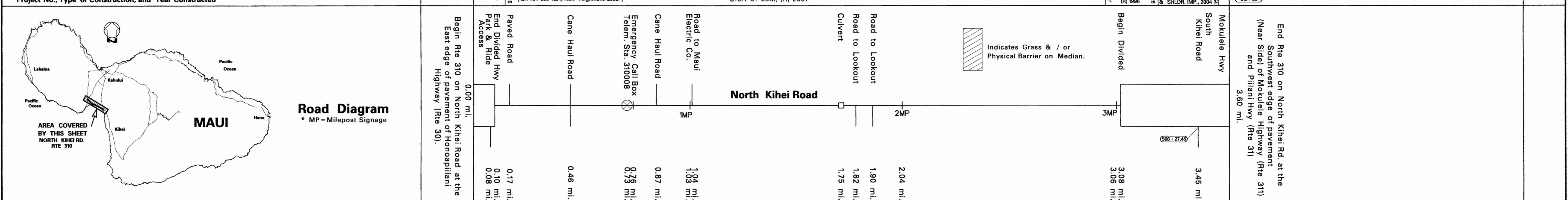

SCALE: (In Miles) 4" = 1 mile

Divided Highway	Shoulder: Width and Type	10' AC	6' AC	10' AC	6' AC	
	Pavement: Width and Type	42' AC	22' AC	12' AC	24' AC	
	Shoulder: Width and Type	10' AC	6' AC	0'	0'	
Undivided Highway	Median: Width and Type	0'-10' Painted AC	0'	0'-12' Painted AC	12'-24' Painted AC	
	Shoulder: Width and Type	0	0	0	0	
	Pavement: Width and Type	16' AC	12' AC	12' AC	24' 12' AC AC	
	Shoulder: Width and Type	10' AC	6' AC	10' AC	6' AC	
	Number of Traffic Lanes	2-11'	2-11'	2-12'	2-12'	
	Auxiliary Lanes and Parking Lanes: No. of Lanes and Width (Left Side)	1-14' (R) TL 2-14' (L) TL		3.46' 2-12' 1-12'	All 12' Turning Lanes	
	(Right Side)	1-12' (R) TL		3.98' 3.94' 1-12' TL	All 12' Turning Lanes	
	Frontage Road: No. of Lanes, and Width (Right and Left)					
	Sidewalk: Width and Type (Right and Left)					
	Curb and/or Gutter: Type (Right and Left)					
	Protective Devices: Type, Location and Number					
	Illumination: Type, Location and Number			4 M.V.	9 HPS	
	Curves: Degree of Curvature (Right and Left)					
	Superelevation (Range)					
	Grades: % Grade, Positive or Negative	-3	0.83	1.28	0	
	Vertical Curve: Crest or Sag, Curve Limits					
	Area and Development:	Small Urban (99998)				
	Terrain: 1-Flat, 2-Rolling, 3-Mountainous	Flat (1)				
	Speed: 1-Design, 2-Posted	45 MPH (2)				
	Intersection Control Devices: Type, Location and Cycle Timing	0.86 3 Phase		3.46 3 Phase	3.86 4 Phase	
	Traffic Stations (Current Year)	(B74 0310 00000)	874 0310 00010	874 0310 00308	874 0310 00334	
	HPMS Sections - AADT 2011	(14,800)	14,700	19,536	14,800	
	HPMS Sections - AADT 2010	(15,453)	15,879	18,475	18,2475	
	HPMS Sections - AADT 2009	(15,300)	18,692	18,292	18,292	
	DOD Sections					
	Census Tracts					
	Functional Classification	Minor Arterial (4)				
	National Highway System (NHS)	Not On NHS (0)				
	Previous Projects: Project No., Date and Limits	310A-01-91M (R) 1992		STP-031-1(B), (R) 1996	[TQF-RF-031-1(6), 1981 (New Construction)]	

SCALE: (In Miles) 4" = 1 mile

Date Released	Revised
July 2002, DB	
Aug. 04 D.B.	
Nov., 06 D.B.	
Mar., 08 D.B.	
Jan., 09 D.B.	
Jan., 10 D.B.	
Feb. 11 D.B.	
Feb. 12 D.B.	
Sept. 12 E.P.J.	

ROAD INVENTORY MAUI RTE 311 PUUNENE AVENUE, MOKULELE HIGHWAY

STATE OF HAWAII
DEPARTMENT OF TRANSPORTATION
HIGHWAYS DIVISION

PREPARED BY THE
HIGHWAYS PLANNING BRANCH
IN COOPERATION WITH THE
U.S. DEPARTMENT OF TRANSPORTATION
FEDERAL HIGHWAY ADMINISTRATION

Total Route Length: 6.41 miles
a. Survey Length: 6.41 miles
b. Proposed Length: 0.00 miles
c. Other Length: * 0.00 miles

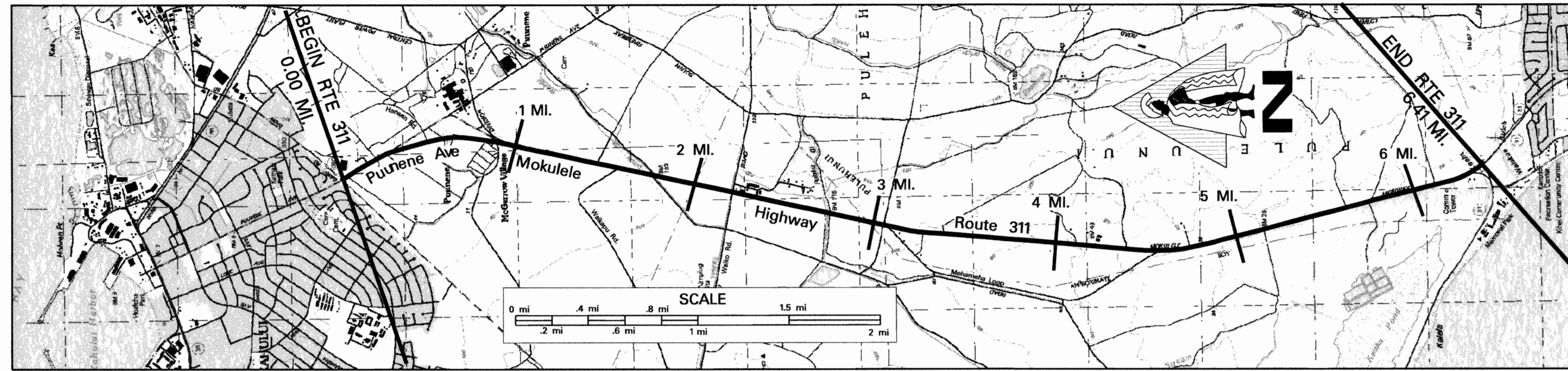

SCALE: (In Miles) 2" = 1 mile

Maintenance Control Sections : Length and Description		0	1	2	3	4	5	6	7	8	9	10
Structure Carrying Road	Bridges (Over 20'): Length, Type, Capacity and Year Constructed											
	Vertical Clearance											
	Horizontal Clearance											
	Right of Way Width (min.-max.) if varies	200' - 218'										
Right of Way	Available Right of Way Width (Needs Study)	240' - 400'										
	Right of Way Fence: Type - Right and Left	Chain Link										
	Control of Access: 1-None, 2-Partial, 3-Full	None										
	Jurisdiction, Transfer Phase No. and Date (C to S or S to C)	State										
Project No., Type of Construction, and Year Constructed		NH-A311(3), Widening, 2003 NH-A311(5), WIDENING, 2005 311A-01-93M, Resurf., 1993 NH-311-(7), WIDENING, 2006 (NH-A311(4), Widen, 2008) (311A-01-93M, Resurf., 1993)										

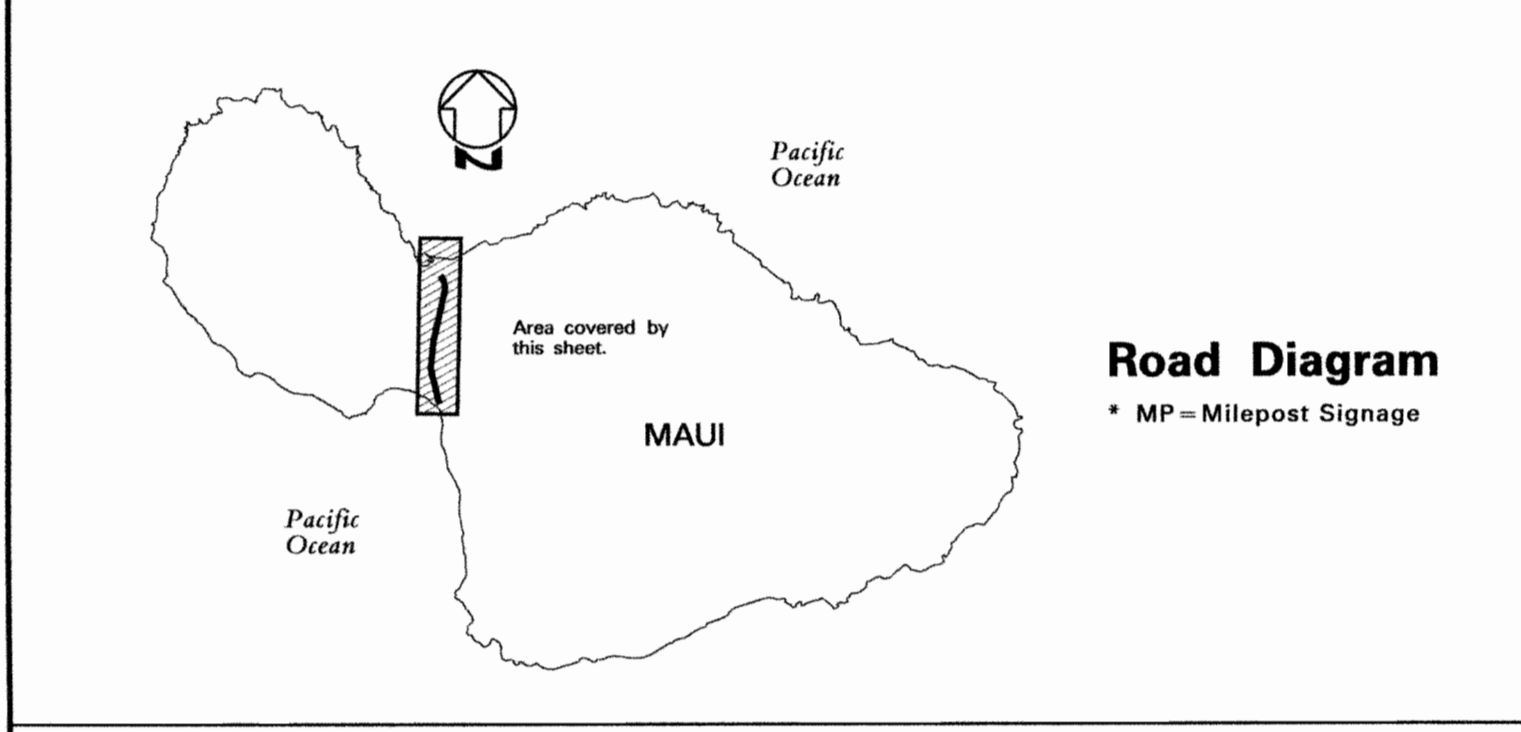

Road Diagram
* MP = Milepost Signage

SCALE: (In Miles) 2" = 1 mile

Divided Highway		0	1	2	3	4	5	6	7	8	9	10
Shoulder: Width and Type	Shoulder: Width and Type											
	Pavement: Width and Type											
	Shoulder: Width and Type											
	Median: Width and Type											
Number of Traffic Lanes	Number of Traffic Lanes	4-12'										
	Auxiliary Lanes and Parking Lanes: No. of Lanes and Width (Left Side)											
	Frontage Road: No. of Lanes, and Width (Right and Left)											
	Sidewalk: Width and Type (Right and Left)											
Curb and/or Gutter: Type (Right and Left)												
Protective Devices: Type, Location and Number												
Illumination: Type, Location and Number		11 HPS 3 MV (6 HPS)										
Curves: Degree of Curvature (Right and Left)												
Superelevation (Range)												
Grades: % Grade, Positive or Negative												
Vertical Curve: Crest or Sag, Curve Limits												
Area and Development:		Small Urban (99998)										
Terrain: 1-Flat, 2-Rolling, 3-Mountainous		Flat (1)										
Speed: 1-Design, 2-Posted		30 MPH (2) 45 MPH (2) (40 MPH (1))										
Intersection Control Devices: Type, Location and Cycle Timing												
Traffic Stations (Current Year)												
HPMS Sections - AADT 2011												
HPMS Sections - AADT 2010												
HPMS Sections - AADT 2009												
DOD Sections												
Census Tracts												
Functional Classification		Principal Arterial (3)										
National Highway System (NHS)		Not on NHS (0) On NHS (1)										
Previous Projects: Project No., Date and Limits		NH-A311(3), Widening, 2003 311A-01-93M, Resurf., 1993 RS-0311(1), Resurf., 1986 311A-01-93M, Resurf., 1993 S05-0900(21), 1984 Safety Imprv.										

SCALE: (In Miles) 2" = 1 mile

Date Released	Revised
Feb 2004, D.B.	
May 04 D.B.	
Sept 04 D.B.	
Feb, 06 D.B.	
Nov, 06 D.B.	
Mar, 09 D.B.	
Jan, 10 D.B.	
Feb, 11 D.B.	
Feb, 12 D.B.	
Sept, 12 E.P.J.	

ROAD INVENTORY MAUI RTE 340 KAHEKILI HIGHWAY

STATE OF HAWAII
DEPARTMENT OF TRANSPORTATION
HIGHWAYS DIVISION
PREPARED BY THE
HIGHWAYS PLANNING BRANCH
IN COOPERATION WITH THE
U.S. DEPARTMENT OF TRANSPORTATION
FEDERAL HIGHWAY ADMINISTRATION

Total Route Length: 4.29 miles
a. Survey Length: 4.29 miles
b. Proposed Length: 0.00 miles
c. Other Length: * 0.00 miles

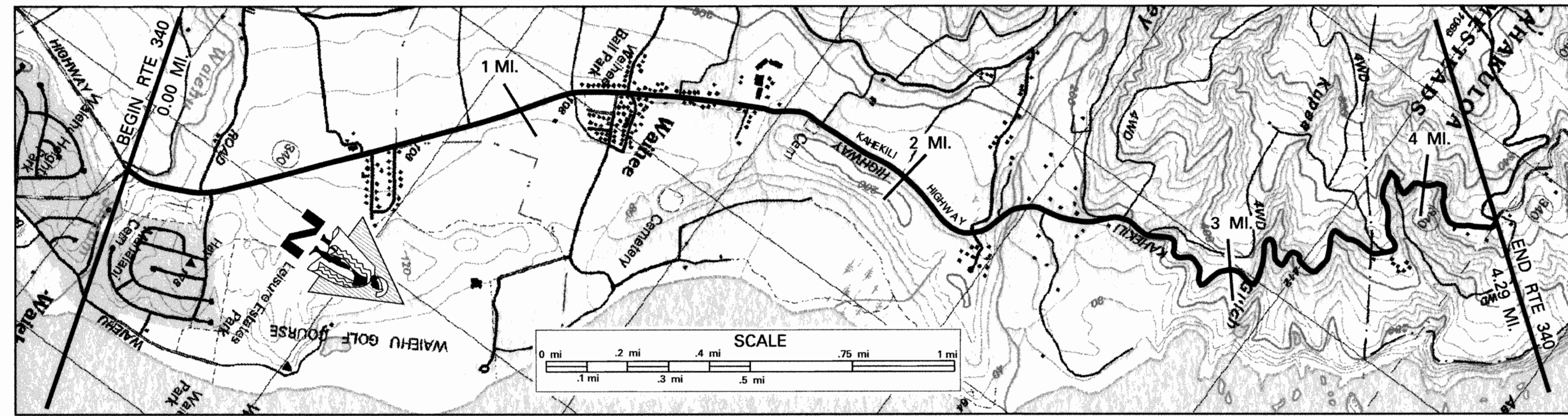

SCALE: (In Miles) 4" = 1 mile

Maintenance Control Sections : Length and Description	0	1	2	3	4	5
Structure Carrying Road	BEGIN 340 C ON KAHEKILI HWY 350' South of centerline intersection with Waiehu Beach Rd. 340 C (2.49 MI) END 340 C 320' North of North end of Waiehu Bridge #2					
Bridges (Over 20'): Length, Type, Capacity and Year Constructed	CULVERT 1967 HS20 34' CULVERT 10' PRESTRESSED BEAM 1967 HS20 245'					
Vertical Clearance	24'					
Horizontal Clearance	70' - 240'					
Right of Way Width (min.-max.) if varies	CLEAR 1000' SUGAR, 25' FROM PAVEMENT RES. AREA HEAVY BRUSH AND TREES / PASTURE BEYOND					
Available Right of Way Width (Needs Study)	CHAINLINK 10' FROM PAVEMENT NONE STATE					
Right of Way Fence: Type - Right and Left	NONE STATE					
Control of Access: 1-None, 2-Partial, 3-Full	NONE STATE					
Jurisdiction, Transfer Phase No. and Date [C to S or S to C]	NONE STATE					
Project No., Type of Construction, and Year Constructed	PERMIT #MA-05-17, IMP, 2006 PERMIT #MA-07-15, IMPRVTS., 2008 340D-01-05M, RESURF., 2007					

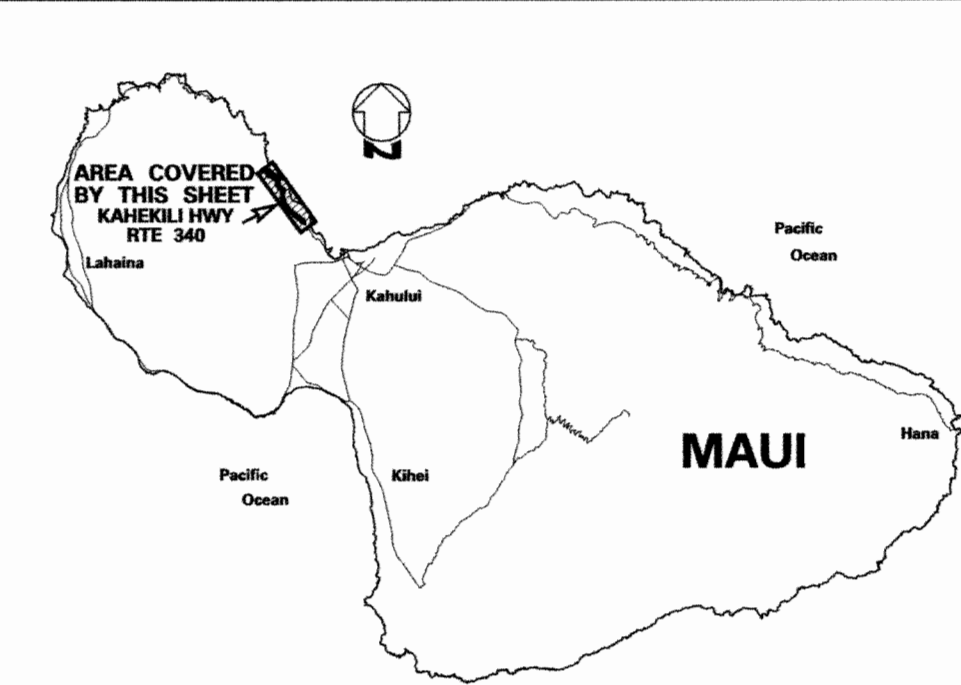

Road Diagram
* MP = Milepost Signage

SCALE: (In Miles) 4" = 1 mile

Divided Highway	0	1	2	3	4	5
Shoulder: Width and Type	6' AC 2'-4' GRS 2'-6' GRS 2'-4' GRS 2' AC 2' AC 2'-4' AC					
Pavement: Width and Type	24' AC 24' AC 24' AC 24' AC 22' AC 2' AC 20' AC					
Shoulder: Width and Type	6' AC 0 0 0 2' AC 2' AC 2'-4' AC					
Median: Width and Type	0 0 0 0 0 0 0					
Shoulder: Width and Type	0 0 0 0 0 0 0					
Pavement: Width and Type	0 0 0 0 0 0 0					
Shoulder: Width and Type	0 0 0 0 0 0 0					
Number of Traffic Lanes	2 - 12' 2 - 11' 2 - 10'					
Auxiliary Lanes and Parking Lanes: No. of Lanes and Width (Left Side)	0 0 0 0 0 0 0					
(Right Side)	0 0 0 0 0 0 0					
Frontage Road: No. of Lanes, and Width (Right and Left)	0 0 0 0 0 0 0					
Sidewalk: Width and Type (Right and Left)	0 0 0 0 0 0 0					
Curb and/or Gutter: Type (Right and Left)	AC CURBS 4'-6" CONC. S.W. 6" CONC. GUTTERS 3" CONC. GUTTERS 3" AC GUTTER					
Protective Devices: Type, Location and Number	METAL RAILS ON CONCRETE POSTS 7 MV 1 MV					
Illumination: Type, Location and Number	0 0 0 0 0 0 0					
Curves: Degree of Curvature (Right and Left)	0 0 0 0 0 0 0					
Superelevation (Range)	0 0 0 0 0 0 0					
Grades: % Grade, Positive or Negative	0 0 0 0 0 0 0					
Vertical Curve: Crest or Sag, Curve Limits	0 0 0 0 0 0 0					
Area and Development:	SMALL URBAN (99998) RURAL (99999) MOUNTAINOUS (3)					
Terrain: 1-Flat, 2-Rolling, 3-Mountainous	ROLLING (2) FLAT (1) ROLLING (2) NOT POSTED					
Speed: 1-Design, 2-Posted	35 MPH (2) 30 MPH (2) 30 MPH (2) 20 MPH (2) 20 MPH (2)					
Intersection Control Devices: Type, Location and Cycle Timing	0 0 0 0 0 0 0					
Traffic Stations (Current Year)	874 0340 00000 874 0340 00124 874 0340 00221 874 0340 00242					
HPMS Sections - AADT 2011	3,800 4,000 1,175 870					
HPMS Sections - AADT 2010	6,666 1,717 1,111 778					
HPMS Sections - AADT 2009	6,600 1,700 1,100 770					
DOD Sections	0 0 0 0 0 0 0					
Census Tracts	0 0 0 0 0 0 0					
Functional Classification	MAJOR COLLECTOR (5)					
National Highway System (NHS)	NOT ON NHS (0)					
Previous Projects: Project No., Date and Limits	S-0341(3) 1966 COUNTY S-0330(2) 1967 COUNTY					

SCALE: (In Miles) 4" = 1 mile

Date Released	Revised
Oct 2004 GN	
Nov. 06 D.B.	
Feb. 08 D.B.	
Dec. 09 D.B.	
Feb. 11 D.B.	
Feb. 12 D.B.	
Sept. 12 E.P.F.	

ROAD INVENTORY MAUI RTE 360 HANA HIGHWAY

STATE OF HAWAII
DEPARTMENT OF TRANSPORTATION
HIGHWAYS DIVISION

PREPARED BY THE
HIGHWAYS PLANNING BRANCH

IN COOPERATION WITH THE
U.S. DEPARTMENT OF TRANSPORTATION
FEDERAL HIGHWAY ADMINISTRATION

Total Route Length: 34.93 miles
a. Survey Length: 34.93 miles
b. Proposed Length: 0.00 miles
c. Other Length: * 0.00 miles

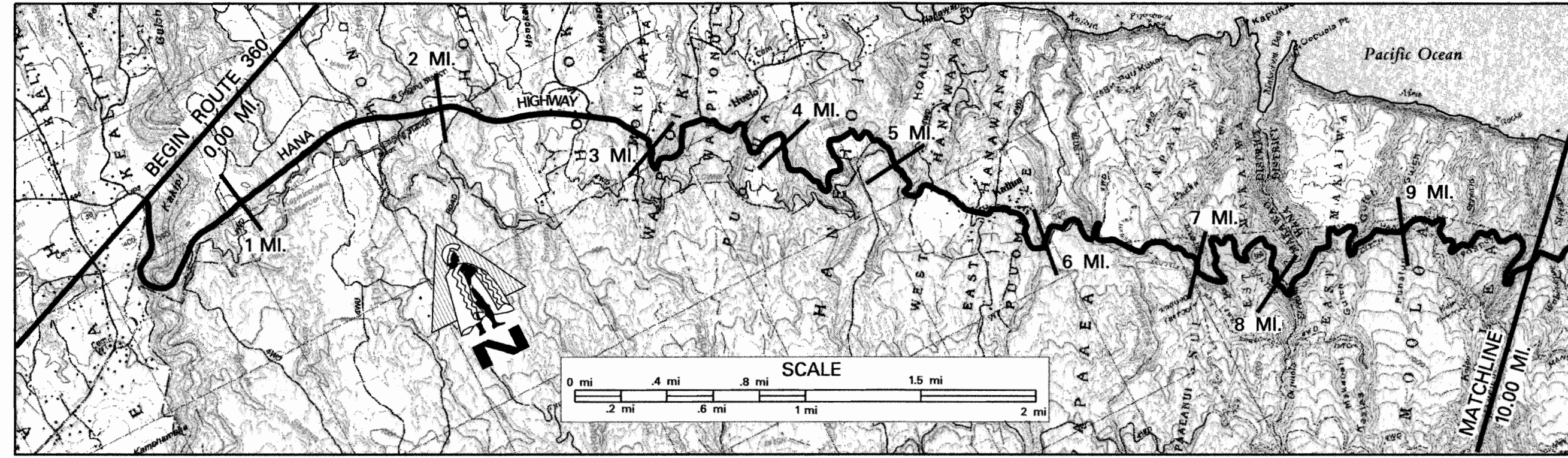

SCALE: (In Miles) 2" = 1 mile		0	1	2	3	4	5	6	7	8	9	10								
Maintenance Control Sections : Length and Description							36 C (5.87 mi.) (Old FAP 36)			360 A (12.20 mi.)										
Structure Carrying Road	Bridges (Over 20') : Length, Type, Capacity and Year Constructed	Culvert 1966 HS 20		Steel Multistringer 1941 HS 20			Tee Beam 1929		Tee Beam 1929 - H15		Tee Beam 1930 - H15		Tee Beam 1926, H15		Slab 1928, H15		Tee Beam 1928, H10		Slab 1911, H15	
	Vertical Clearance	33'		210'			149'		140'		164'		130'		122'		41'			
	Horizontal Clearance	24'		24'			116'		120'		119'		120'		16'		15'		12'	
	Vertical Clearance																			
Structure Over Road	Vertical Clearance																			
	Horizontal Clearance																			
	Right of Way Width (min.-max.) if varies	80'-360'		80'-160'			50'-135'		50'		40'									
	Available Right of Way Width (Needs Study)																			
Right of Way Fence: Type - Right and Left		W/W-Wire on Wood																		
Control of Access: 1-None, 2-Partial, 3-Full		None																		
Jurisdiction, Transfer Phase No. and Date (C to S or S to C)		State																		
Project No., Type of Construction, and Year Constructed		ARR-0360(10), PREV. MAINT., 2010					360A-01-80, 1981			360A-01-82, 1983 (Imprv.) & 360A-01-83M, 1983 (Resurfacing)				360A-01-94M, 1995 (Resurfacing & Improvements)				(360A-02-05M, (R), 2007)		
Project No., Type of Construction, and Year Constructed		STP-0900(39), (R) 1996											3611-00							
<p style="text-align: center;">Road Diagram * MP = Milepost Signage</p>		<p style="text-align: center;">HANA HIGHWAY</p>											<p style="text-align: center;">CONTINUED ON SHEET #2.</p>							
		<p style="text-align: center;">SCALE: (In Miles) 2" = 1 mile</p>																		
Divided Highway	Shoulder: Width and Type	6'-8" AC		2' AC			2'-4" Grs.		0-2' Grass		2'-4" Grs.		0-2' Grass		0-2' Grass					
	Pavement: Width and Type	22' AC		20' AC			20' AC		18' AC											
	Shoulder: Width and Type	4'-6" AC		6'-8" AC			4'-6" AC		0-2' Grass											
	Median Barriers:																			
Number of Traffic Lanes	Number of Traffic Lanes	2-11'		2-10'			2-9'													
	Auxiliary Lanes and Parking Lanes: No. of Lanes and Width (Left Side)																			
	Frontage Road: No. of Lanes, and Width (Right and Left)																			
	Sidewalk: Width and Type (Right and Left)																			
Curb and/or Gutter: Type (Right and Left)		Concrete Barrier											Masonry Wall		Masonry Wall					
Protective Devices: Type, Location and Number		Metal Rails on Metal Posts unless otherwise noted.																		
Illustration: Type, Location and Number		Concrete C&G																		
Curves: Degree of Curvature (Right and Left)		(Small Urban (99999))																		
Superelevation (Range)		+3																		
Grades: % Grade, Positive or Negative		(Mountainous (3))											Rural (99999)							
Vertical Curve: Crest or Sag, Curve Limits		Not Posted											35 MPH (2)		25 MPH (2)		15 MPH (2)		15 MPH (2)	
Area and Development:		Not on NHS (0)											Major Collector (5)		Not on NHS (0)					
Terrain: 1-Flat, 2-Rolling, 3-Mountainous		Not on NHS (0)											Major Collector (5)		Not on NHS (0)					
Speed: 1-Design, 2-Posted		Not on NHS (0)											Major Collector (5)		Not on NHS (0)					
Intersection Control Devices: Type, Location and Cycle Timing		Not on NHS (0)											Major Collector (5)		Not on NHS (0)					
Traffic Stations (Current Year)		Not on NHS (0)											Major Collector (5)		Not on NHS (0)					
HPMS Sections - AADT 2011		Not on NHS (0)											Major Collector (5)		Not on NHS (0)					
HPMS Sections - AADT 2010		Not on NHS (0)											Major Collector (5)		Not on NHS (0)					
HPMS Sections - AADT 2009		Not on NHS (0)											Major Collector (5)		Not on NHS (0)					
DOD Sections		Not on NHS (0)											Major Collector (5)		Not on NHS (0)					
Census Tracts		Not on NHS (0)											Major Collector (5)		Not on NHS (0)					
Functional Classification		Not on NHS (0)											Major Collector (5)		Not on NHS (0)					
National Highway System (NHS)		Not on NHS (0)											Major Collector (5)		Not on NHS (0)					
Previous Projects: Project No., Date and Limits		Not on NHS (0)											Major Collector (5)		Not on NHS (0)					
SCALE: (In Miles) 2" = 1 mile		<p style="text-align: center;">SCALE: (In Miles) 2" = 1 mile</p>																		

Date Released	Revised
Oct. 2003, D.B.	
Sept. 04, D.B.	
Nov. 06, D.B.	
Dec. 09, D.B.	
Feb. 11, D.B.	
Feb. 12, D.B.	
Sept. 12, E.P.J.	

ROAD INVENTORY MAUI RTE 360 HANA HIGHWAY

STATE OF HAWAII
DEPARTMENT OF TRANSPORTATION
HIGHWAYS DIVISION
PREPARED BY THE
HIGHWAYS PLANNING BRANCH
IN COOPERATION WITH THE
U.S. DEPARTMENT OF TRANSPORTATION
FEDERAL HIGHWAY ADMINISTRATION

Total Route Length: 34.93 miles
a. Survey Length: 34.93 miles
b. Proposed Length: 0.00 miles
c. Other Length: * 0.00 miles

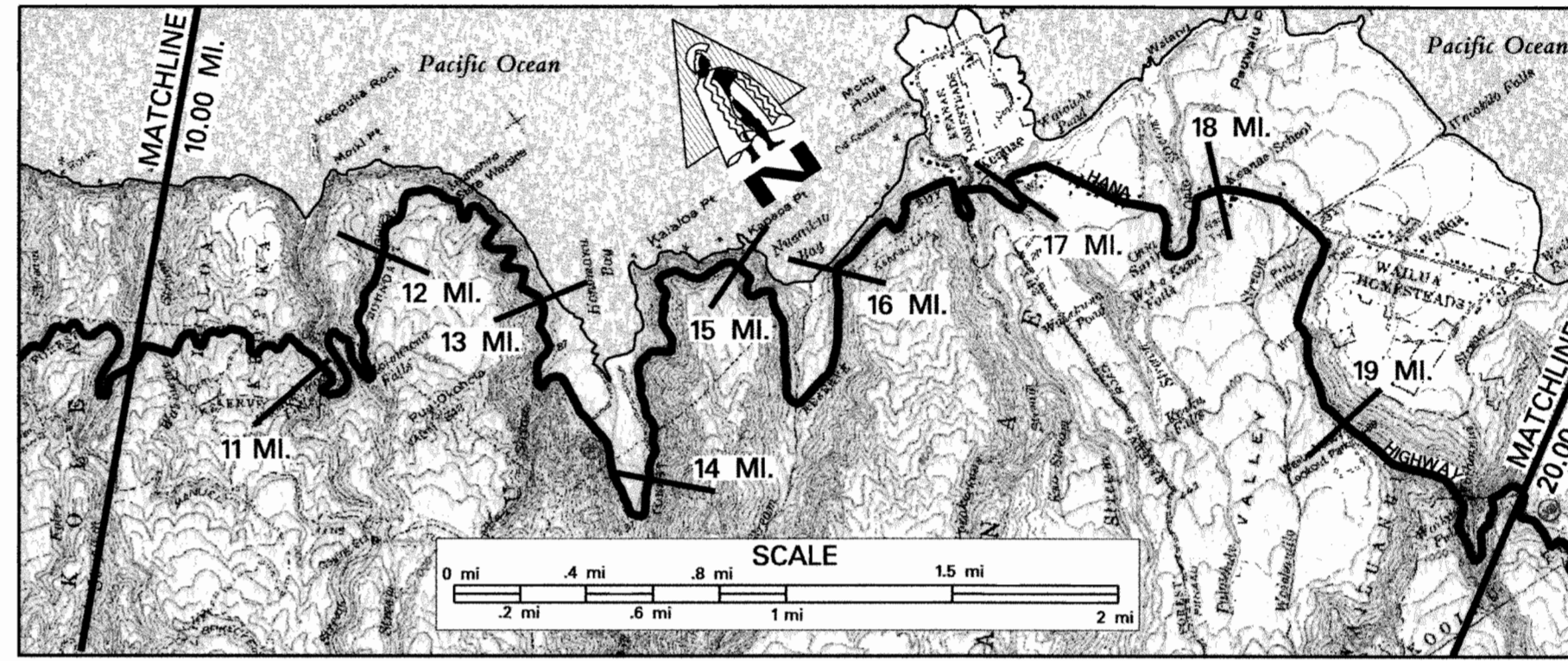

SCALE: (In Miles) 2" = 1 mile

Maintenance Control Sections : Length and Description		10	11	12	13	14	15	16	17	18	19	20	
		360 A (12.20 mi.)											End 360A & Begin 360B on Hana Hwy at the Southeast End of Waioakamo St. Bridge. 360 B (16.57 mi.)
Structure Carrying Road	Bridges (Over 20'): Length, Type, Capacity and Year Constructed												Cantilevered Conc. Deck 2006, HL-93
	Vertical Clearance												100'
	Horizontal Clearance												108'
	Vertical Clearance												108'
Structure Over Road	Vertical Clearance												108'
	Horizontal Clearance												117'
	Vertical Clearance												108'
	Horizontal Clearance												117'
Right of Way Width (min.-max.) if varies		(40'-115')											40'
Available Right of Way Width (Needs Study)													Res. Area
Right of Way Fence: Type - Right and Left		Wire											Heavy Brush & Trees
Control of Access: 1-None, 2-Partial, 3-Full		None											Heavy Brush, Trees & Steep Cliffs
Jurisdiction, Transfer Phase No. and Date (C to S or S to C)		State											(360AB-03-03M Roadway Deck, 2006)
Project No., Type of Construction, and Year Constructed		360A-02-05M, RESURF., 2007											(360AB-01-00M (Repairs & Maintenance) 2002)
Project No., Type of Construction, and Year Constructed		360A-01-94M, 1995 Resurfacing & Improvements											(360AB-01-98M (R) 1999)

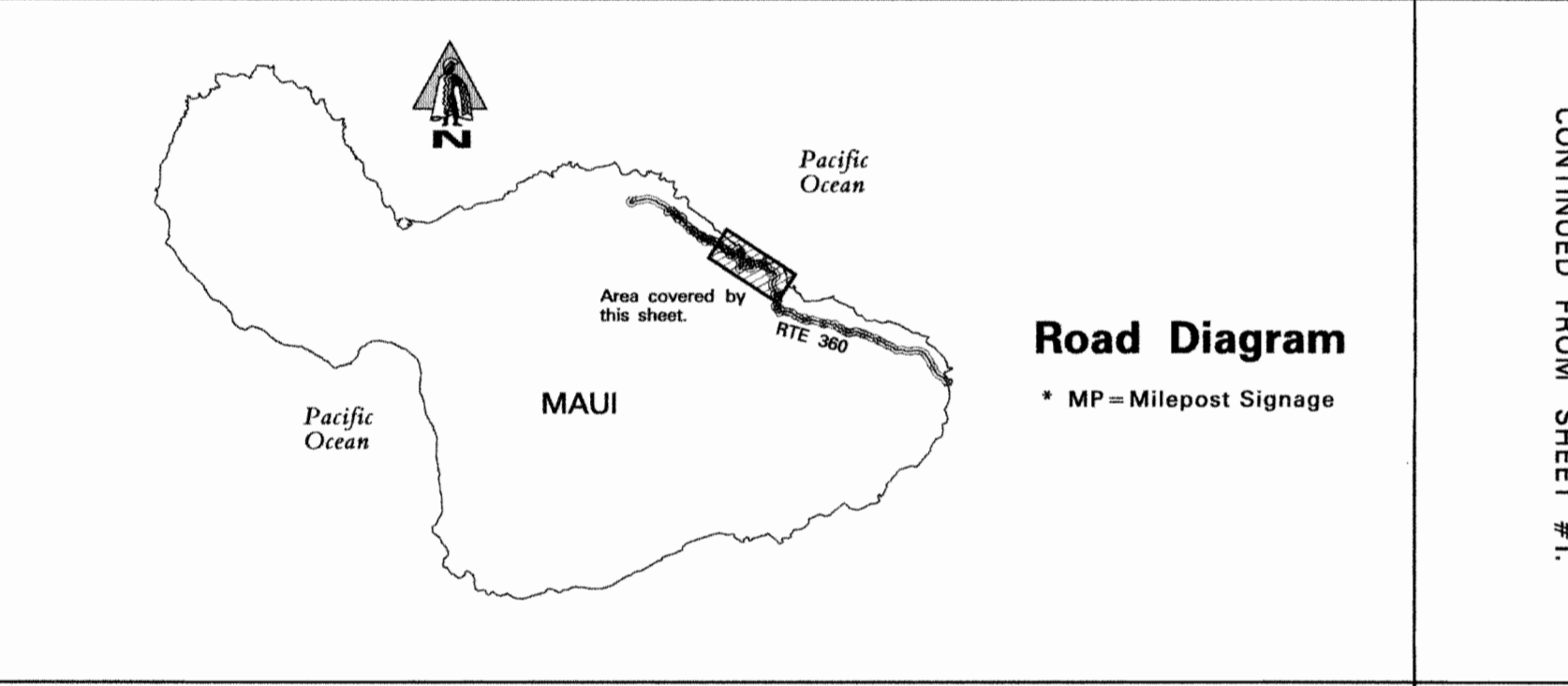

SCALE: (In Miles) 2" = 1 mile

Divided Highway		10	11	12	13	14	15	16	17	18	19	20	
Shoulder: Width and Type	Shoulder: Width and Type												0-2' Grass
	Pavement: Width and Type												18' AC
	Shoulder: Width and Type												0-2' Grass
	Median: Width and Type												0-2' Grass
Median Barriers:	Median Barriers:												0-2' Grass
	Shoulder: Width and Type												18' AC
	Pavement: Width and Type												16'-18' AC
	Shoulder: Width and Type												0-2' Grass
Number of Traffic Lanes		2-9'											2-9'
Auxiliary Lanes and Parking Lanes: No. of Lanes and Width (Left Side)													2-8'
(Right Side)													2-8'
Frontage Road: No. of Lanes, and Width (Right and Left)													2-8'
Sidewalk: Width and Type (Right and Left)													2-8'
Curb and/or Gutter: Type (Right and Left)													2-8'
Protective Devices: Type, Location and Number		Metal Rails on Metal Posts Unless Otherwise Noted.											2-8'
Illumination: Type, Location and Number													2-8'
Curves: Degree of Curvature (Right and Left)													2-8'
Superelevation (Range)													2-8'
Grades: % Grade, Positive or Negative													2-8'
Vertical Curve: Crest or Sag, Curve Limits													2-8'
Area and Development:													2-8'
Terrain: 1-Flat, 2-Rolling, 3-Mountainous		Rural (99999)											2-8'
Speed: 1-Design, 2-Posted		Mountainous (3)											2-8'
Intersection Control Devices: Type, Location and Cycle Timing													2-8'
Traffic Stations (Current Year)		15 MPH (2)											2-8'
HPMS Sections - AADT 2011		15 MPH (2)											2-8'
HPMS Sections - AADT 2010		15 MPH (2)											2-8'
HPMS Sections - AADT 2009		15 MPH (2)											2-8'
DOD Sections		15 MPH (2)											2-8'
Census Tracts		15 MPH (2)											2-8'
Functional Classification		15 MPH (2)											2-8'
National Highway System (NHS)		15 MPH (2)											2-8'
Previous Projects: Project No., Date and Limits		15 MPH (2)											2-8'

SCALE: (In Miles) 2" = 1 mile

Date Released	Revised
Oct 2003, D.B.	
Sept. 04 D.B.	
FEB. 06 D.B.	
Nov. 06 D.B.	
Feb. 08 D.B.	
Dec. 09 D.B.	
Feb. 11 D.B.	
Feb. 12 D.B.	
Sept. 12 E.P.J	

ROAD INVENTORY
MAUI RTE 360
HANA HIGHWAY

STATE OF HAWAII
DEPARTMENT OF TRANSPORTATION
HIGHWAYS DIVISION
PREPARED BY THE
HIGHWAYS PLANNING BRANCH
IN COOPERATION WITH THE
U.S. DEPARTMENT OF TRANSPORTATION
FEDERAL HIGHWAY ADMINISTRATION

Total Route Length: 34.93 miles
a. Survey Length: 34.93 miles
b. Proposed Length: 0.00 miles
c. Other Length: * 0.00 miles

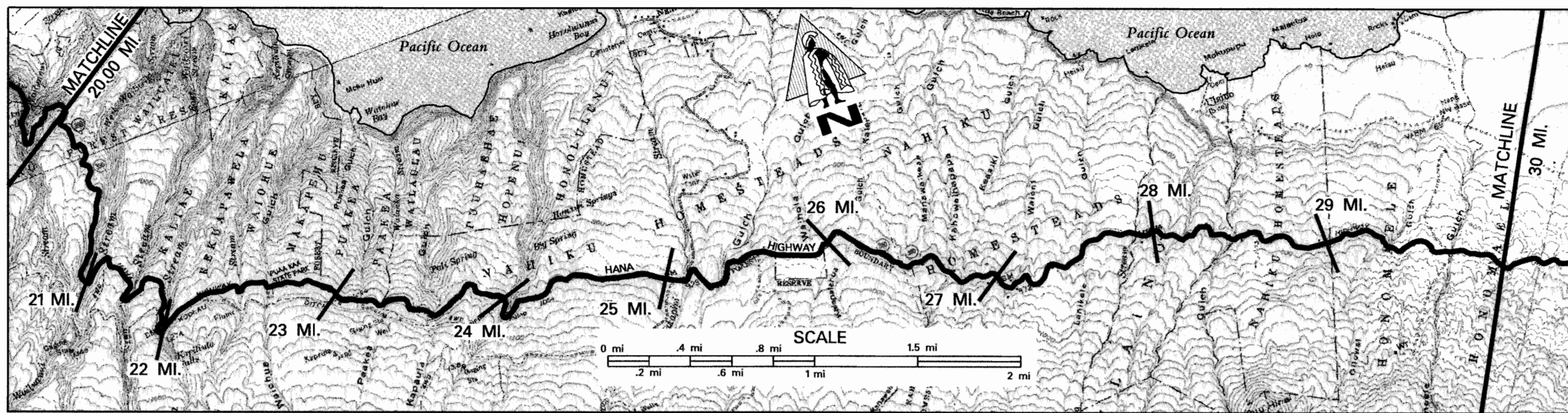

SCALE: (In Miles) 2" = 1 mile

Maintenance Control Sections : Length and Description		20	21	22	23	24	25	26	27	28	29	30
Structure Carrying Road	Bridges (Over 20'): Length, Type, Capacity and Year Constructed											
	Vertical Clearance											
	Horizontal Clearance											
	Vertical Clearance											
Right of Way Width (min.-max.) if varies												
Available Right of Way Width (Needs Study)												
Right of Way Fence: Type - Right and Left												
Control of Access: 1-None, 2-Partial, 3-Full												
Jurisdiction, Transfer Phase No. and Date (C to S or S to C)												
Project No., Type of Construction, and Year Constructed												
Project No., Type of Construction, and Year Constructed												

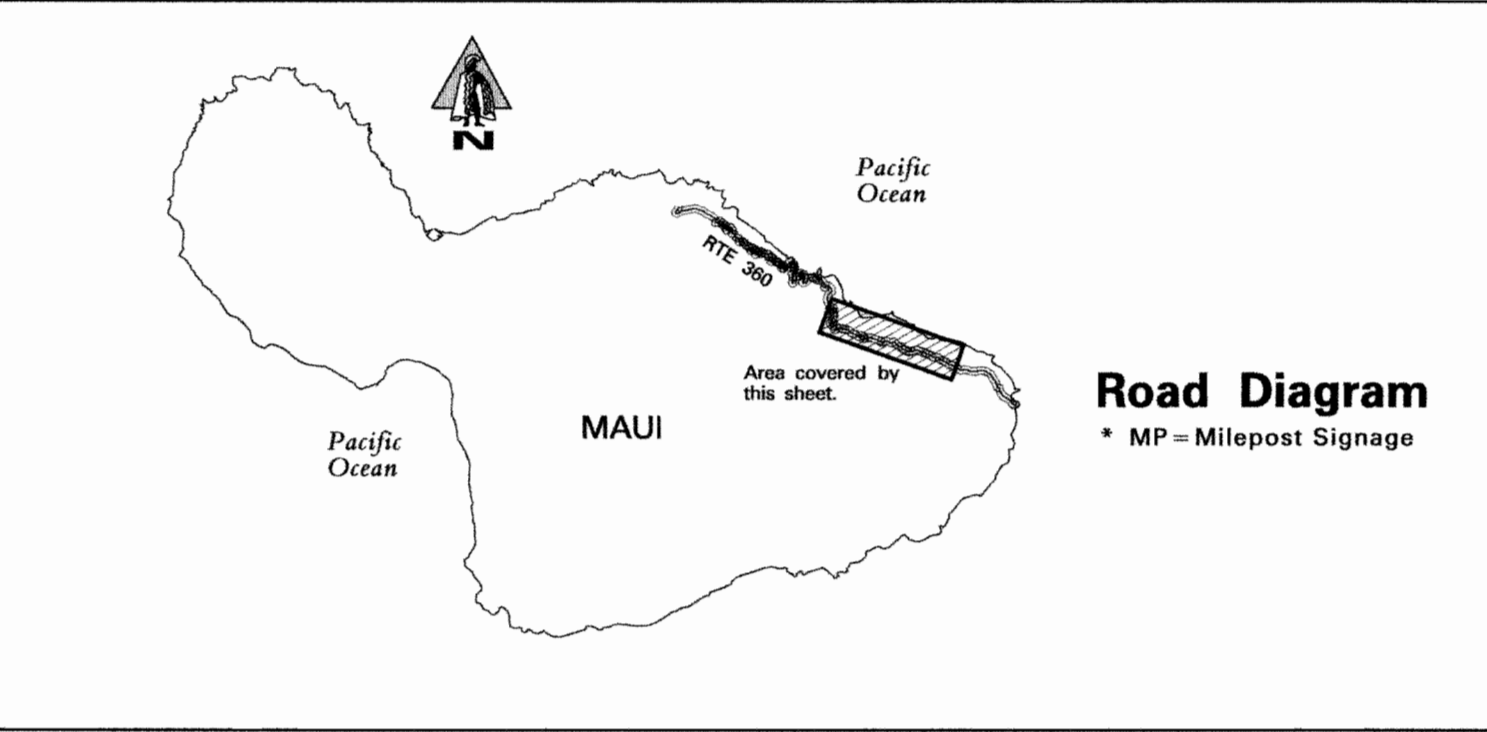

Continued from Sheet #2		20	21	22	23	24	25	26	27	28	29	30
Divided Highway	Shoulder: Width and Type											
	Pavement: Width and Type											
Undivided Highway	Shoulder: Width and Type											
	Pavement: Width and Type											
Number of Traffic Lanes												
Auxiliary Lanes and Parking Lanes: No. of Lanes and Width (Left Side)												
(Right Side)												
Frontage Road: No. of Lanes, and Width (Right and Left)												
Sidewalk: Width and Type (Right and Left)												
Curb and/or Gutter: Type (Right and Left)												
Protective Devices: Type, Location and Number												
Illumination: Type, Location and Number												
Curves: Degree of Curvature (Right and Left)												
Superelevation (Range)												
Grades: % Grade, Positive or Negative												
Vertical Curve: Crest or Sag, Curve Limits												
Area and Development:												
Terrain: 1-Flat, 2-Rolling, 3-Mountainous												
Speed: 1-Design, 2-Posted												
Intersection Control Devices: Type, Location and Cycle Timing												
Traffic Stations (Current Year)												
HPMS Sections - AADT 2011												
HPMS Sections - AADT 2010												
HPMS Sections - AADT 2009												
DOD Sections												
Census Tracts												
Functional Classification												
National Highway System (NHS)												
Previous Projects: Project No., Date and Limits												

SCALE: (In Miles) 2" = 1 mile

SCALE: (In Miles) 2" = 1 mile

Date Released	Revised
Oct 2003, D.B.	Aug. 04 D.B.
	Nov., 06 D.B.
	Dec. 09 D.B.
	Feb. 11 D.B.
	Feb. 12 D.B.
	Sept. 12 E.P.J.

ROAD INVENTORY MAUI RTE 360 HANA HIGHWAY & KEAWA PLACE

STATE OF HAWAII
DEPARTMENT OF TRANSPORTATION
HIGHWAYS DIVISION

PREPARED BY THE
HIGHWAYS PLANNING BRANCH
IN COOPERATION WITH THE
U.S. DEPARTMENT OF TRANSPORTATION
FEDERAL HIGHWAY ADMINISTRATION

Total Route Length: 34.93 miles
a. Survey Length: 34.93 miles
b. Proposed Length: 0.00 miles
c. Other Length: * 0.00 miles

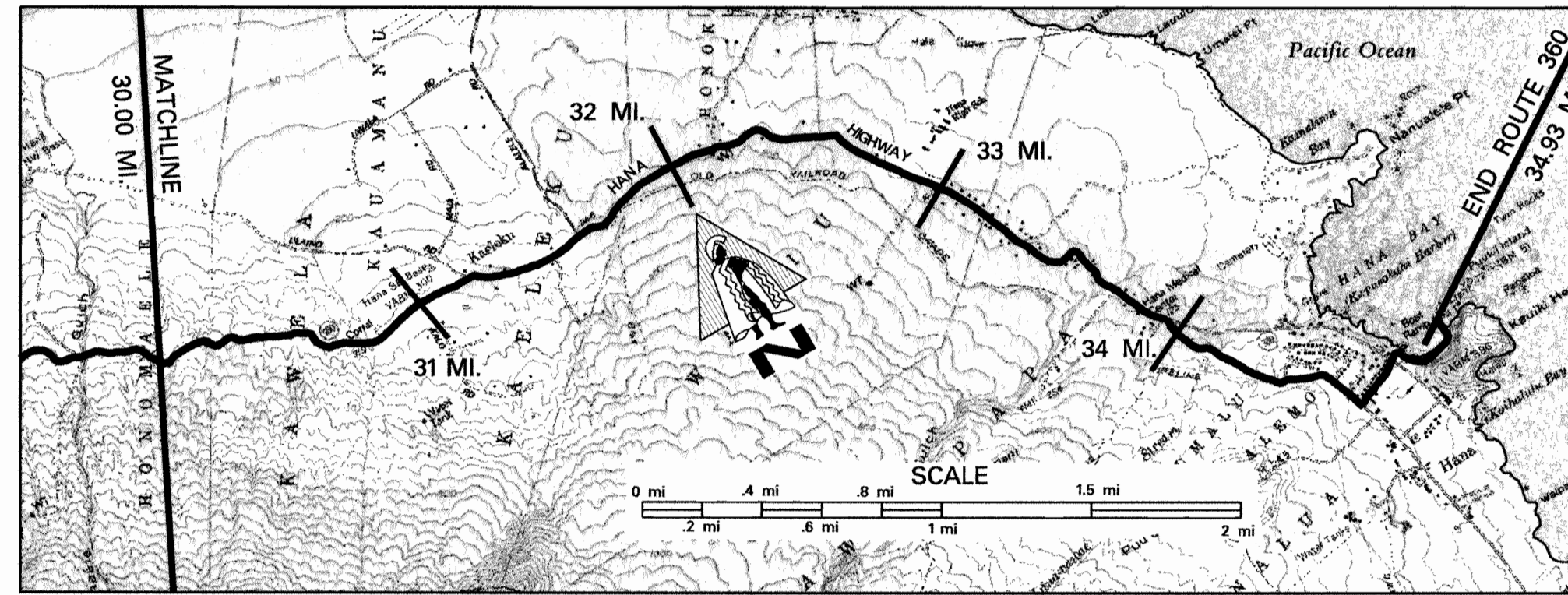

SCALE: (In Miles) 2" = 1 mile

Maintenance Control Sections : Length and Description	30 31 32 33 34 35 36 37 38 39 40	360 B (16.51 mi.)	End 360 B same as End Route.
--	----------------------------------	-------------------	------------------------------

Structure Carrying Road		Tee Beam - H20 1947	
Vertical Clearance		73'	
Horizontal Clearance		126'	
Right of Way Width (min.-max.) if varies		40'	
Available Right of Way Width (Needs Study)			
Right of Way Fence: Type - Right and Left	W/W - Wire on Wood		
Control of Access: 1-None, 2-Partial, 3-Full		None	
Jurisdiction, Transfer Phase No. and Date (C to S or S to C)		State	
Project No., Type of Construction, and Year Constructed		360B-02-06M, Resurfacing, 2010	
Project No., Type of Construction, and Year Constructed			

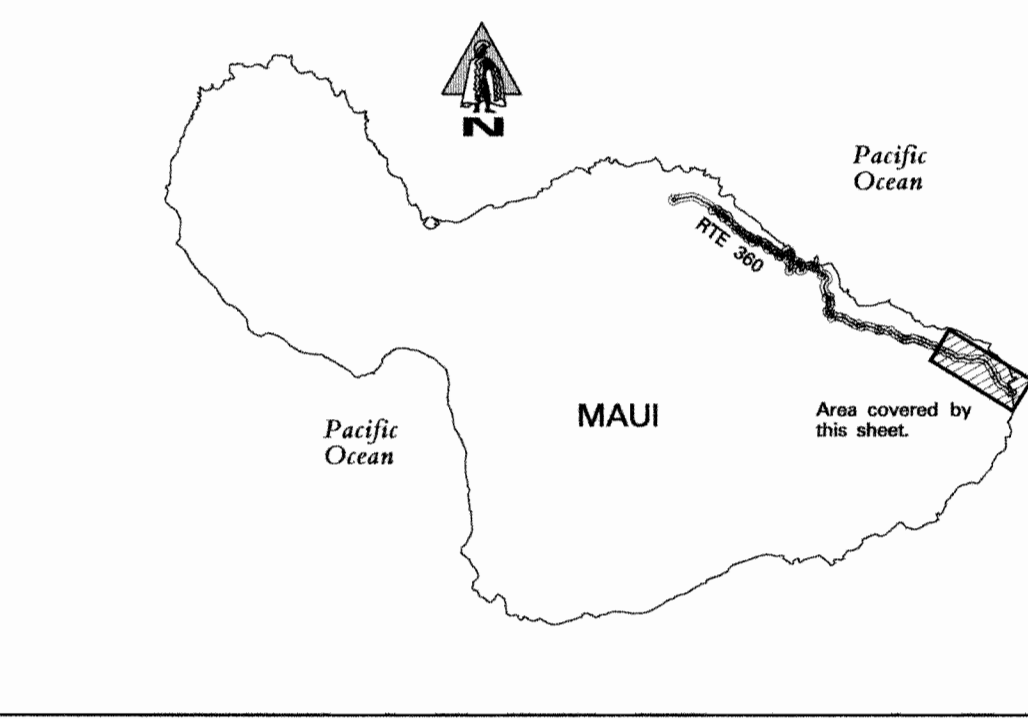

Road Diagram
* MP = Milepost Signage

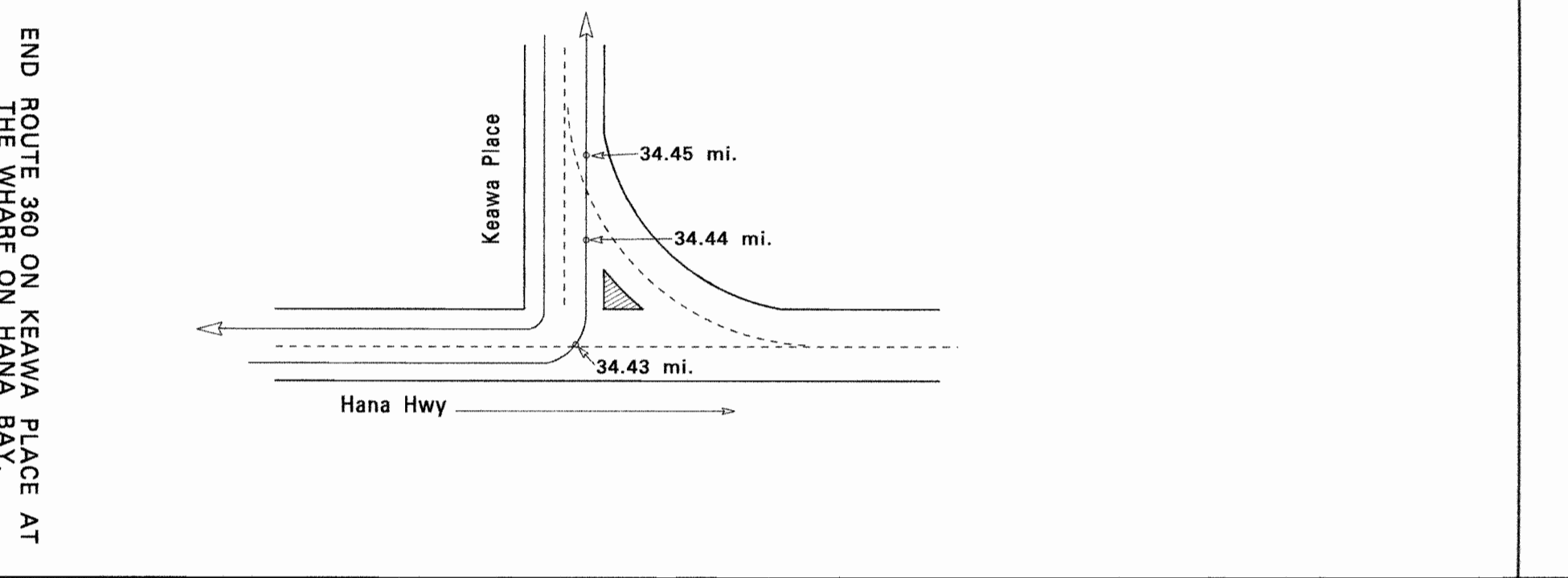
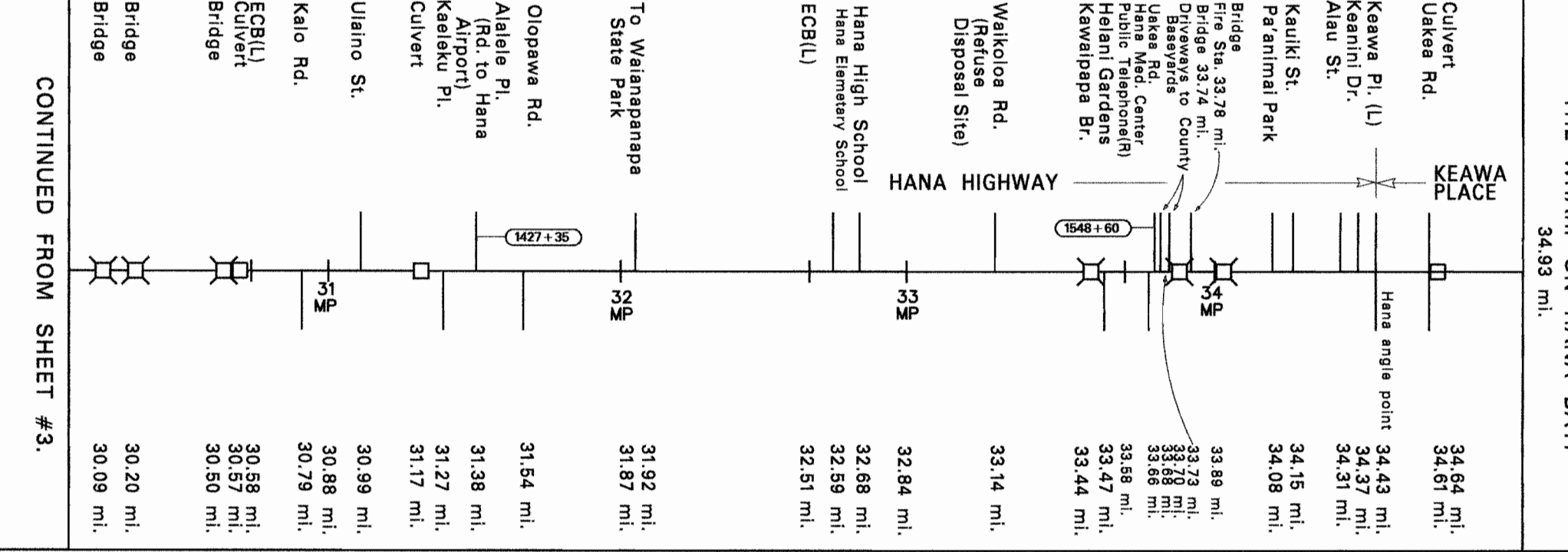

SCALE: (In Miles) 2" = 1 mile

Shoulder: Width and Type		0-2' Grs. 2'-4" Grs.	
Pavement: Width and Type		18' AC	
Shoulder: Width and Type		0-2' Grs. 2'-4" Grs.	
Median: Width and Type		4' AC	
Median Barriers:			
Shoulder: Width and Type			
Pavement: Width and Type			
Shoulder: Width and Type			
Number of Traffic Lanes		2-9'	
Auxiliary Lanes and Parking Lanes: No. of Lanes and Width (Left Side)			
(Right Side)		2-10'	
Frontage Road: No. of Lanes, and Width (Right and Left)			
Sidewalk: Width and Type (Right and Left)			
Curb and/or Gutter: Type (Right and Left)			
Protective Devices: Type, Location and Number			
Metal Rails on Metal Posts unless otherwise noted.			
Illumination: Type, Location and Number			
Curves: Degree of Curvature (Right and Left)			
Superelevation (Range)			
Grades: % Grade, Positive or Negative			
Vertical Curve: Crest or Sag, Curve Limits			
Area and Development:			
Terrain: 1-Flat, 2-Rolling, 3-Mountainous		(Mountainous (3)) Rural (99999)	
Speed: 1-Design, 2-Posted			
Intersection Control Devices: Type, Location and Cycle Timing			
Traffic Stations (Current Year)			
HPMS Sections - AADT 2011			
HPMS Sections - AADT 2010			
HPMS Sections - AADT 2009			
DOD Sections			
Census Tracts			
Functional Classification		Major Collector (5)	
National Highway System (NHS)		Not on NHS (0)	
Previous Projects: Project No., Date and Limits			

SCALE: (In Miles) 2" = 1 mile

Date Released	
Oct 2003, D.B.	
Revised	
Aug. 04 D.B.	
FEB. 06 D.B.	
Nov. 06 D.B.	
Dec. 09 D.B.	
Feb. 11 D.B.	
Feb. 12 D.B.	
Sept. 12 E.P.J.	

ROAD INVENTORY MAUI RTE 377 KEKAULIKE AVE & HALEAKALA HWY

STATE OF HAWAII
DEPARTMENT OF TRANSPORTATION
HIGHWAYS DIVISION
PREPARED BY THE
HIGHWAYS PLANNING BRANCH
IN COOPERATION WITH THE
U.S. DEPARTMENT OF TRANSPORTATION
FEDERAL HIGHWAY ADMINISTRATION

Total Route Length: 9.17 miles
a. Survey Length: 9.17 miles
b. Proposed Length: 0.00 miles
c. Other Length: * 0.00 miles

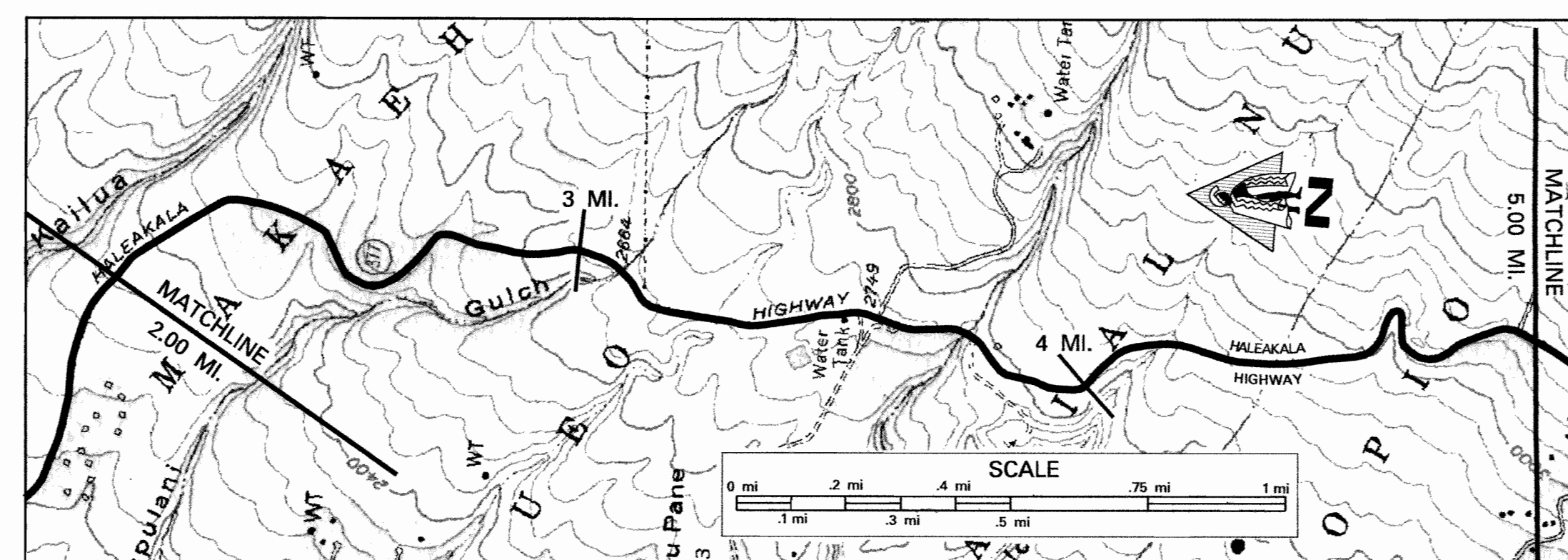
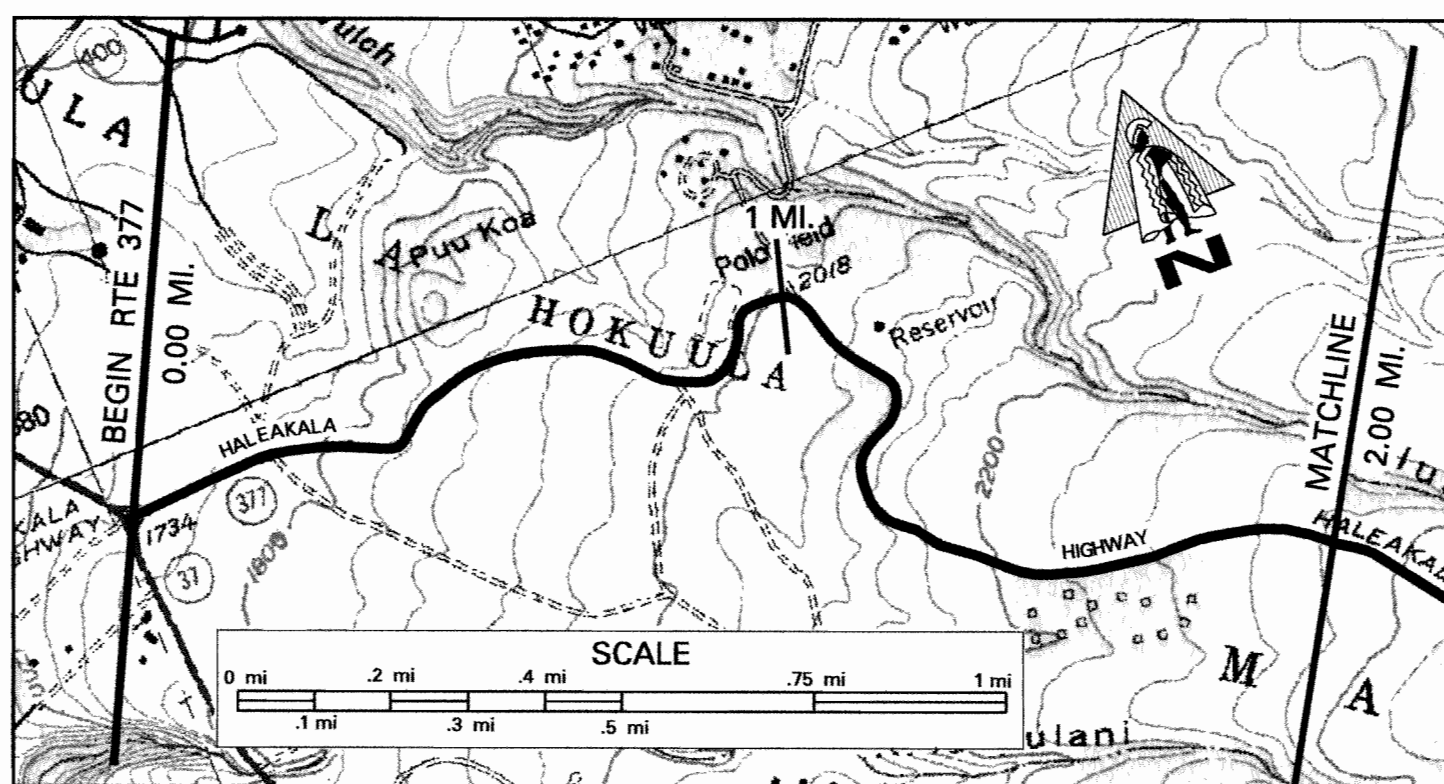

SCALE: (In Miles) 4" = 1 mile

Maintenance Control Sections : Length and Description	0.00 Begin 377A on Haleakala Hwy, 150' East of the centerline intersection with Kula Hwy and Haleakala Hwy. 377A (9.13 MI)
--	--

Structure Carrying Road	Bridges (Over 20'): Length, Type, Capacity and Year Constructed	TEE BEAM 1934 H15 1 150'
Structure Over Road	Vertical Clearance	
	Horizontal Clearance	
	Vertical Clearance	24'
	Horizontal Clearance	

Right of Way Width (min.-max.) if varies	60'
Available Right of Way Width (Needs Study)	PASTURE ON MOUNTAINOUS TERRAIN WITH CUT SLOPES
Right of Way Fence: Type - Right and Left	20' - 40' FROM PAVEMENT 10' - 30' FROM PAVEMENT
Control of Access: 1-None, 2-Partial, 3-Full	NONE
Jurisdiction, Transfer Phase No. and Date (C to S or S to C)	STATE
Project No., Type of Construction, and Year Constructed	STP-0377(005), 2012, PREVENTIVE MAINTENANCE
Project No., Type of Construction, and Year Constructed	STP-0377(3), 1995 GUARDRAIL AND SHOULDER IMPROVEMENT

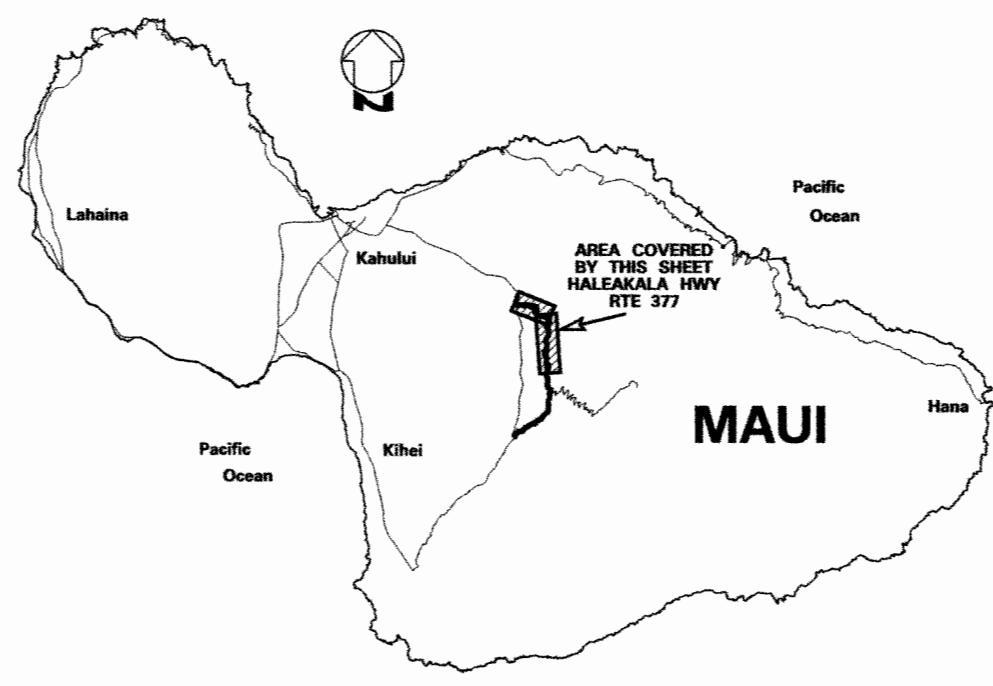

Road Diagram
* MP = Milepost Signage

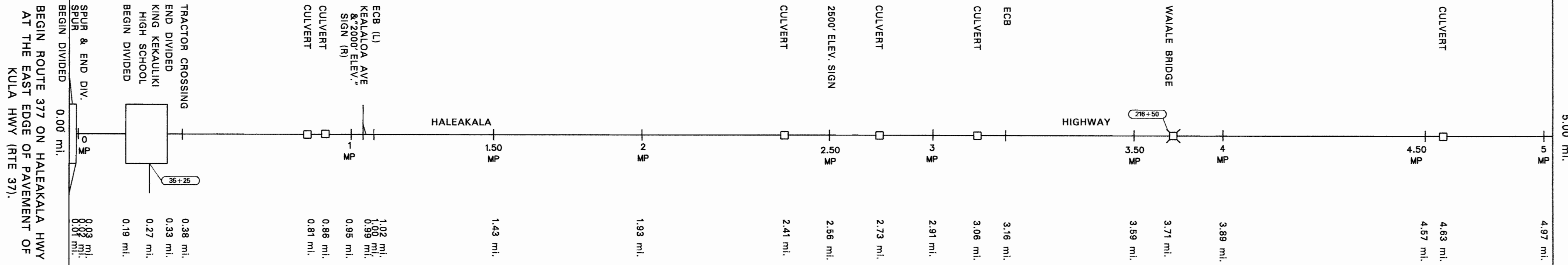

SCALE: (In Miles) 4" = 1 mile

Divided Highway	Undivided	Shoulder: Width and Type	(11' AC) 22' AC 11' AC 22' AC	1.08	4' AC	18' AC	4' AC
	Divided	Median: Width and Type	(0) 4' AC 0	0.02	0.33	0.11	0.11
Shoulder: Width and Type		(0) 0	0.02	0.19	0.11	0.11	0.11
Pavement: Width and Type		(11' AC) 11' AC	0.02	0.19	0.11	0.11	0.11
Shoulder: Width and Type		(4' AC) 4' AC	0.02	0.19	0.11	0.11	0.11
Number of Traffic Lanes		2 - 11'		1.08	2 - 9'		
Auxiliary Lanes and Parking Lanes: No. of Lanes and Width (Left Side)		2 - 11' T.L.		1.08	2 - 9' T.L.		
Frontage Road: No. of Lanes, and Width (Right and Left)		2 - 11' T.L.		1.08	2 - 9' T.L.		
Sidewalk: Width and Type (Right and Left)		0.00		0.00	0.00		
Curb and/or Gutter: Type (Right and Left)		0.00		0.00	0.00		
Protective Devices: Type, Location and Number		ALL GUARDRAILS METAL ON METAL, EXCEPT WHEN NOTED		1.08	ALL GUARDRAILS METAL ON METAL, EXCEPT WHEN NOTED		
Illumination: Type, Location and Number		0.00		0.00	0.00		
Curves: Degree of Curvature (Right and Left)		0.00		0.00	0.00		
Superelevation (Range)		-7		1.51	-7		2.18
Grades: % Grade, Positive or Negative		-7		1.51	-7		2.18
Vertical Curve: Crest or Sag, Curve Limits		SMALL URBAN (99999)		1.00	RURAL (99999)		
Area and Development:		SMALL URBAN (99999)		1.00	RURAL (99999)		
Terrain: 1-Flat, 2-Rolling, 3-Mountainous		SMALL URBAN (99999)		1.00	ROLLING (2)		
Speed: 1-Design, 2-Posted		30 MPH (2)		1.00	30 MPH (2)		
Intersection Control Devices: Type, Location and Cycle Timing		30 MPH (2)		1.00	30 MPH (2)		
Traffic Stations (Current Year)		B74 0377 00000		1.00	B74 0377 00100		
HPMS Sections - AADT 2011		4,100		1.00	2,300		
HPMS Sections - AADT 2010		4,545		1.00	2,222		
HPMS Sections - AADT 2009		4,500		1.00	2,200		
DOD Sections		0.00		0.00	0.00		
Census Tracts		0.00		0.00	0.00		
Functional Classification		MAJOR COLLECTOR (5)		1.00	NOT ON NHS (0)		
National Highway System (NHS)		NOT ON NHS (0)		1.00	NOT ON NHS (0)		
Previous Projects: Project No., Date and Limits		377A-02-81M 1981 RESURFACE		1.07	STP-0377(4), 1994 RESURFACE		
		FAP 5B 1933		0.88	377A-01-83M 1983 RESURFACE		4.03
					JOB #5569 1952 RESURFACE		
					FAP-5B 1929, 1933		
					377A-01-85M 1985 RESURFACE		

SCALE: (In Miles) 4" = 1 mile

CONTINUES ON SHEET # 2

Date Released	
Oct 2004	GN
Revised	
Nov. 06	D.B.
Dec. 09	D.B.
Feb. 11	D.B.
Feb. 12	D.B.
Sept. 12	E.P.J.

ROAD INVENTORY MAUI RTE 377 KEKAULIKE AVE & HALEAKALA HWY

STATE OF HAWAII
DEPARTMENT OF TRANSPORTATION
HIGHWAYS DIVISION
PREPARED BY THE
HIGHWAYS PLANNING BRANCH
IN COOPERATION WITH THE
U.S. DEPARTMENT OF TRANSPORTATION
FEDERAL HIGHWAY ADMINISTRATION

Total Route Length: 9.17 miles
a. Survey Length: 9.17 miles
b. Proposed Length: 0.00 miles
c. Other Length: * 0.00 miles

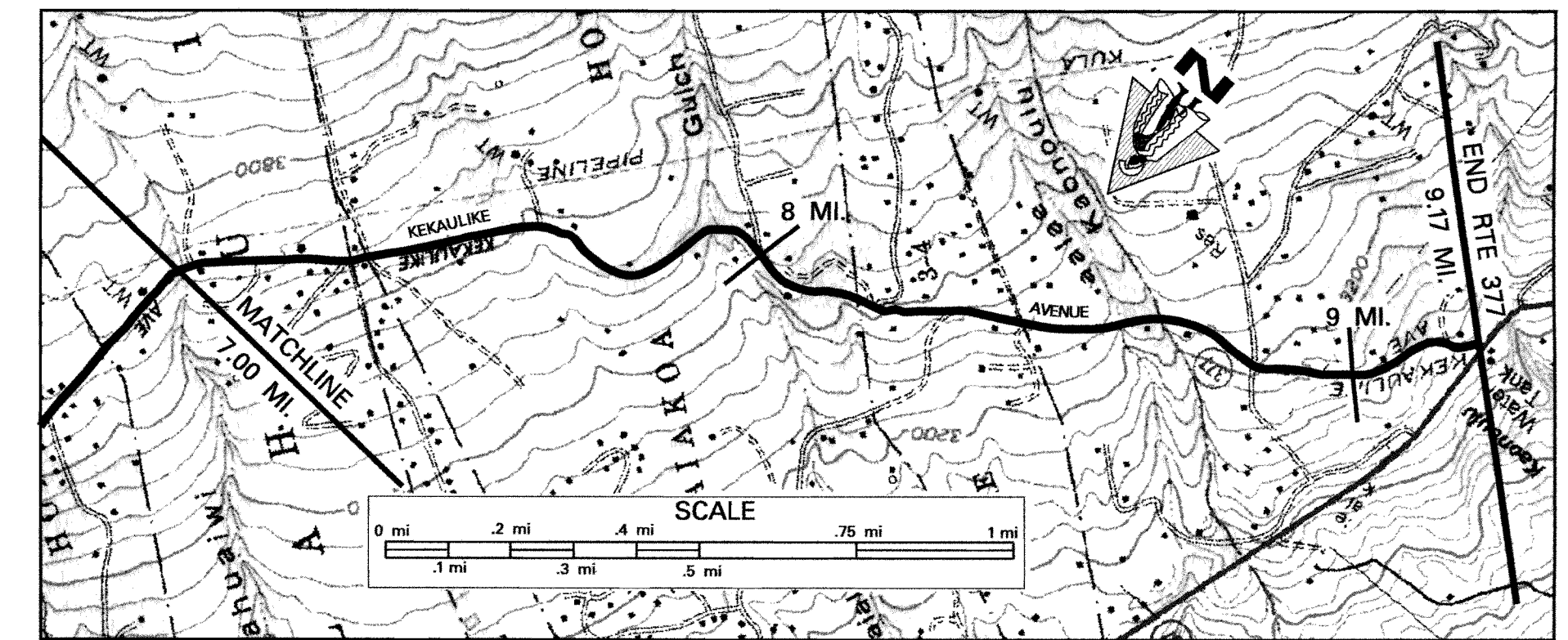
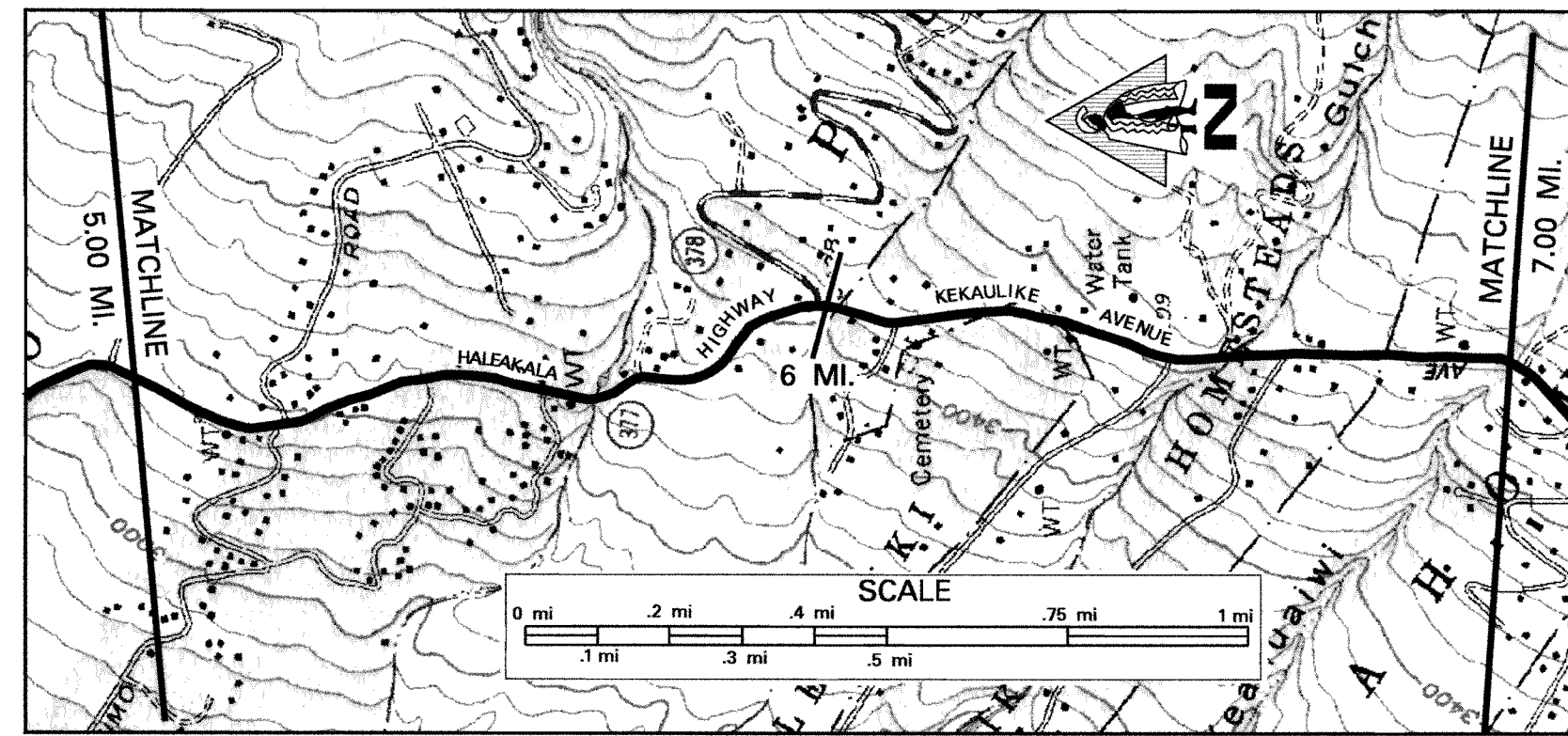

SCALE: (In Miles) 4" = 1 mile

	5	6	7	8	9	10
Maintenance Control Sections : Length and Description	377A (9.13 MI) End 377A on Kekaulike Hwy, 50' East of centerline intersection with Kula Hwy.					
Structure Carrying Road	Bridges (Over 20'): Length, Type, Capacity and Year Constructed TEE BEAM 1934 HHS 110' TEE BEAM 1933 HHS 25' TEE BEAM 1933 HHS 36' TEE BEAM 1933 HHS 150' TEE BEAM 1933 HHS 30'					
Structure under Road	Vertical Clearance Horizontal Clearance 22' 22' 24' 22' 22'					
Right of Way Width (min.-max.) if varies	60'					
Available Right of Way Width (Needs Study)	PASTURE AND RANCH AREA					
Right of Way Fence: Type - Right and Left	ALL WIRE ON WOOD FENCE 10'-20' FROM PVMT UNLESS NOTED					
Control of Access: 1-None, 2-Partial, 3-Full	NONE					
Jurisdiction, Transfer Phase No. and Date (C to S or S to C)	STATE					
Project No., Type of Construction, and Year Constructed	STP-0377(005), 2012, PREVENTIVE MAINTENANCE 377B-01-96M 1998 RESURFACE					
Project No., Type of Construction, and Year Constructed	STP-0377(3) 1995 GUARDRAILS & SHLDR IMPR. RS-0377(2) 1987 IMPROVEMENTS					

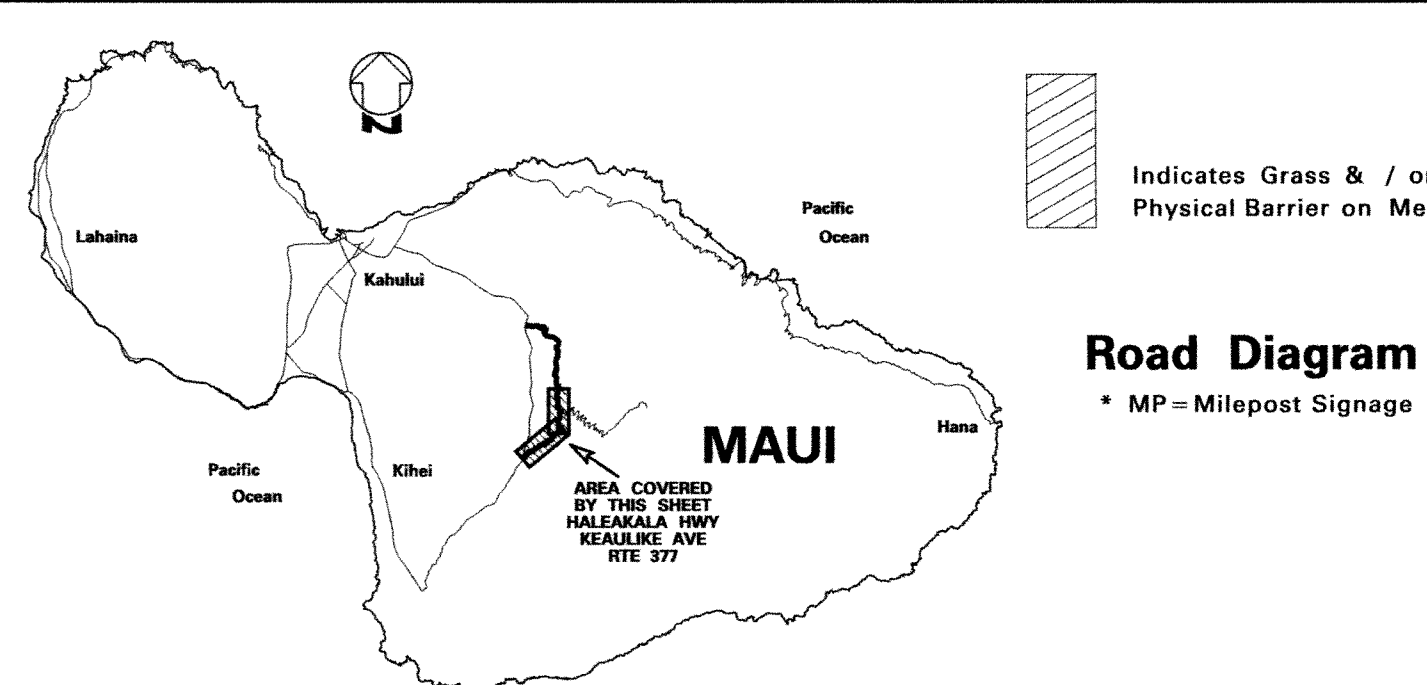

SCALE: (In Miles) 4" = 1 mile

	5	6	7	8	9	10
Shoulder: Width and Type	4' AC					
Pavement: Width and Type	18' AC					
Shoulder: Width and Type	4' AC					
Median: Width and Type	4' AC / 4' - 8' GRASS					
Shoulder: Width and Type	4' AC / 4' - 8' GRASS					
Pavement: Width and Type	20' AC					
Shoulder: Width and Type	4' AC / 4' - 8' GRASS					
Number of Traffic Lanes	2 - 9'					
Auxiliary Lanes and Parking Lanes: No. of Lanes and Width (Left Side)	2 - 10'					
Frontage Road: No. of Lanes, and Width (Right and Left)						
Sidewalk: Width and Type (Right and Left)						
Curb and/or Gutter: Type (Right and Left)	AC ROLLED CURBS					
Protective Devices: Type, Location and Number	ALL GUARDRAILS METAL W/ METAL, EXCEPT WHERE NOTED					
Illumination: Type, Location and Number						
Curves: Degree of Curvature (Right and Left)						
Superelevation (Range)						
Grades: % Grade, Positive or Negative	-4 -7 -6 +6 +7 +9					
Vertical Curve: Crest or Sag, Curve Limits						
Area and Development:	RURAL (99999)					
Terrain: 1-Flat, 2-Rolling, 3-Mountainous	ROLLING (2)					
Speed: 1-Design, 2-Posted	30 MPH (2)					
Intersection Control Devices: Type, Location and Cycle Timing						
Traffic Stations (Current Year)	874 0377 00100			847 0377 00601		
HPMS Sections - AADT 2011	2,300			1,300		
HPMS Sections - AADT 2010	2,222			1,430		
HPMS Sections - AADT 2009	2,200			1,416		
DOD Sections						
Census Tracts						
Functional Classification	MAJOR COLLECTOR (5)					
National Highway System (NHS)	NOT ON NHS (0)					
Previous Projects: Project No., Date and Limits	STP-0377(4) 1994 RESURFACE 377A-01-85M 1985 RESURFACE FAP-E-13A 1932 RS-0377(2) 1987 IMPROVEMENTS FAP-E-13A 1932 JOB #5569 1952 RESURFACE FAP - 5B 1929, 1933 FAP - 13A 1932, 1934 BF-037-1(1) 1962					

SCALE: (In Miles) 4" = 1 mile

Date Released	Oct 2004 GN
Revised	
FEB, 06 D.B.	
Nov, 06 D.B.	
Dec, 09 D.B.	
Feb, 11 D.B.	
Feb, 12 D.B.	
Sept, 12 E.P.J.	

ROAD INVENTORY MAUI RTE 378 HALEAKALA CRATER ROAD

STATE OF HAWAII
DEPARTMENT OF TRANSPORTATION
HIGHWAYS DIVISION
PREPARED BY THE
HIGHWAYS PLANNING BRANCH
IN COOPERATION WITH THE
U.S. DEPARTMENT OF TRANSPORTATION
FEDERAL HIGHWAY ADMINISTRATION

Total Route Length: 10.15 miles
a. Survey Length: 10.15 miles
b. Proposed Length: 0.00 miles
c. Other Length: * 0.00 miles

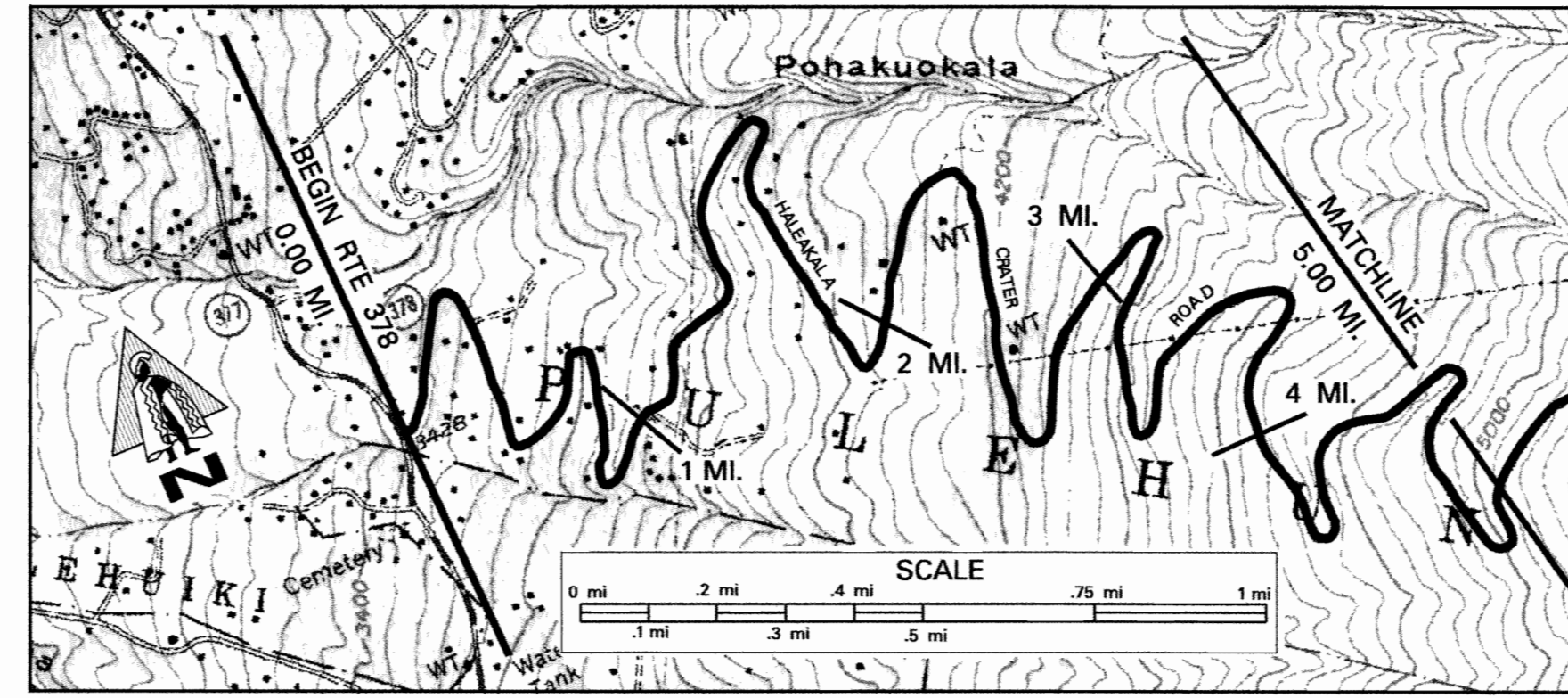

SCALE: (In Miles) 4" = 1 mile

Maintenance Control Sections : Length and Description

0.02	Begin 378A on Haleakala Crater Road 100' East of the centerline intersection with Haleakala Hwy (East Spur)	378A (10.13 MI)	4	5
------	---	-----------------	---	---

Structure Carrying Road
 Bridges (Over 20'): Length, Type, Capacity and Year Constructed
 Vertical Clearance
 Horizontal Clearance
Structure Over Road
 Vertical Clearance
 Horizontal Clearance

Right of Way Width (min.-max.) if varies	80'	2.96	3	4	5
Available Right of Way Width (Needs Study)	TREES AND BUSHES W/ SLIGHT CUT SLOPES	2.96			
Right of Way Fence: Type - Right and Left	W.F. - WIRE FENCE				
Control of Access: 1-None, 2-Partial, 3-Full	NONE				
Jurisdiction, Transfer Phase No. and Date (C to S or S to C)	STATE				
Project No., Type of Construction, and Year Constructed	(STP-0377(003), 2012 PREVENTIVE MAINT.)				
Project No., Type of Construction, and Year Constructed	(378A-01-92M 1993, RESURFACE)				

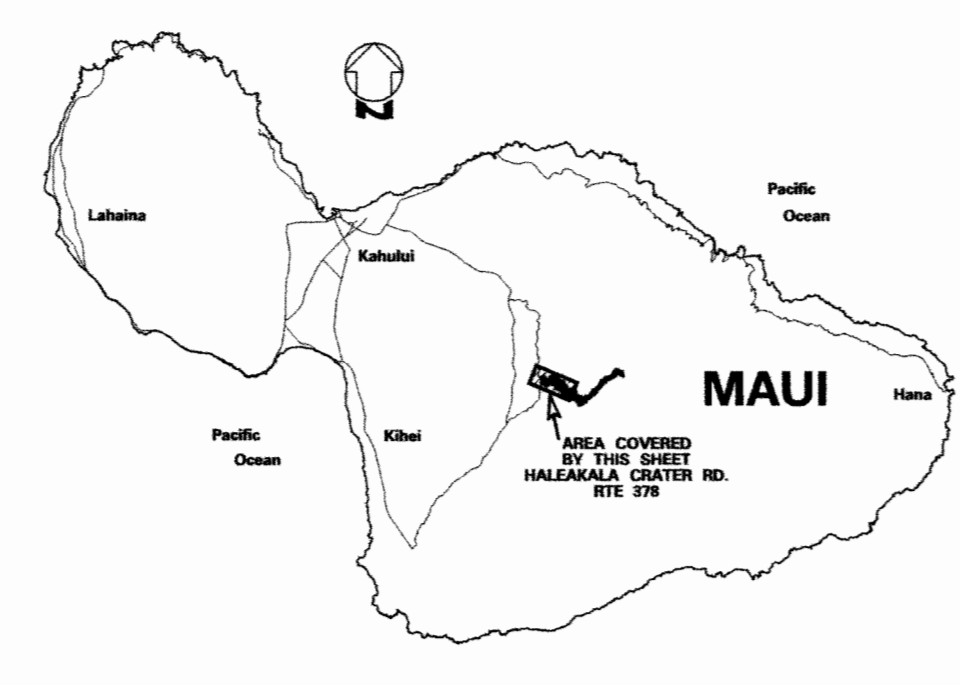

Road Diagram
* MP = Milepost Signage

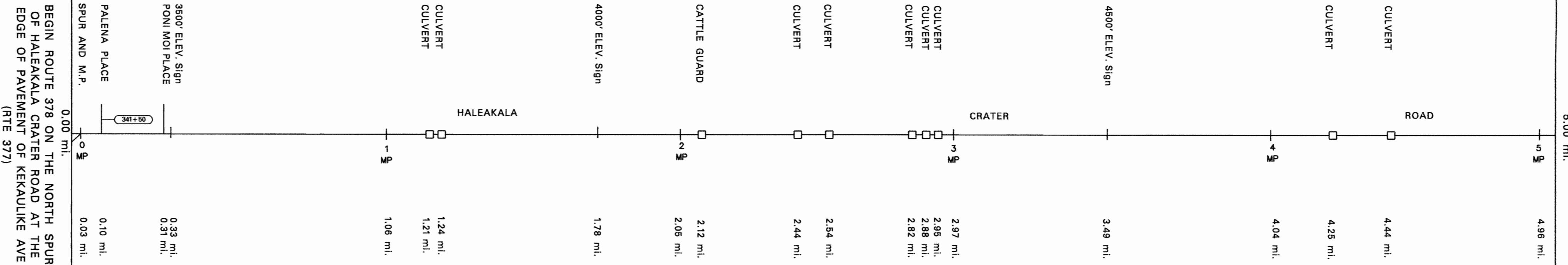

CONTINUES ON SHEET #2
5.00 mi.

SCALE: (In Miles) 4" = 1 mile

Divided Highway	Shoulder: Width and Type	2'-4' AC	2.12	3.72	4.08	4.28	4.88	5.00
	Pavement: Width and Type	22' AC	2.12	3.72	4.08	4.28	4.88	5.00
	Shoulder: Width and Type	2'-4' AC	2.12	3.72	4.08	4.28	4.88	5.00
	Median: Width and Type							
	Shoulder: Width and Type							
	Pavement: Width and Type							
	Shoulder: Width and Type							
Number of Traffic Lanes		2 - 1'						
Auxiliary Lanes and Parking Lanes: No. of Lanes and Width (Left Side)		NONE						
(Right Side)		NONE						
Frontage Road: No. of Lanes, and Width (Right and Left)								
Sidewalk: Width and Type (Right and Left)								
Curb and/or Gutter: Type (Right and Left)								
Protective Devices: Type, Location and Number		ALL GUARDRAILS METAL ON METAL						
Illumination: Type, Location and Number								
Curves: Degree of Curvature (Right and Left)		NONE						
Superelevation (Range)								
Grades: % Grade, Positive or Negative		+7, +8, +9						
Vertical Curve: Crest or Sag, Curve Limits								
Area and Development:		RURAL (99999)						
Terrain: 1-Flat, 2-Rolling, 3-Mountainous		MOUNTAINOUS (3)						
Speed: 1-Design, 2-Posted		30 MPH (2)						
Intersection Control Devices: Type, Location and Cycle Timing								
Traffic Stations (Current Year)		874 0378 00000						
HPMS Sections - AADT 2011		1,700						
HPMS Sections - AADT 2010		1,414						
HPMS Sections - AADT 2009		1,400						
DOD Sections								
Census Tracts								
Functional Classification		MAJOR COLLECTOR (5)						
National Highway System (NHS)		NOT ON NHS (0)						
Previous Projects: Project No., Date and Limits		0.02 378A-01-00MR 2003 MAINTENANCE & REPAIRS -0.04 (STP-0377(4) 1994 RESURFACE) 378A-01-92M 1993 RESURFACE 0.03 378A-02-67 1967 378A-01-92M 1982 (RESURFACE) 2.77 378A-03-68 1968 RESURFACE RS-0378(1) 1981 RESURFACE						

SCALE: (In Miles) 4" = 1 mile

Date Released	Revised
Oct 2004 GN	
Nov. 06 D.B.	
Feb. 11 D.B.	
Feb. 12 D.B.	
Sept. 12 E.P.J.	

ROAD INVENTORY MAUI RTE 378 HALEAKALA CRATER ROAD

STATE OF HAWAII
DEPARTMENT OF TRANSPORTATION
HIGHWAYS DIVISION

PREPARED BY THE
HIGHWAYS PLANNING BRANCH
IN COOPERATION WITH THE
U.S. DEPARTMENT OF TRANSPORTATION
FEDERAL HIGHWAY ADMINISTRATION

Total Route Length: 10.15 miles
a. Survey Length: 10.15 miles
b. Proposed Length: 0.00 miles
c. Other Length: * 0.00 miles

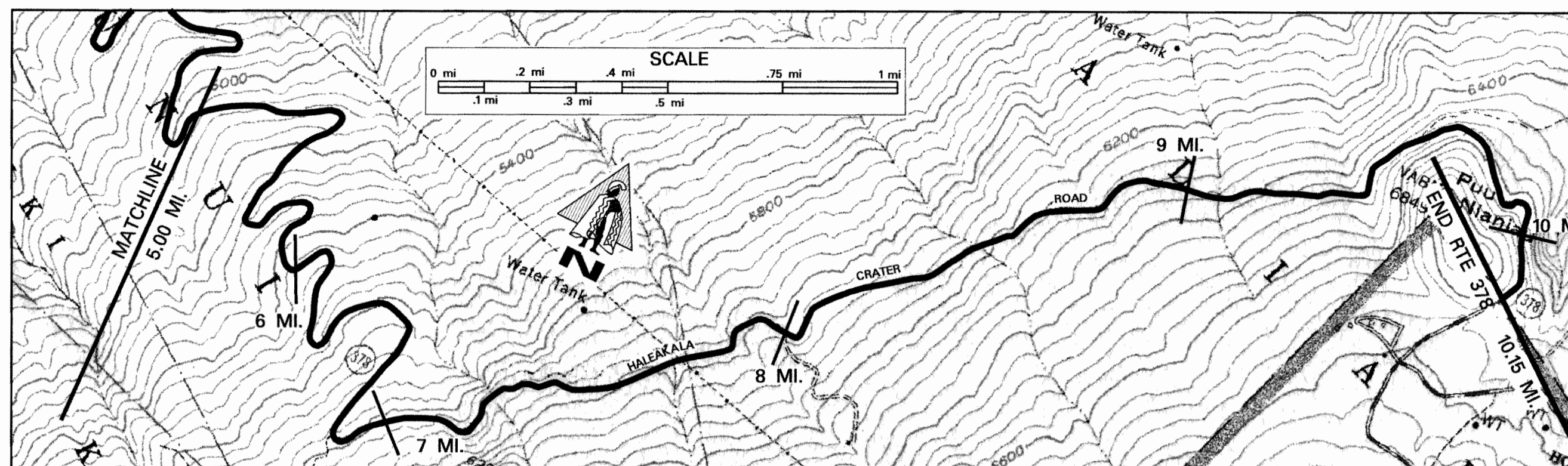

SCALE: (In Miles) 4" = 1 mile

Maintenance Control Sections : Length and Description	5	6	7	8	9	10
--	---	---	---	---	---	----

Structure Carrying Road						
Bridges (Over 20') : Length, Type, Capacity and Year Constructed	378A (10.15 MI)					
Vertical Clearance	PRESTRESSED BEAM 1934 (1970) H15					
Horizontal Clearance	97' 56'					
Vertical Clearance	27' 27'					
Horizontal Clearance	80'					
Right of Way Width (min.-max.) if varies	80'					
Available Right of Way Width (Needs Study)	OPEN PASTURE 1000' ACROSS					
Right of Way Fence : Type - Right and Left	N O N E					
Control of Access: 1-None, 2-Partial, 3-Full	N O N E					
Jurisdiction, Transfer Phase No. and Date (C to S or S to C)	S T A T E					
Project No., Type of Construction, and Year Constructed	378A-01-04M, RESURFACE, 2006					
Project No., Type of Construction, and Year Constructed	378A-01-00MR 2003 MAINTENANCE & REPAIRS					

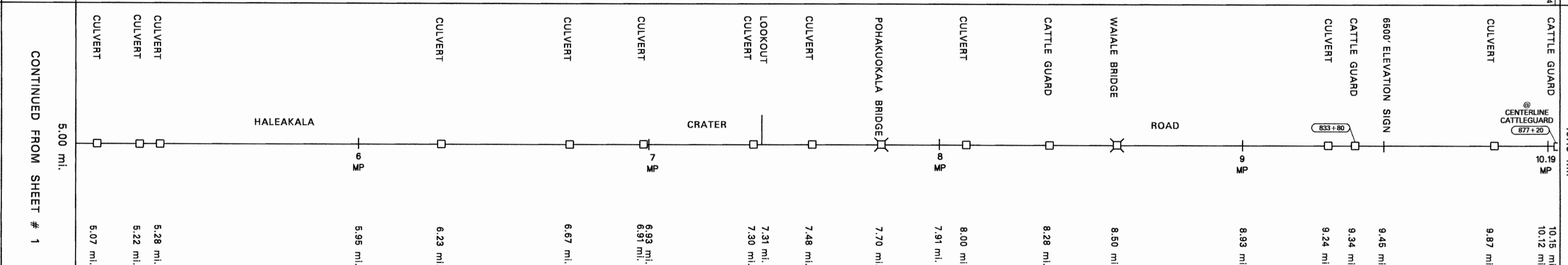
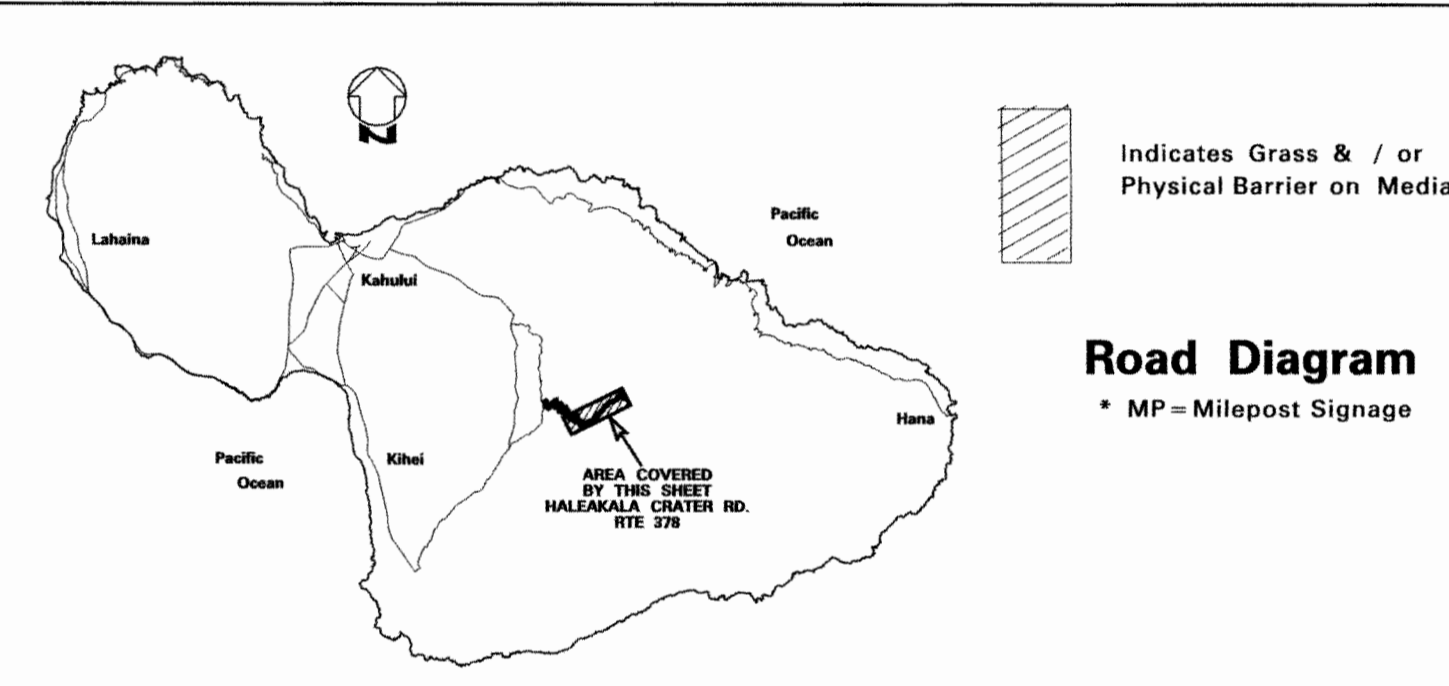

SCALE: (In Miles) 4" = 1 mile

Divided Highway	5	6	7	8	9	10
Shoulder: Width and Type	2' AC					
Pavement: Width and Type	(12' AC SHLR & BIKE PULL OUT)					
Shoulder: Width and Type	2' AC					
Median: Width and Type	2 - 11'					
Shoulder: Width and Type	N O N E					
Pavement: Width and Type	N O N E					
Shoulder: Width and Type	N O N E					
Number of Traffic Lanes	2 - 11'					
Auxiliary Lanes and Parking Lanes: No. of Lanes and Width (Left Side)	N O N E					
(Right Side)	N O N E					
Frontage Road: No. of Lanes, and Width (Right and Left)	N O N E					
Sidewalk: Width and Type (Right and Left)	N O N E					
Curb and/or Gutter: Type (Right and Left)	N O N E					
Protective Devices: Type, Location and Number	ALL GUARDRAILS ARE METAL ON METAL					
Illumination: Type, Location and Number	N O N E					
Curves: Degree of Curvature (Right and Left)	N O N E					
Superelevation (Range)	+7					
Grades: % Grade, Positive or Negative	+7					
Vertical Curve: Crest or Sag, Curve Limits	+7					
Area and Development:	RURAL (99999)					
Terrain: 1-Flat, 2-Rolling, 3-Mountainous	MOUNTAINOUS (3)					
Speed: 1-Design, 2-Posted	30 MPH (2)					
Intersection Control Devices: Type, Location and Cycle Timing	N O N E					
Traffic Stations (Current Year)	874 0378 00000					
HPMS Sections - AADT 2011	1,700					
HPMS Sections - AADT 2010	1,414					
HPMS Sections - AADT 2009	1,400					
DOD Sections	N O N E					
Census Tracts	N O N E					
Functional Classification	MAJOR COLLECTOR (5)					
National Highway System (NHS)	NOT ON NHS (0)					
Previous Projects: Project No., Date and Limits	RS-0378(1) 1981 RESURFACE					
	378A-01-92M 1993 RESURFACE					
	378A-03-68 1968 RESURFACE					
	378A-04-69 1969					
	FAP 5B (Group B) 1933					

SCALE: (In Miles) 4" = 1 mile

Date Released	Oct 2004 GN
Revised	
Nov., 06	D.B.
Feb 11	D.B.
Feb 12	D.B.
Sept. 12	E.P.J.

ROAD INVENTORY MAUI RTE 380 DAIRY ROAD, KUIHELANI HIGHWAY

STATE OF HAWAII
DEPARTMENT OF TRANSPORTATION
HIGHWAYS DIVISION
PREPARED BY THE
HIGHWAYS PLANNING BRANCH
IN COOPERATION WITH THE
U.S. DEPARTMENT OF TRANSPORTATION
FEDERAL HIGHWAY ADMINISTRATION

Total Designated Route Length:	6.18	MILES (a + b)
a. Existing Length:	6.18	MILES
b. Proposed Length:	0.00	MILES
Total Travel Way Length:	6.18	MILES (a + b, less c)
a. Existing Length:	6.18	MILES
b. Temporary Length:	0.00	MILES
c. Length used as T.W. for another Route:	0.00	MILES (-)

NEEDS STUDY ROUTE NO. _____ FUNCTIONAL CLASSIFICATION _____

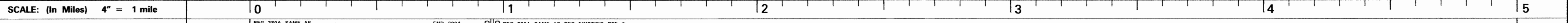
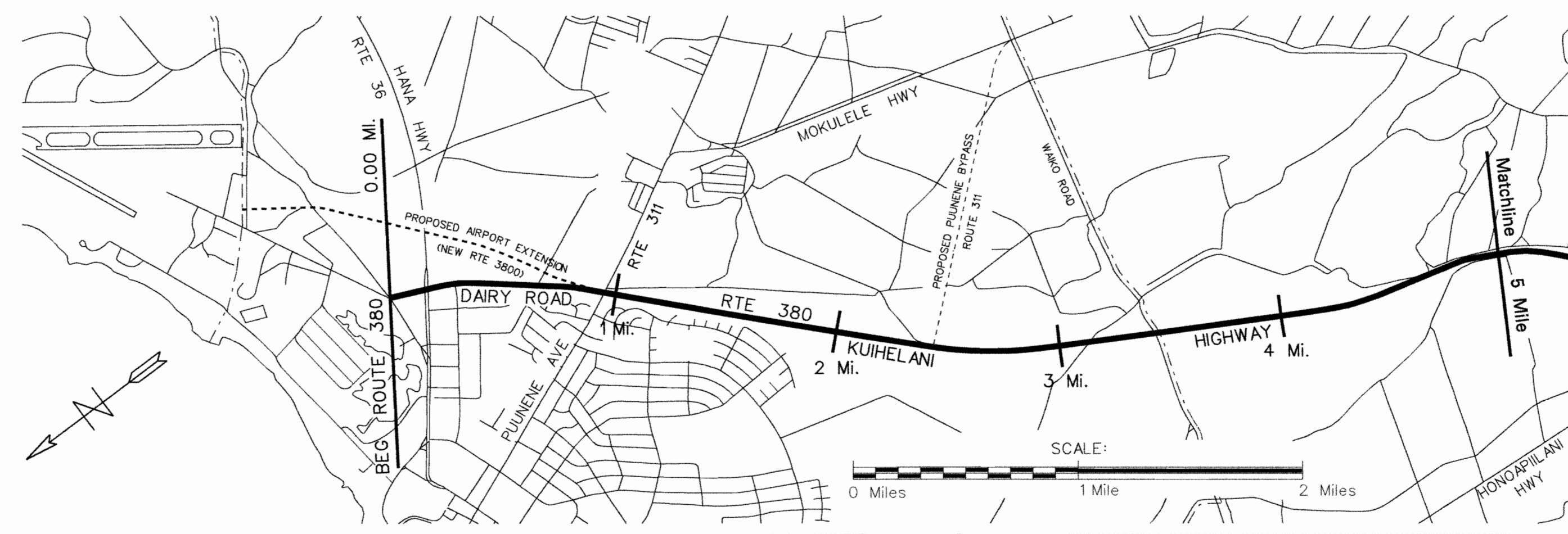

Maintenance Control Sections : Length and Description	0.00 mi. BEG. 380A SAME AS BEG. EXISTING RTE. ? 380A (0.95 mi.) ? END 380A SAME AS ROUTE 380 ? BEG. 380A SAME AS BEG. EXISTING RTE. ? 380 A (6.17 mi.)
---	--

Structure Carrying Road	Bridges (Over 20'): Length, Type, Capacity and Year Constructed	24' Slab, HS-20, 1970 67' Tee Beam, HS-20, 1970 77' Culvert, HS-20, 1970 25', Precast Conc Plank, HL-93, 2003 60', Precast Prestressed Conc Beam, HL-93, 2003 78', 3 Span Culvert, HL-93, 2003
	Vertical Clearance	3.15'
	Horizontal Clearance	1.44'
	Vertical Clearance	1.36'
Structure Over Road	Vertical Clearance	1.44'
	Horizontal Clearance	1.44'
	Vertical Clearance	1.36'
	Horizontal Clearance	1.36'
Right of Way Width (min.-max.) if varies		
Available Right of Way Width (Needs Study)		
Right of Way Fence: Type - Right and Left		
Control of Access: 1-None, 2-Partial, 3-Full		
Jurisdiction, Transfer Phase No. and Date (C to S or S to C)		
Project No., Type of Construction, and Year Constructed		
Project No., Type of Construction, and Year Constructed		

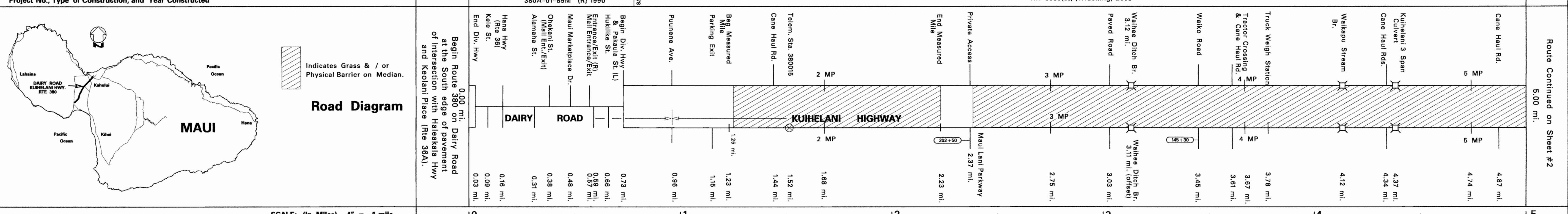

SCALE: (In Miles) 4" = 1 mile	0 1 2 3 4 5
-------------------------------	-------------

Divided Highway	Shoulder: Width and Type	4'-6" AC
	Pavement: Width and Type	(20' AC)
	Shoulder: Width and Type	4'-6" AC
	Median: Width and Type	10' Painted AC
	Shoulder: Width and Type	(22' AC)
	Pavement: Width and Type	4'-6" AC
Number of Traffic Lanes		
Auxiliary Lanes and Parking Lanes: No. of Lanes and Width (Left Side)		
(Right Side)		
Frontage Road: No. of Lanes, and Width (Right and Left)		
Sidewalk: Width and Type (Right and Left)		
Curb and/or Gutter: Type (Right and Left)		
Protective Devices: Type, Location and Number		
Illumination: Type, Location and Number		
Curves: Degree of Curvature (Right and Left)		
Superelevation (Range)		
Grades: % Grade, Positive or Negative		
Vertical Curve: Crest or Sag, Curve Limits		
Area and Development:		
Terrain: 1-Flat, 2-Rolling, 3-Mountainous		
Speed: 1-Design, 2-Posted		
Intersection Control Devices: Type, Location and Cycle Timing		
Traffic Stations (Current Year)		
HPMS Sections - AADT 2011		
HPMS Sections - AADT 2010		
HPMS Sections - AADT 2009		
DOD Sections		
Census Tracts		
Functional Classification		
National Highway System (NHS)		
Previous Projects: Project No., Date and Limits		

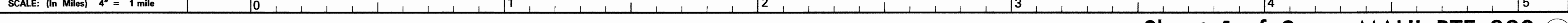

Date Released	July 2002, DB
Revised	Apr 03 DB Aug 04 DB Sep 04 DB Nov 06 DB Mar 09 DB Dec 09 DB Aug 10 DB Feb 11 DB Feb 12 DB Sep 12 DB

ROAD INVENTORY MAUI RTE 380 KUIHELANI HIGHWAY

STATE OF HAWAII
DEPARTMENT OF TRANSPORTATION
HIGHWAYS DIVISION

PREPARED BY THE
HIGHWAYS PLANNING BRANCH
IN COOPERATION WITH THE
U.S. DEPARTMENT OF TRANSPORTATION
FEDERAL HIGHWAY ADMINISTRATION

Total Designated Route Length:	6.18	MILES (a+b)
a. Existing Length:	6.18	MILES
b. Proposed Length:	0.00	MILES
Total Travel Way Length:	6.18	MILES (a+b, less c)
a. Existing Length:	6.18	MILES
b. Temporary Length:	0.00	MILES
c. Length used as T.W. for another Route:	0.00	MILES (-)
NEEDS STUDY ROUTE NO.		FUNCTIONAL CLASSIFICATION

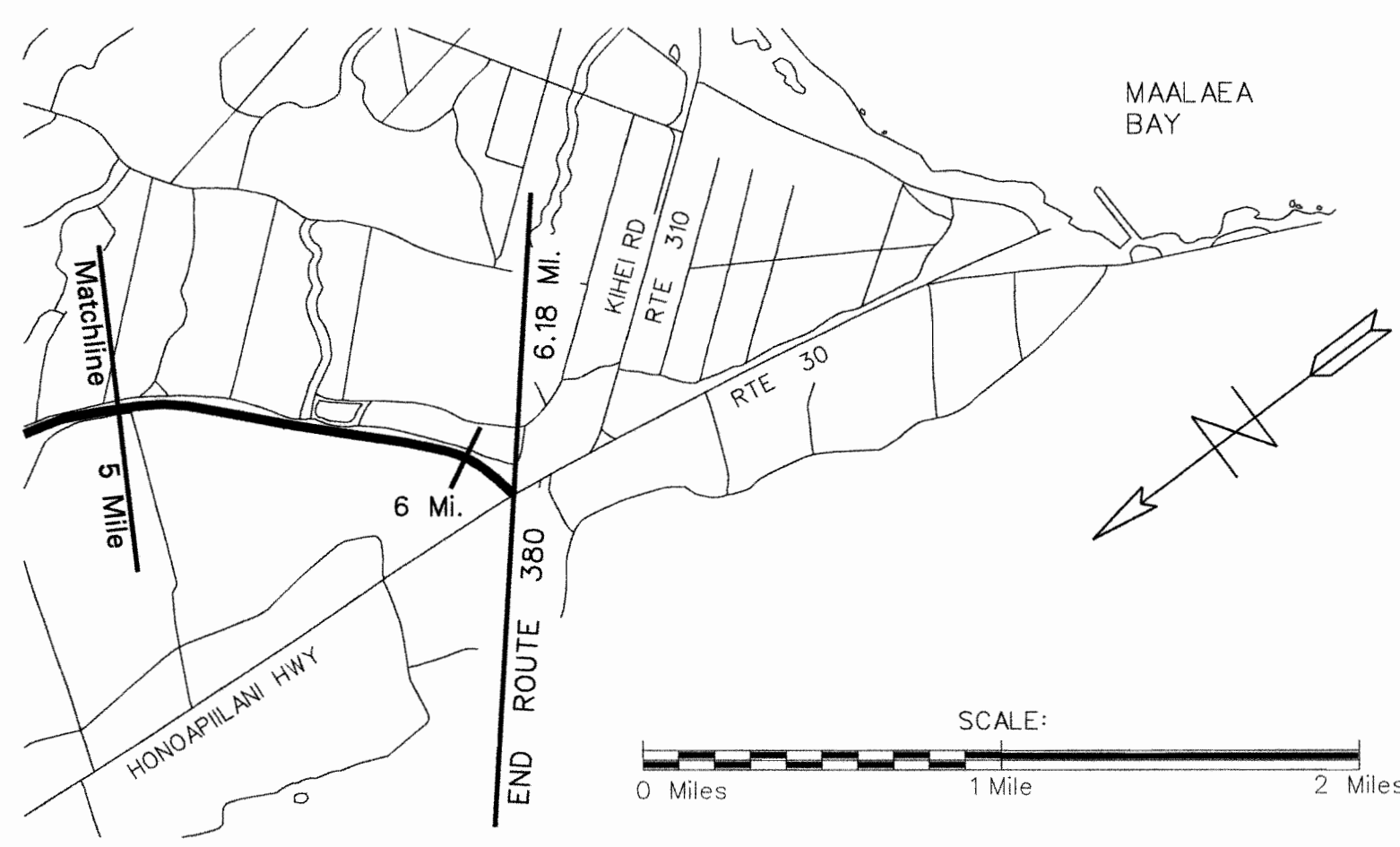

SCALE: (In Miles) 4" = 1 mile

Maintenance Control Sections : Length and Description	5	6	7	8	9	10
---	---	---	---	---	---	----

Structure Carrying Road		37' SLAB 1970 HS-20 PRECAST, PRESTRESSED CONC. 47' BEAM, HL-93, 2003				
Structure Over Road		Vertical Clearance Horizontal Clearance	88' 44" 36'			
Right of Way Width (min.-max.) if varies		150' - 210'				
Available Right of Way Width (Needs Study)		CLEAR 1000' - SUGAR CANE 30' FROM PAVEMENT				
Right of Way Fence: Type - Right and Left		NONE				
Control of Access: 1-None, 2-Partial, 3-Full		STATE				
Jurisdiction, Transfer Phase No. and Date (C to S or S to C)		NH-0380(11), Prevent. Maint., 2009				
Project No., Type of Construction, and Year Constructed		NH-0380(9) (Widening) 2003				
Project No., Type of Construction, and Year Constructed		[BR-NH-030-1124) (Widening) 2002]				

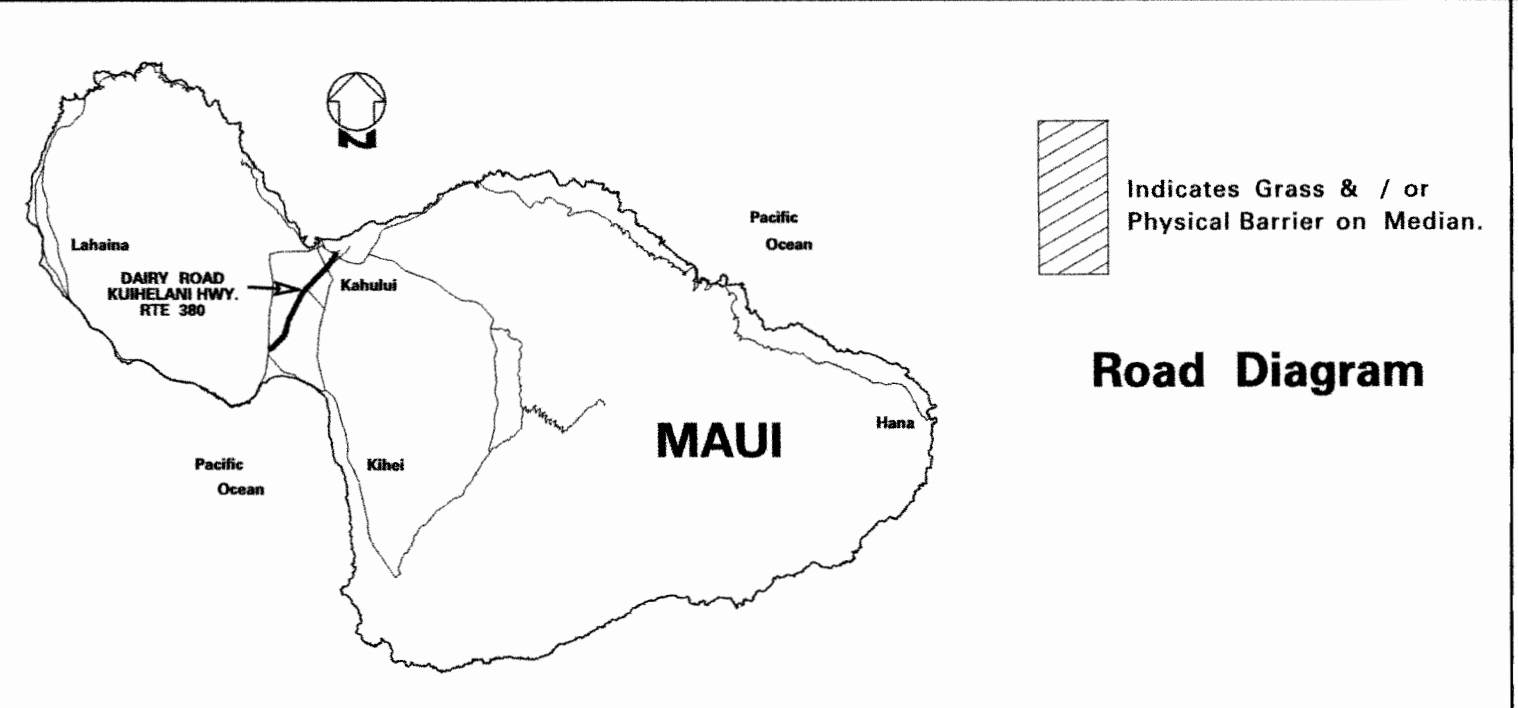

SCALE: (In Miles) 4" = 1 mile

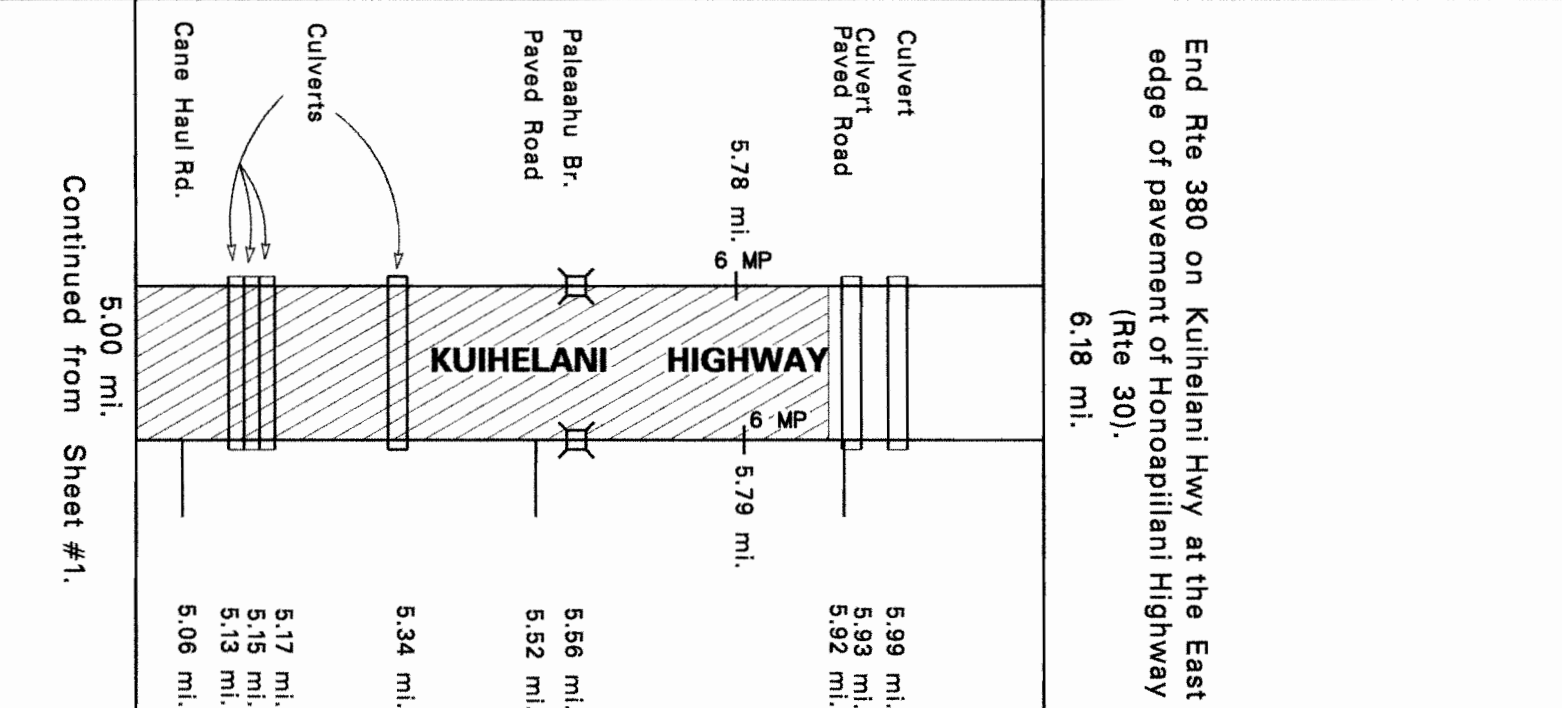

Shoulder: Width and Type		10' AC		12' AC		24' AC
Pavement: Width and Type		24' AC		12' AC		24' AC
Shoulder: Width and Type		10' AC		0		0
Median: Width and Type		18' Grass	10'-18' AC	10' Painted AC		0
Shoulder: Width and Type		4' AC		12' AC		38' AC
Pavement: Width and Type		24' AC		12' AC		44' AC
Shoulder: Width and Type		10' AC		0		0
Number of Traffic Lanes		4 - 12'		2-12' (R)		2-12' (R)
Auxiliary Lanes and Parking Lanes: No. of Lanes and Width (Left Side)				12-12' (R)		12-14' (R)
(Right Side)				Double (L) TL		Single (R) TL
Frontage Road: No. of Lanes, and Width (Right and Left)				11-12' (R)		11-14' (R)
Sidewalk: Width and Type (Right and Left)						
Curb and/or Gutter: Type (Right and Left)						
Protective Devices: Type, Location and Number						
Illumination: Type, Location and Number						
Curves: Degree of Curvature (Right and Left)						
Superelevation (Range)						
Grades: % Grade, Positive or Negative		+2				
Vertical Curve: Crest or Sag, Curve Limits						
Area and Development:		Small Urban (99998)				
Terrain: 1-Flat, 2-Rolling, 3-Mountainous		Flat (1)				
Speed: 1-Design, 2-Posted		45 MPH (1)		Not Posted		35 MPH (1)
Intersection Control Devices: Type, Location and Cycle Timing						3 Phase Traffic Signal
Traffic Stations (Current Year)		B74 0380 00345				
HPMS Sections - AADT 2011		16,768				
HPMS Sections - AADT 2010		15,857				
HPMS Sections - AADT 2009		15,700				
DOD Sections						
Census Tracts						
Functional Classification		Principal Arterial (3)				
National Highway System (NHS)		On NHS (1)				
Previous Projects: Project No., Date and Limits		380A-01-99M (R) 2000				
		380A-01-89M (R), 1990				
		S-0380 (6), 1971				
		S-038 (6), 1969				

SCALE: (In Miles) 4" = 1 mile

Date Released
July 2002, DB
Revised
Nov. 06 D.B.
Dec. 09 D.B.
Feb. 11 D.B.
Feb. 12 D.B.
Sept. 12 E.P.J.

ROAD INVENTORY MAUI RTE 3000 HONOAPIILANI HIGHWAY BYPASS

STATE OF HAWAII
DEPARTMENT OF TRANSPORTATION
HIGHWAYS DIVISION
PREPARED BY THE
HIGHWAYS PLANNING BRANCH
IN COOPERATION WITH THE
U.S. DEPARTMENT OF TRANSPORTATION
FEDERAL HIGHWAY ADMINISTRATION

Total Route Length: 8.95 miles
a. Survey Length: 0.00 miles
b. Proposed Length: 8.95 miles
c. Other Length: * 0.00 miles

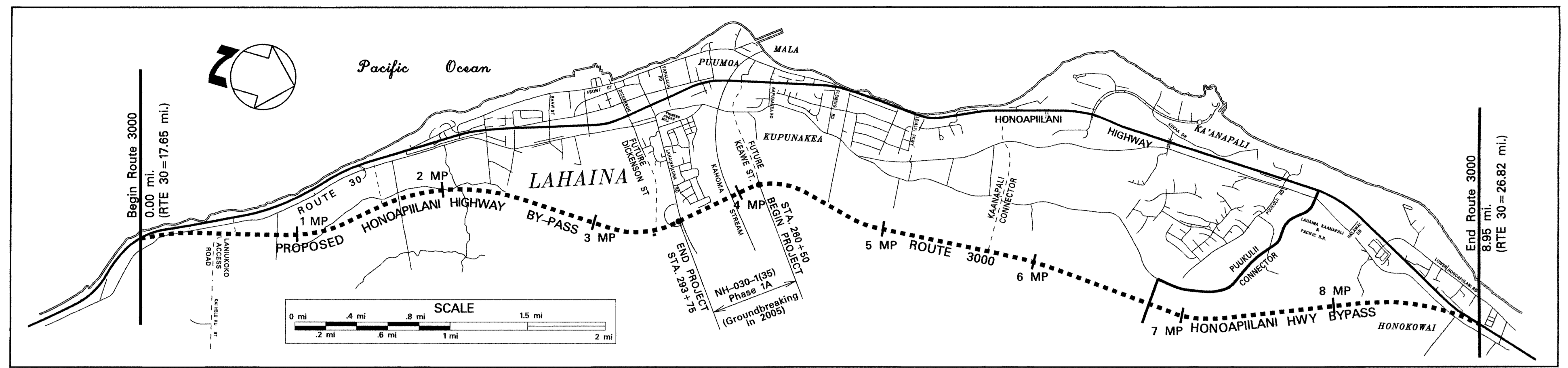

SCALE: (In Miles) 2" = 1 mile

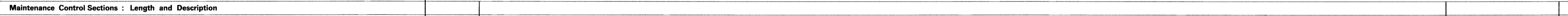

Maintenance Control Sections : Length and Description	0	1	2	3	4	5	6	7	8	9	10
Structure Carrying Road											
Bridges (Over 20'): Length, Type, Capacity and Year Constructed	4-CELL BOX 3-CELL BOX 400' 400' 600' 400' 400' 800'										
Vertical Clearance											
Horizontal Clearance											
Structure Over Road											
Vertical Clearance											
Horizontal Clearance											
Right of Way Width (min.-max.) if varies											
Available Right of Way Width (Needs Study)											
Right of Way Fence: Type - Right and Left											
Control of Access: 1-None, 2-Partial, 3-Full											
Jurisdiction, Transfer Phase No. and Date (C to S or S to C)											
Project No., Type of Construction, and Year Constructed											
Project No., Type of Construction, and Year Constructed											

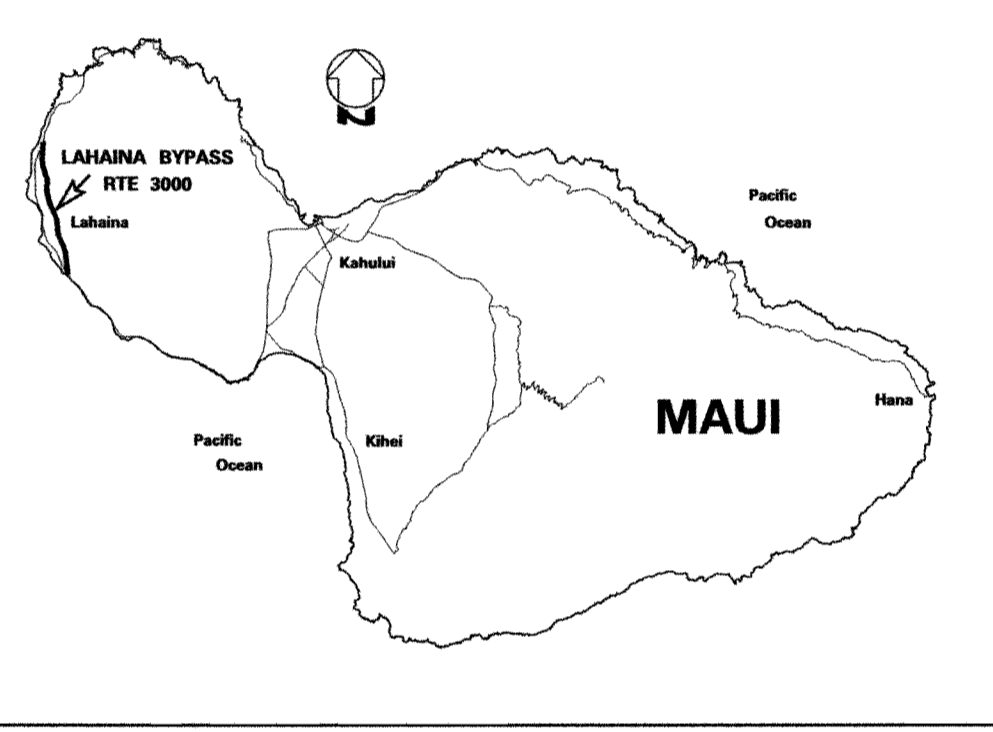

Road Diagram
• MP = Milepost Signage

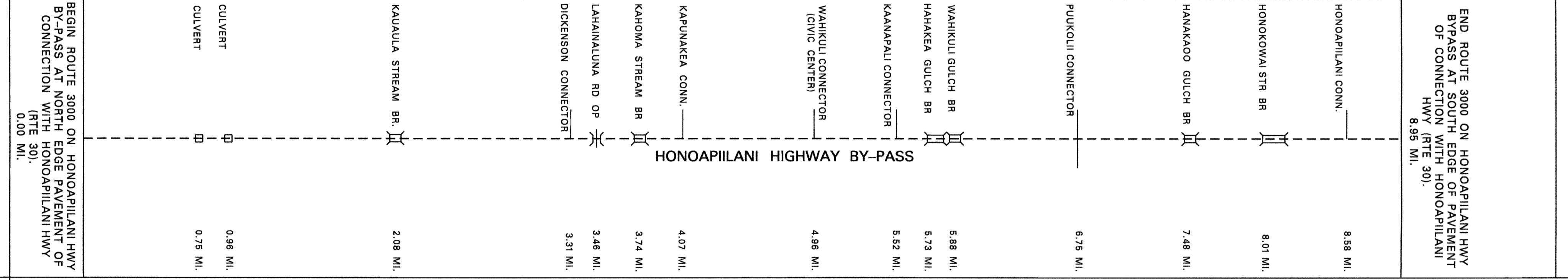

SCALE: (In Miles) 2" = 1 mile



Divided Highway	0	1	2	3	4	5	6	7	8	9	10
Shoulder: Width and Type											
Pavement: Width and Type											
Shoulder: Width and Type											
Median: Width and Type											
Median Barriers:											
Shoulder: Width and Type											
Pavement: Width and Type											
Shoulder: Width and Type											
Number of Traffic Lanes											
Auxiliary Lanes and Parking Lanes: No. of Lanes and Width (Left Side)											
(Right Side)											
Frontage Road: No. of Lanes, and Width (Right and Left)											
Sidewalk: Width and Type (Right and Left)											
Curb and/or Gutter: Type (Right and Left)											
Protective Devices: Type, Location and Number											
Illumination: Type, Location and Number											
Curves: Degree of Curvature (Right and Left)											
Superelevation (Range)											
Grades: % Grade, Positive or Negative											
Vertical Curve: Crest or Sag, Curve Limits											
Area and Development:	SMALL URBAN (99998) 4.19 RURAL (99999)										
Terrain: 1-Flat, 2-Rolling, 3-Mountainous											
Speed: 1-Design, 2-Posted											
Intersection Control Devices: Type, Location and Cycle Timing											
Traffic Station											
HPMS Section - AADT											
HPMS Section - AADT											
HPMS Section - AADT											
DOD Sections											
Census Tracts											
Functional Classification	PRINCIPLE ARTERIAL (3)										
National Highway System (NHS)	ON NHS - UNBUILT										
Previous Projects: Project No., Date and Limits											

SCALE: (In Miles) 2" = 1 mile



Date Released	Revised
Dec 2004 JK	
Nov. 06 D.B.	
Feb. 09 D.B.	
Feb. 11 D.B.	
Feb. 12 D.B.	
Sept. 12 E.P.J.	

ROAD INVENTORY MAUI RTE 3400 KAHULUI BEACH ROAD AND WAIEHU BEACH ROAD

STATE OF HAWAII
DEPARTMENT OF TRANSPORTATION
HIGHWAYS DIVISION

PREPARED BY THE
HIGHWAYS PLANNING BRANCH
IN COOPERATION WITH THE
U.S. DEPARTMENT OF TRANSPORTATION
FEDERAL HIGHWAY ADMINISTRATION

Total Route Length: 2.62 miles
 a. Survey Length: 2.62 miles
 b. Proposed Length: 0.00 miles
 c. Other Length: * 0.00 miles

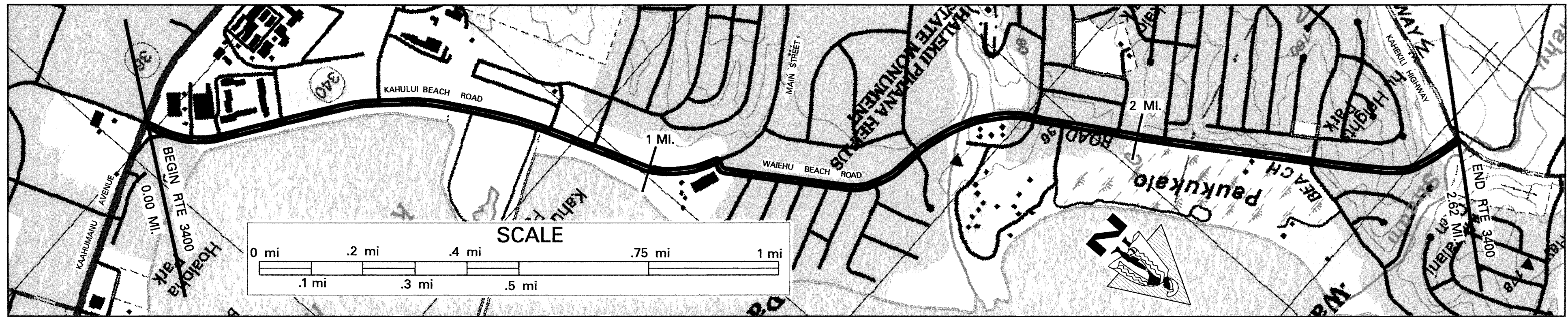

End 3400A on Main St. spur 80' N.W. of the centerline intersection with Waiehu Beach Rd. and Kahului Beach Rd. End 3400A and begin 3400B on Waiehu Beach Rd. 100' N. of centerline intersection with Kahului Beach Rd.
 End 3400B and begin 3400C on Waiehu Beach Rd. 50' East of centerline intersection of Waiehu Beach Rd. and Kahukalo Hwy. Also begin 3400C on Kahukalo Hwy - see Route 340.

SCALE: (In Miles) 4" = 1 mile

Maintenance Control Sections : Length and Description	0.000 MI	3400A (1.11 MI) / SPUR 3400A (0.02 MI)	1.15	3400B (1.46 MI)	2.61	3400C (0.01 MI)	3
---	----------	--	------	-----------------	------	-----------------	---

Structure Carrying Road	Bridges (Over 20'): Length, Type, Capacity and Year Constructed	TEE BEAM 1953 H20 182'					
	Vertical Clearance			28'			
Structure Under Road	Horizontal Clearance						
	Vertical Clearance						

Right of Way Width (min.-max.) if varies	120'	80' - 200'	70' - 240'	
Available Right of Way Width (Needs Study)	COMMERCIAL / RESIDENTIAL	BRUSH	SAND	
Right of Way Fence: Type - Right and Left	NONE			
Control of Access: 1-None, 2-Partial, 3-Full	STATE			
Jurisdiction, Transfer Phase No. and Date (C to S or S to C)	3400AB-02-90 1992 IMPROVEMENTS	3400A-01-07M, RESURFACING, 2009	3400A-02-91 IMPROVEMENTS 1995	3400B-01-10M, RESURFACE, 2011
Project No., Type of Construction, and Year Constructed	3400A-02-91 IMPROVEMENTS 1995	HWY-M-05-04, IMPR. 2006	3400A-02-91 IMPROVEMENTS 1995	3400B-01-07M 1998 RESURFACE (ALSO ROUTE 340)
Project No., Type of Construction, and Year Constructed				3400B-02-98 2 WAY (L) TLS 2011
				3400B-01-97M 1998 RESURFACE (ALSO ROUTE 340)

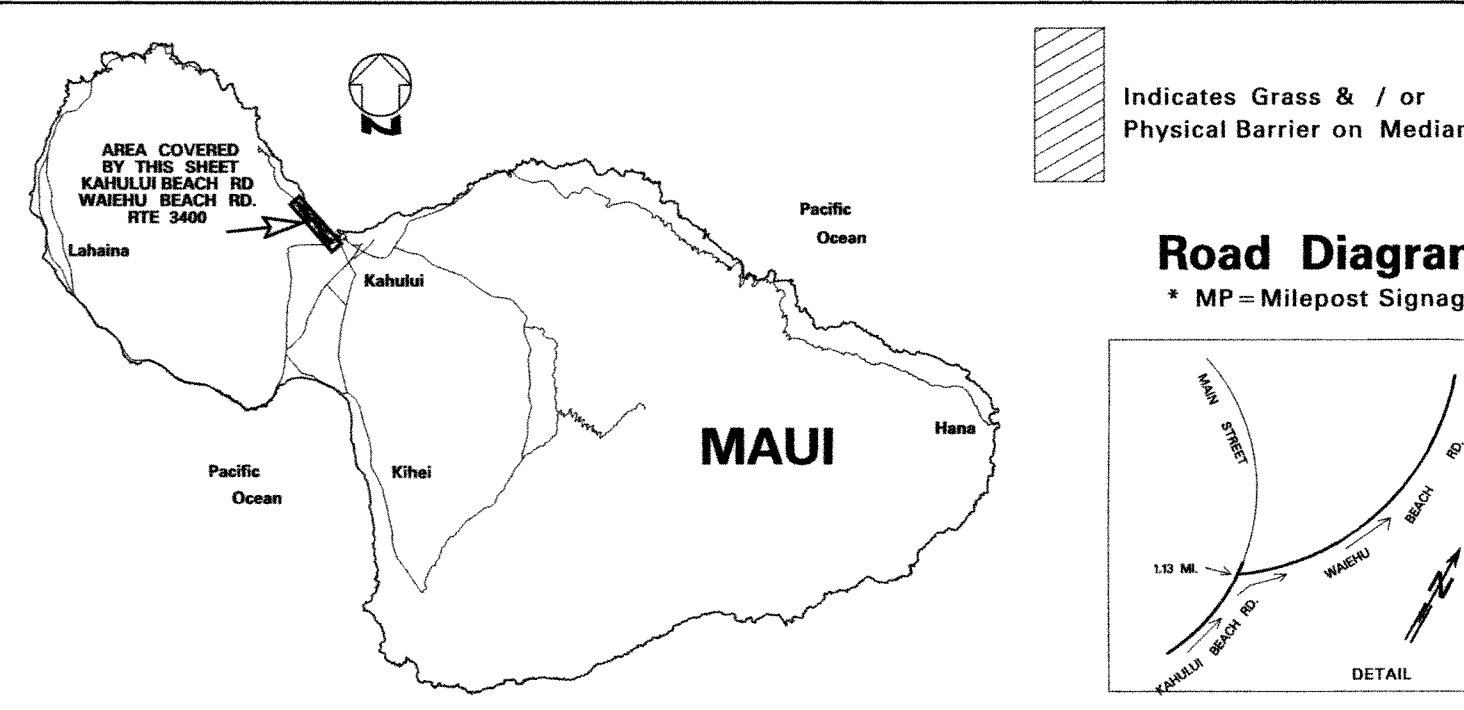

SCALE: (In Miles) 4" = 1 mile

Divided Highway	Shoulder: Width and Type	4' AC	6' AC	11' AC	4' - 6' AC	6' AC	6' AC	6' AC	6' AC
	Pavement: Width and Type	12' AC	36' AC	24' AC	12' AC	24' AC	12' AC	24' AC	24' AC
	Shoulder: Width and Type	0'	0'	0'	0'	0'	0'	0'	0'
	Median: Width and Type	0'	0'	0'	0'	0'	0'	0'	0'
	Shoulder: Width and Type	4' AC	6' AC	11' AC	4' - 6' AC	6' AC	6' AC	6' AC	6' AC
Number of Traffic Lanes	2	2	4	2	2	2	2	2	2
Auxiliary Lanes and Parking Lanes: No. of Lanes and Width (Left Side)	ALL T.L.S. 12' UNLESS NOTED	ALL T.L.S. 12' UNLESS NOTED	ALL T.L.S. 12' UNLESS NOTED	ALL T.L.S. 12' UNLESS NOTED	ALL T.L.S. 12' UNLESS NOTED	ALL T.L.S. 12' UNLESS NOTED	ALL T.L.S. 12' UNLESS NOTED	ALL T.L.S. 12' UNLESS NOTED	ALL T.L.S. 12' UNLESS NOTED
Frontage Road: No. of Lanes, and Width (Right and Left)									
Sidewalk: Width and Type (Right and Left)									
Curb and/or Gutter: Type (Right and Left)	T.S. = TRIANGULAR SWALE C. & G. = CURB & GUTTER	B.C. = BITUMINOUS CURB L.D.D. = LINED DRAINAGE DITCH							
Protective Devices: Type, Location and Number									
Illumination: Type, Location and Number	MV	MV	1 MV	MV					
Curves: Degree of Curvature (Right and Left)									
Superelevation (Range)									
Grades: % Grade, Positive or Negative									
Vertical Curve: Crest or Sag, Curve Limits									
Area and Development:									
Terrain: 1-Flat, 2-Rolling, 3-Mountainous			FLAT (1)				ROLLING (2)		
Speed: 1-Design, 2-Posted			35 MPH (2)	30 MPH (2)	30 MPH (2)		30 MPH (2)		
Intersection Control Devices: Type, Location and Cycle Timing			3 PHASE	3 PHASE					
Traffic Stations (Current Year)	874 3400 00000	874 3400 00046	874 3400 00113	874 3400 00232					
HPMS Sections - AADT 2011	30,800	28,900	11,200	6,700					
HPMS Sections - AADT 2010	26,563	38,270	12,524	6,161					
HPMS Sections - AADT 2009	26,300	37,891	12,400	6,100					
DOD Sections									
Census Tracts									
Functional Classification			MINOR ARTERIAL (4)						
National Highway System (NHS)			NOT ON NHS (0)						
Previous Projects: Project No., Date and Limits		3400A-02-91 1995 IMPROVEMENTS	3400B-01-97M 1998 RESURFACE (ALSO ROUTE 340)	3400A-01-88M 1988 RESURFACE			3400A-01-88M 1988 RESURFACE		
		S-0340 (1) 1955, 1956	COUNTY	S-247(1) 1952, 1953			S-0341(3) 1966, 1967		

SCALE: (In Miles) 4" = 1 mile

Date Released	Oct 2004 GN
Revised	
Nov. 06	D.B.
Dec. 09	D.B.
Feb. 11	D.B.
Feb. 12	D.B.
Sept. 12	E.P.J.

ROAD INVENTORY MAUI RTE 3500 PUUNENE AVENUE

STATE OF HAWAII
DEPARTMENT OF TRANSPORTATION
HIGHWAYS DIVISION

PREPARED BY THE
HIGHWAYS PLANNING BRANCH
IN COOPERATION WITH THE
U.S. DEPARTMENT OF TRANSPORTATION
FEDERAL HIGHWAY ADMINISTRATION

Total Route Length: 1.11 miles

a. Survey Length: 1.11 miles

b. Proposed Length: 0.00 miles

c. Other Length: * 0.00 miles

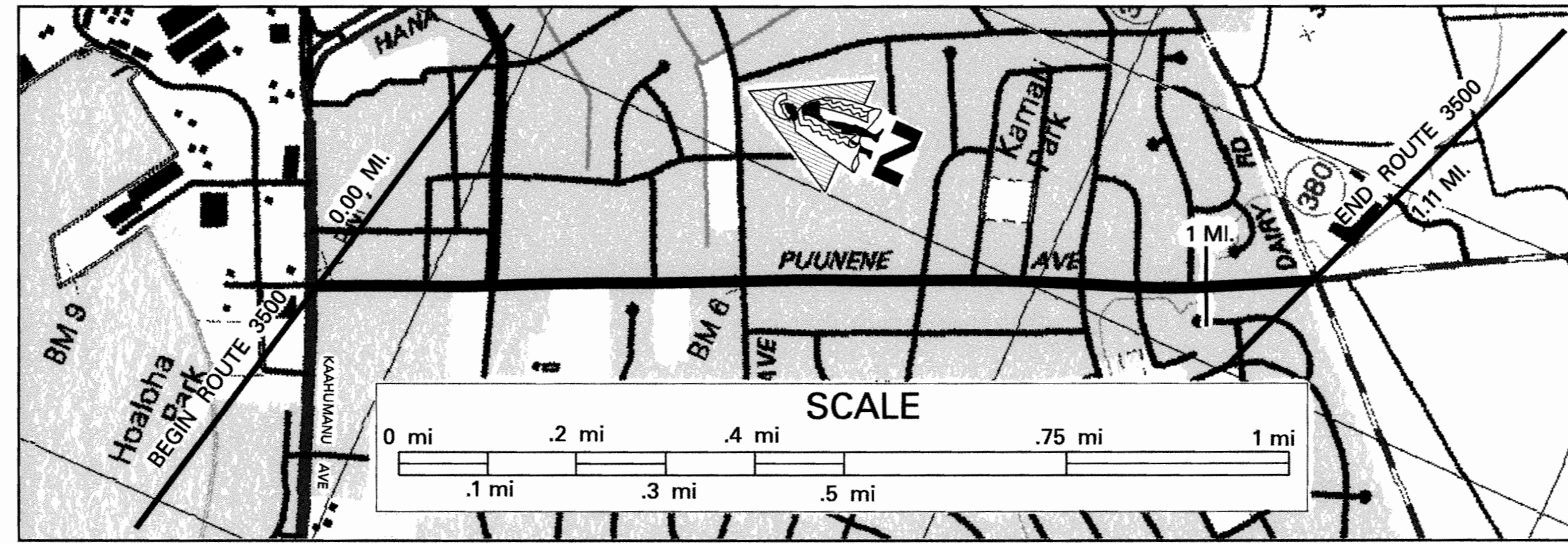

SCALE: (In Miles) 4" = 1 mile

Maintenance Control Sections : Length and Description

0.00 mi. Begin 3500A on Puunene Avenue 85' S. of centerline with Kaahumanu Avenue. 1.11 mi. End 3500A on Puunene Avenue 10' from the S.E. edge of pavement of Kuihelani Hwy.

Structure Carrying Road

Bridges (Over 20'): Length, Type, Capacity and Year Constructed

Vertical Clearance

Horizontal Clearance

Structure Over Road

Vertical Clearance

Horizontal Clearance

Right of Way Width (min.-max.) if varies

Available Right of Way Width (Needs Study)

Right of Way Fence: Type - Right and Left

Control of Access: 1-None, 2-Partial, 3-Full

Jurisdiction, Transfer Phase No. and Date (C to S or S to C)

Project No., Type of Construction, and Year Constructed

Project No., Type of Construction, and Year Constructed

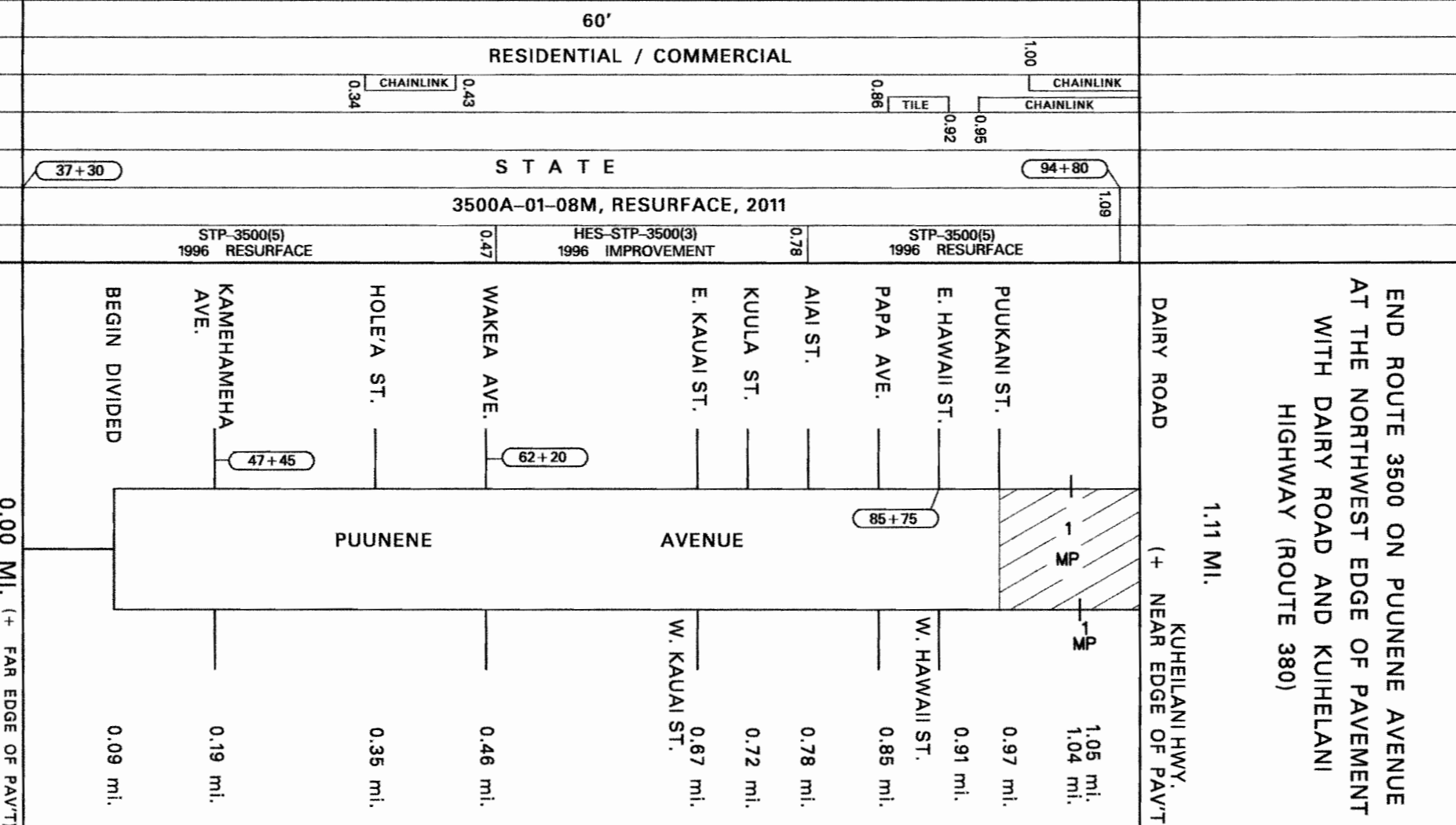

SCALE: (In Miles) 4" = 1 mile

Shoulder: Width and Type

Pavement: Width and Type

Shoulder: Width and Type

Median: Width and Type

Shoulder: Width and Type

Pavement: Width and Type

Shoulder: Width and Type

Shoulder: Width and Type

Number of Traffic Lanes

Auxiliary Lanes and Parking Lanes: No. of Lanes and Width (Left Side)

(Right Side)

Frontage Road: No. of Lanes, and Width (Right and Left)

Sidewalk: Width and Type (Right and Left)

Curb and/or Gutter: Type (Right and Left)

Protective Devices: Type, Location and Number

Illumination: Type, Location and Number

Curves: Degree of Curvature (Right and Left)

Superelevation (Range)

Grades: % Grade, Positive or Negative

Vertical Curve: Crest or Sag, Curve Limits

Area and Development:

Terrain: 1-Flat, 2-Rolling, 3-Mountainous

Speed: 1-Design, 2-Posted

Intersection Control Devices: Type, Location and Cycle Timing

Traffic Stations (Current Year)

HPMS Sections - AADT 2011

HPMS Sections - AADT 2010

HPMS Sections - AADT 2009

DOD Sections

Census Tracts

Functional Classification

National Highway System (NHS)

Previous Projects: Project No., Date and Limits

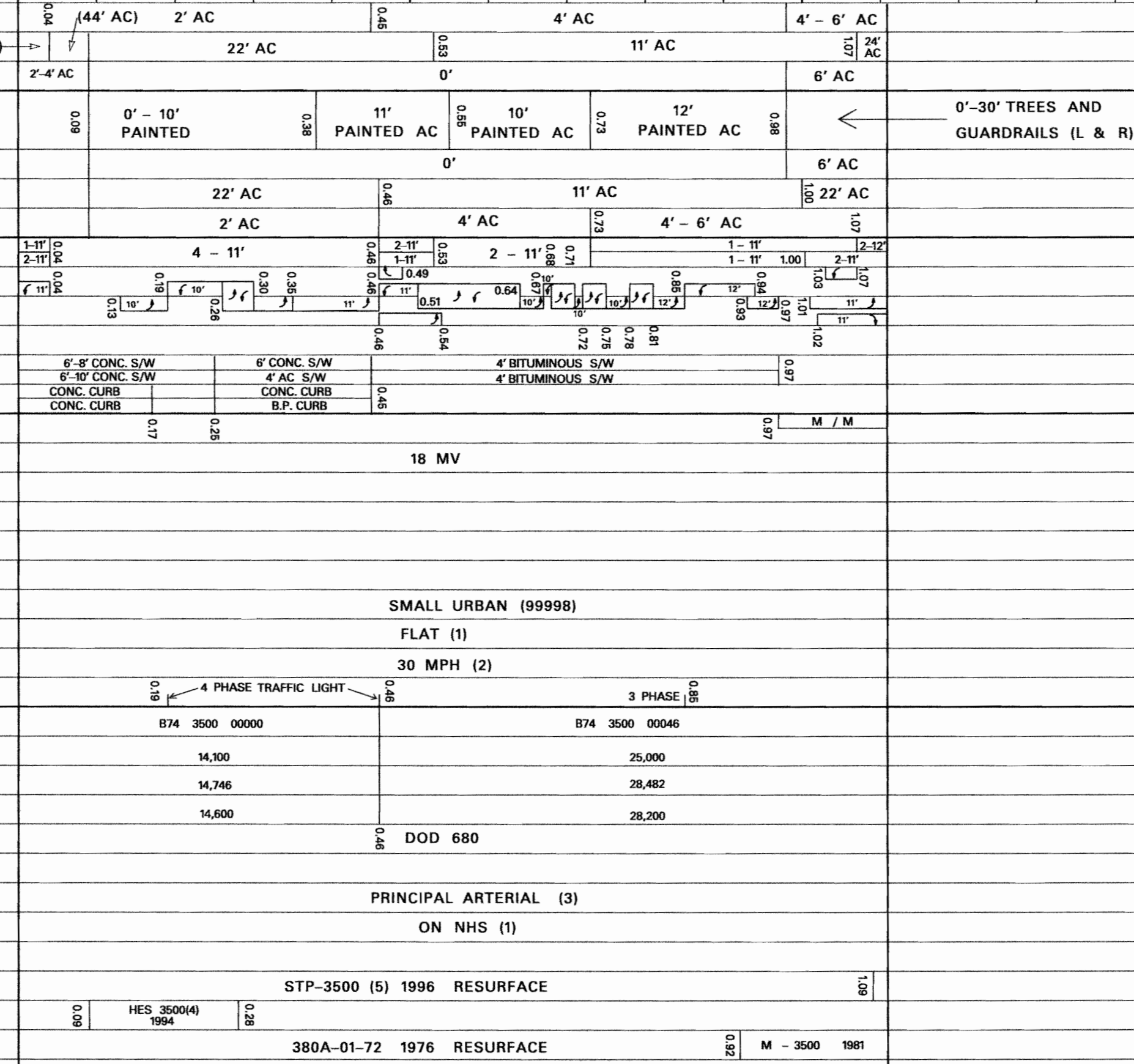

SCALE: (In Miles) 4" = 1 mile

Date Released	Revised
Oct 2004 GN	
FEB, 06 D.B.	
Nov., 06 D.B.	
Dec. 09 D.B.	
Feb. 11 D.B.	
Feb. 12 D.B.	
Sept. 12 E.P.J.	

ROAD INVENTORY MAUI RTE 3800 PROPOSED AIRPORT EXTENSION

STATE OF HAWAII
DEPARTMENT OF TRANSPORTATION
HIGHWAYS DIVISION
PREPARED BY THE
HIGHWAYS PLANNING BRANCH
IN COOPERATION WITH THE
U.S. DEPARTMENT OF TRANSPORTATION
FEDERAL HIGHWAY ADMINISTRATION

Total Designated Route Length: 1.67 MILES (a + b)
 a. Existing Length: 0.00 MILES
 b. Proposed Length: 1.67 MILES
 Total Travel Way Length: 0.00 MILES (a + b, less c)
 a. Existing Length: 0.00 MILES
 b. Temporary Length: 0.00 MILES
 c. Length used as T.W. for another Route: 0.00 MILES (-)

NEEDS STUDY ROUTE NO. _____ FUNCTIONAL CLASSIFICATION _____

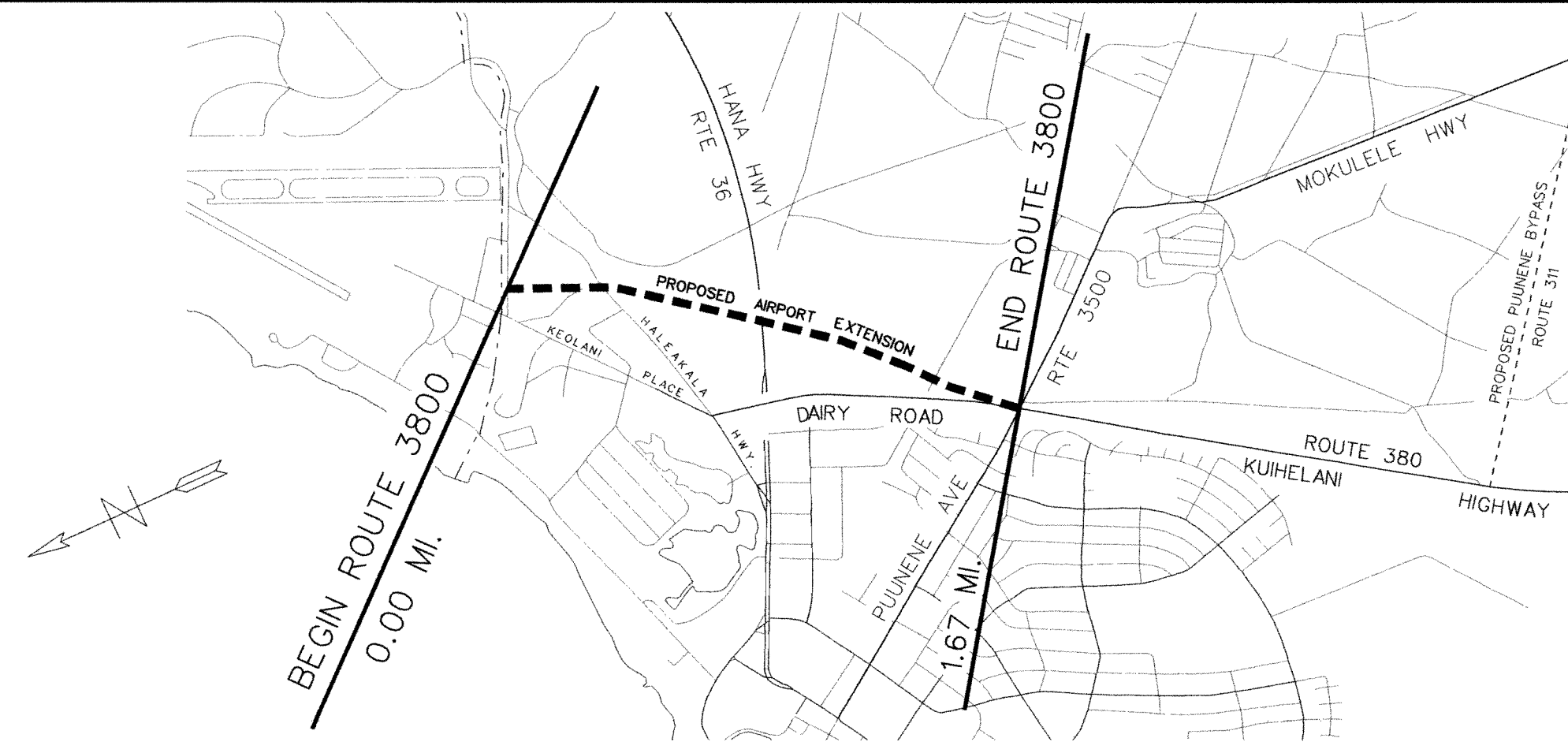

SCALE: (In Miles) 4" = 1 mile

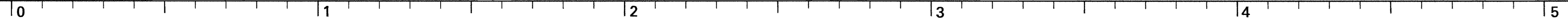

Maintenance Control Sections : Length and Description

Structure Carrying Road	Bridges (Over 20'): Length, Type, Capacity and Year Constructed		
	Vertical Clearance		
Spans Over Road	Horizontal Clearance		
	Vertical Clearance		
	Horizontal Clearance		

Right of Way Width (min.-max.) if varies
 Available Right of Way Width (Needs Study)
 Right of Way Fence: Type - Right and Left
 Control of Access: 1-None, 2-Partial, 3-Full
 Jurisdiction, Transfer Phase No. and Date (C to S or S to C) State
 Project No., Type of Construction, and Year Constructed
 Project No., Type of Construction, and Year Constructed

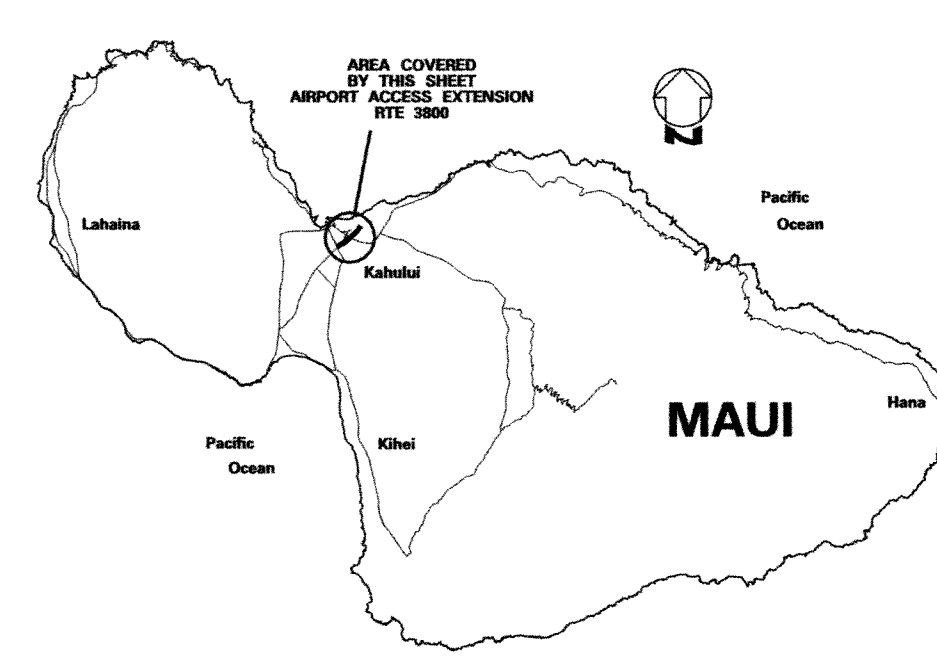

Road Diagram
* MP = Milepost Signage



SCALE: (In Miles) 4" = 1 mile

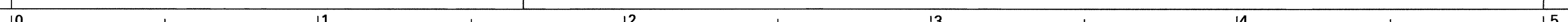

Divided Highway	Shoulder: Width and Type		
	Pavement: Width and Type		
	Shoulder: Width and Type		
	Median: Width and Type		
	Shoulder: Width and Type		
	Pavement: Width and Type		
	Shoulder: Width and Type		

Number of Traffic Lanes
 Auxiliary Lanes and Parking Lanes: No. of Lanes and Width (Left Side)
 (Right Side)
 Frontage Road: No. of Lanes, and Width (Right and Left)
 Sidewalk: Width and Type (Right and Left)
 Curb and/or Gutter: Type (Right and Left)
 Protective Devices: Type, Location and Number
 Illumination: Type, Location and Number
 Curves: Degree of Curvature (Right and Left)
 Superelevation (Range)
 Grades: % Grade, Positive or Negative
 Vertical Curve: Crest or Sag, Curve Limits
 Area and Development: Small Urban (99998)
 Terrain: 1-Flat, 2-Rolling, 3-Mountainous
 Speed: 1-Design, 2-Posted
 Intersection Control Devices: Type, Location and Cycle Timing
 Traffic Station: 874 3800 00000
 HPMS Sections - AADT
 HPMS Sections - AADT
 HPMS Sections - AADT
 DOD Sections
 Census Tracts
 Functional Classification: Principle Arterial (3)
 National Highway System (NHS): On NHS - Unbuilt
 Previous Projects: Project No., Date and Limits

SCALE: (In Miles) 4" = 1 mile



Date Released	
July 2002, DB	
Revised	
FEB, 06	D.B.
Nov, 06	D.B.
Feb, 11	D.B.
Feb, 12	D.B.
Sept, 12	E.P.J.

ROAD INVENTORY MOLOKAI RTE 450 KAMEHAMEHA V HIGHWAY

STATE OF HAWAII
DEPARTMENT OF TRANSPORTATION
HIGHWAYS DIVISION
PREPARED BY THE
HIGHWAYS PLANNING BRANCH
IN COOPERATION WITH THE
U.S. DEPARTMENT OF TRANSPORTATION
FEDERAL HIGHWAY ADMINISTRATION

Total Route Length: 27.51 miles
a. Survey Length: 27.51 miles
b. Proposed Length: 0.00 miles
c. Other Length: * 0.00 miles

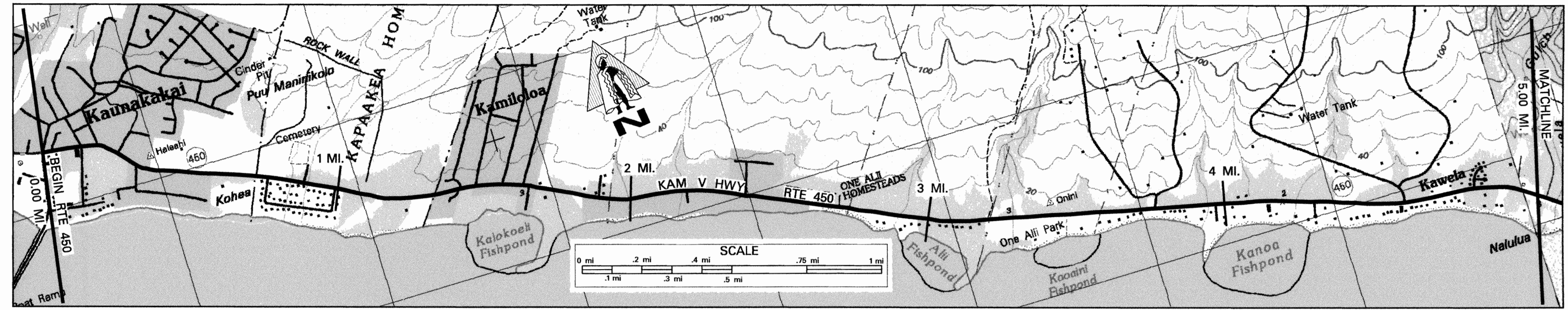

SCALE: (In Miles) 4" = 1 mile

Maintenance Control Sections : Length and Description

0.00	Begin 450A on Kam V Hwy, 84' East of the East edge of pavement of Kaunakakai Wharf Road.	450A (10.13 MI)
------	--	-----------------

Structure Carrying Road
 Bridges (Over 20'): Length, Type, Capacity and Year Constructed
 Vertical Clearance
 Horizontal Clearance
Structure Over Road
 Vertical Clearance
 Horizontal Clearance

	SLAB 1940 H15	SLAB 1940 H20
	25'	23'
	26'	26'

Right of Way Width (min.-max.) if varies
 Available Right of Way Width (Needs Study)

60' - 80'	RESIDENTIAL AREA	80'
-----------	------------------	-----

Right of Way Fence: Type - Right and Left
 Control of Access: 1-None, 2-Partial, 3-Full

	NONE	TRES AND BUSHES (FEW HOMES)
--	------	-----------------------------

Jurisdiction, Transfer Phase No. and Date (C to S or S to C)
 Project No., Type of Construction, and Year Constructed

1.00	NONE	STATE
------	------	-------

Project No., Type of Construction, and Year Constructed

0.00	450A-01-01M 2001 RESURFACE	540A-01-08M, RESURFACE, 2009
		STP-0450(6) 1996 RESURFACE

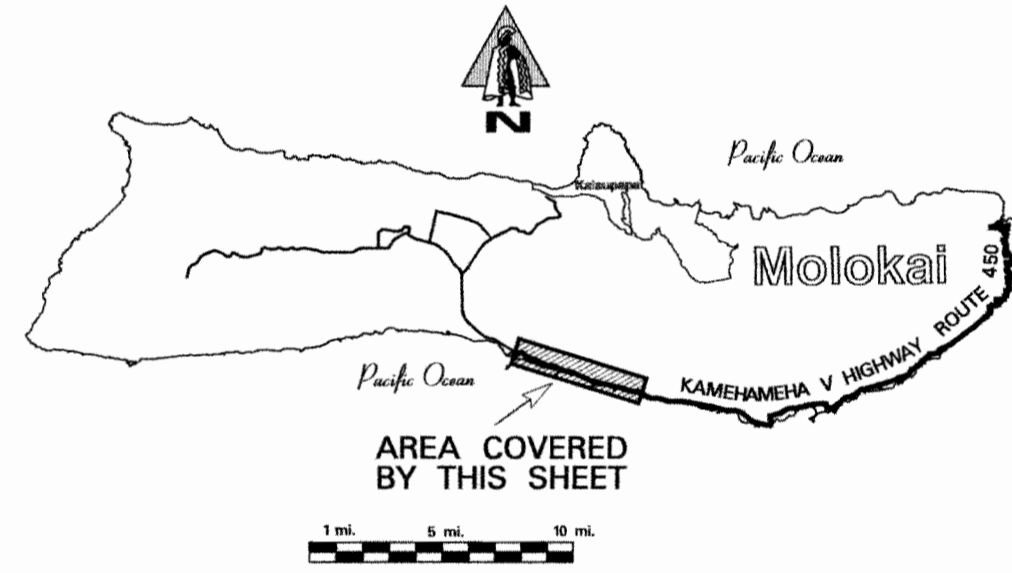

Road Diagram
 * MP = Milepost Signage

0.00 mi.	KAWAKANA PLACE	5.00 mi.
0.02 mi.	MOHALA ST.	0.02 mi.
0.12 mi.	KAMO ST.	0.12 mi.
0.18 mi.	ALOKA ST.	0.18 mi.
0.26 mi.	KAUAKAKAI SCH.	0.26 mi.
0.32 mi.	OKI PLACE	0.32 mi.
0.46 mi.	ROAD TO 'DUKE MALIU' PARK	0.46 mi.
0.69 mi.	ALANUI KAMIIKI EDUCATION CTR.	0.69 mi.
0.77 mi.	KAPA'AKEA LOOP	0.77 mi.
0.88 mi.	KAPA'AKEA CEMETERY	0.88 mi.
0.99 mi.	KAPA'AKEA LOOP	0.99 mi.
1.00 mi.	KAPA'AKEA LOOP	1.00 mi.
1.19 mi.	CULVERT	1.19 mi.
1.34 mi.	HOTEL ENT.	1.34 mi.
1.42 mi.	KAMILOLOA PLACE	1.42 mi.
1.47 mi.	A'AHU PLACE	1.47 mi.
1.53 mi.	CULVERT	1.53 mi.
1.56 mi.	ILIAHI PLACE	1.56 mi.
1.62 mi.	CULVERT	1.62 mi.
1.69 mi.	KAHINANI PLACE	1.69 mi.
1.70 mi.	OPUA PLACE	1.70 mi.
1.89 mi.	KAMILOLOA BRIDGE	1.89 mi.
1.99 mi.	OHAI ALII PLACE	1.99 mi.
2.00 mi.	KAMILOLOA BRIDGE	2.00 mi.
2.28 mi.	PANO PLACE	2.28 mi.
2.47 mi.	CULVERT	2.47 mi.
2.89 mi.	CULVERT	2.89 mi.
3.00 mi.	KAM V HWY	3.00 mi.
3.33 mi.	ONEALII PARK #1	3.33 mi.
3.76 mi.	KAWELA PLANTATION #3	3.76 mi.
3.94 mi.	MAKAKUPAIA BRIDGE	3.94 mi.
4.01 mi.	MAKAKUPAIA BRIDGE	4.01 mi.
4.30 mi.	HOOUU PL.	4.30 mi.
4.59 mi.	PAVED ROAD	4.59 mi.
4.66 mi.	CULVERT	4.66 mi.
4.84 mi.	KAWAKANA PLACE	4.84 mi.
5.00 mi.	KAWAKANA PLACE	5.00 mi.

CONTINUES ON SHEET #2

SCALE: (In Miles) 4" = 1 mile

Divided Highway
 Undivided
 Shoulder: Width and Type
 Pavement: Width and Type
 Shoulder: Width and Type
 Median: Width and Type
 Shoulder: Width and Type
 Pavement: Width and Type
 Shoulder: Width and Type

6' AC	24' AC	4' AC
0.28	6' AC	22' AC
12' AC		4' AC

Number of Traffic Lanes
 Auxiliary Lanes and Parking Lanes: No. of Lanes and Width (Left Side)
 (Right Side)

2 - 12'	NONE	2 - 11'
---------	------	---------

Frontage Road: No. of Lanes, and Width (Right and Left)
 Sidewalk: Width and Type (Right and Left)
 Curb and/or Gutter: Type (Right and Left)

6' BP	NONE	NONE
-------	------	------

Protective Devices: Type, Location and Number
 Illumination: Type, Location and Number

MERCURY VAPOR	MERCURY VAPOR	1 MV
---------------	---------------	------

Curves: Degree of Curvature (Right and Left)
 Superelevation (Range)

0.43	0	0.28
------	---	------

Grades: % Grade, Positive or Negative
 Vertical Curve: Crest or Sag, Curve Limits

0.43	0	0.28
------	---	------

Area and Development:
 Terrain: 1-Flat, 2-Rolling, 3-Mountainous

35 MPH (2)	FLAT (1)	35 MPH (2)
------------	----------	------------

Speed: 1-Design, 2-Posted
 Intersection Control Devices: Type, Location and Cycle Timing

NOT POSTED	35 MPH (2)	35 MPH (2)
------------	------------	------------

Traffic Stations (Current Year)
 HPMS Sections - AADT 2011
 HPMS Sections - AADT 2010
 HPMS Sections - AADT 2009

875 0450 00000	875 0450 00134	875 0450 00189
7,200	4,985	2,500
6,800	4,715	3,000
5,700	4,668	2,700

DOD Sections
 Census Tracts
 Functional Classification

MAJOR COLLECTOR (5)	NOT ON NHS (0)	MAJOR COLLECTOR (5)
---------------------	----------------	---------------------

National Highway System (NHS)
 Previous Projects: Project No., Date and Limits

HWY-M-06-98M 1997	STP-0450(7) 1996	HWY-M-02-90 1991 SHOULDER IMPROVEMENT
-------------------	------------------	---------------------------------------

County

0.51	1.00	1.90
------	------	------

SCALE: (In Miles) 4" = 1 mile

0	1	2
---	---	---

Date Released	Revised
Oct 2004 GN	
Nov. 06 D.B.	
Dec. 09 D.B.	
Feb. 11 D.B.	
Feb. 12 D.B.	
Sept. 12 E.P.J.	

**ROAD INVENTORY
MOLOKAI RTE 450
KAMEHAMEHA V HIGHWAY**

STATE OF HAWAII
DEPARTMENT OF TRANSPORTATION
HIGHWAYS DIVISION

PREPARED BY THE
HIGHWAYS PLANNING BRANCH
IN COOPERATION WITH THE
U.S. DEPARTMENT OF TRANSPORTATION
FEDERAL HIGHWAY ADMINISTRATION

Total Route Length: 27.51 miles
a. Survey Length: 27.51 miles
b. Proposed Length: 0.00 miles
c. Other Length: * 0.00 miles

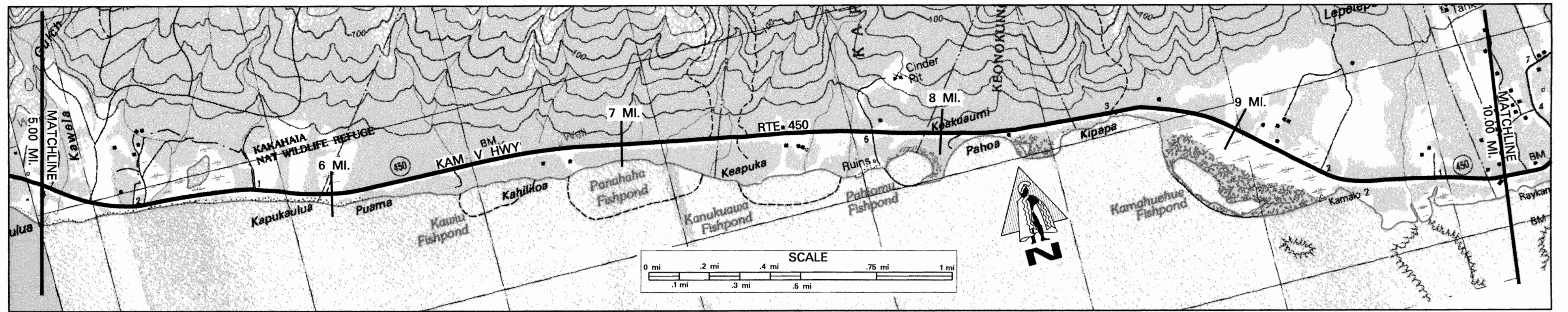

SCALE: (In Miles) 4" = 1 mile

Maintenance Control Sections : Length and Description		5	6	7	8	9	10
		450A (10.13 MI)					

Structure Carrying Road	Bridges (Over 20'): Length, Type, Capacity and Year Constructed		SLAB 1940 H15 46'						PRESTRESSED CONCRETE SLAB 1981 HS-20-44 43'	
	Vertical Clearance									
Structure Over Road	Horizontal Clearance		28'							28'
	Vertical Clearance									

Right of Way Width (min.-max.) if varies		NONE		NONE		NONE		NONE	
Available Right of Way Width (Needs Study)		NONE		NONE		NONE		NONE	
Right of Way Fence: Type - Right and Left		NONE		NONE		NONE		NONE	
Control of Access: 1-None, 2-Partial, 3-Full		NONE		NONE		NONE		NONE	
Jurisdiction, Transfer Phase No. and Date (C to S or S to C)		NONE		NONE		NONE		NONE	
Project No., Type of Construction, and Year Constructed		STP-0450(6) 1996 RESURFACE		STP-0450(7) 1998 RESURFACE		450AB-01-01M 2001 RESURFACE			
Project No., Type of Construction, and Year Constructed									

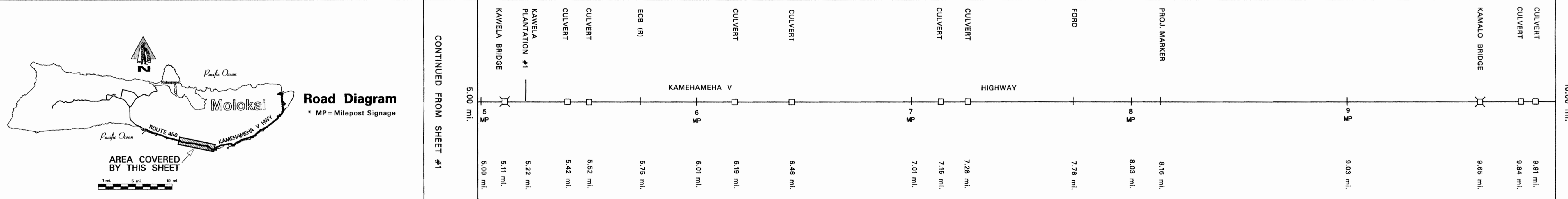

SCALE: (In Miles) 4" = 1 mile

Divided Highway	Shoulder: Width and Type		GRASS UNLESS NOTED								
	Pavement: Width and Type		4' AC		22' AC		20' AC		20' DIRT		10'
	Shoulder: Width and Type		GRASS UNLESS NOTED		4' AC		20'		10' DIRT		8' 6" DIRT 6' DIRT 4' 10'

Median: Width and Type												
Shoulder: Width and Type												
Pavement: Width and Type												
Shoulder: Width and Type												
Number of Traffic Lanes		2 - 11'				2 - 10'						
Auxiliary Lanes and Parking Lanes: No. of Lanes and Width (Left Side) (Right Side)		NONE										
Frontage Road: No. of Lanes, and Width (Right and Left)		NONE										
Sidewalk: Width and Type (Right and Left)												
Curb and/or Gutter: Type (Right and Left)												
Protective Devices: Type, Location and Number		ALL GUARDRAILS METAL ON METAL										
Illumination: Type, Location and Number												
Curves: Degree of Curvature (Right and Left)												
Superelevation (Range)												
Grades: % Grade, Positive or Negative		0 6.49 -1 6.89										
Vertical Curve: Crest or Sag, Curve Limits												
Area and Development:												
Terrain: 1-Flat, 2-Rolling, 3-Mountainous		FLAT (1) 6.44 ROLLING (2) FLAT (3) 6.77										
Speed: 1-Design, 2-Posted		FLAT (1) 35 MPH (2) 45 MPH (MIN. 35 MPH) (2)										
Intersection Control Devices: Type, Location and Cycle Timing		35 MPH (2) 45 MPH (MIN. 35 MPH) (2)										

Traffic Stations (Current Year)		B75 0450 00189		B75 0450 00522		B75 0450 00784					
HPMS Sections - AADT 2011		2,500		1,300		1,300					
HPMS Sections - AADT 2010		3,000		1,300		1,200					
HPMS Sections - AADT 2009		2,700		1,300		1,100					
DOD Sections											
Census Tracts											
Functional Classification		MAJOR COLLECTOR (5)									
National Highway System (NHS)		NOT ON NHS (0)									
Previous Projects: Project No., Date and Limits		RS-0450(1) 1979 RESURFACE; FAS 2A 1940; RS-0450(7) 1998 RESURFACE; 450AB-01-89M 1990 RESURFACE; S-2(2); 450AB-01-76M 1976 RESURFACE; COUNTY									

SCALE: (In Miles) 4" = 1 mile

Date Released	
04/04/04	GN
Revised	
Aug. 06	D.B.
Feb. 11	D.B.
Feb. 12	D.B.
Sept. 12	E.P.J.

ROAD INVENTORY MOLOKAI RTE 450 KAMEHAMEHA V HIGHWAY

STATE OF HAWAII
DEPARTMENT OF TRANSPORTATION
HIGHWAYS DIVISION
PREPARED BY THE
HIGHWAYS PLANNING BRANCH
IN COOPERATION WITH THE
U.S. DEPARTMENT OF TRANSPORTATION
FEDERAL HIGHWAY ADMINISTRATION

Total Route Length: 27.51 miles
a. Survey Length: 27.51 miles
b. Proposed Length: 0.00 miles
c. Other Length: * 0.00 miles

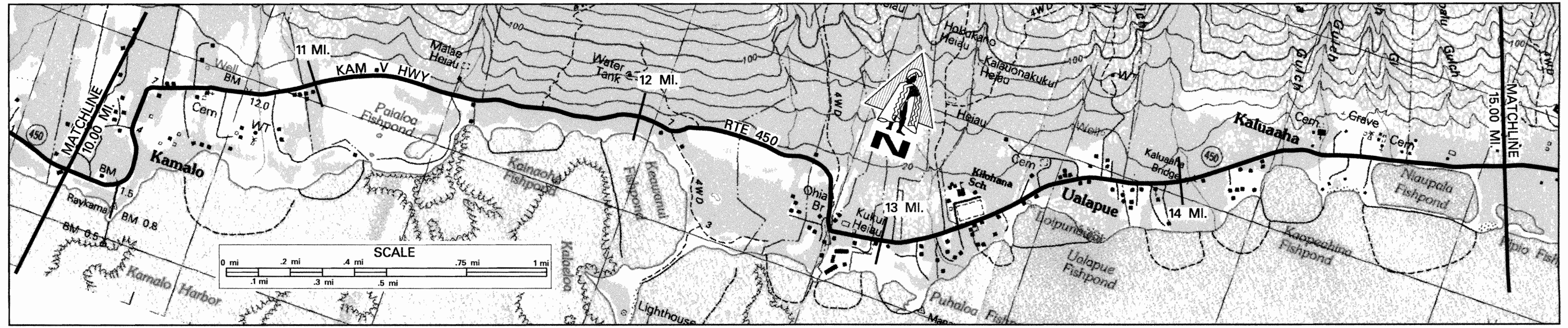

SCALE: (In Miles) 4" = 1 mile

Maintenance Control Sections : Length and Description

BEGIN 450 B SAME AS BEGIN SR 450 450B (17.43 MI.)

Structure Carrying Road
 Bridges (Over 20'): Length, Type, Capacity and Year Constructed
 Vertical Clearance
 Horizontal Clearance
Structure Over Road
 Vertical Clearance
 Horizontal Clearance

PRE-STRESSED SLAB 22' 1979 HS-20
 PRE-STRESSED SLAB 36' 1979 HS-20
 18'
 21'

Right of Way Width (min.-max.) if varies
 Available Right of Way Width (Needs Study)
 Right of Way Fence: Type - Right and Left
 Control of Access: 1-None, 2-Partial, 3-Full
 Jurisdiction, Transfer Phase No. and Date (C to S or S to C)
 Project No., Type of Construction, and Year Constructed
 Project No., Type of Construction, and Year Constructed

80'
 TREES AND LARGE BUSHES W / SOME HOMES AND OPEN PASTURE
 WIRE ON METAL CHAIN LINK
 NONE
 STATE
 450AB-01-01M RESURFACE 2001
 450B-01-02M RESURFACE 2003

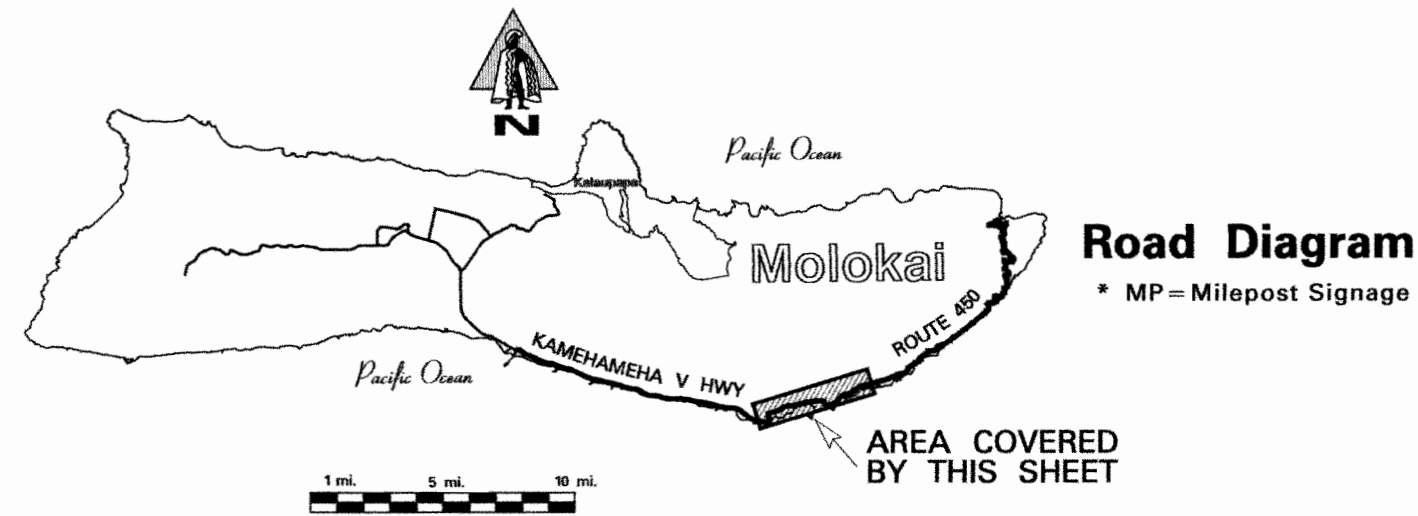

CONTINUED FROM SHEET #2

KAMALO WHARF ROAD	FORD	CULVERT	CULVERT	OHA BRIDGE	ROAD TO WAVEREST RESORTS HAWAII TEL. SUBSTATION	FORD	KILOHANA SCHOOL	UALAPUE PLACE	KALUAHA BRIDGE	KEALANUI OHINA PL.				
9.4	10.02	10.15	10.84	11.02	12.03	12.12	12.52	12.81	13.01	13.17	13.26	13.43	14.02	14.15

CONTINUES ON SHEET #4

SCALE: (In Miles) 4" = 1 mile

Unimproved
 Shoulder: Width and Type
 Pavement: Width and Type
 Shoulder: Width and Type
Divided Highway
 Median: Width and Type
 Shoulder: Width and Type
 Pavement: Width and Type
 Shoulder: Width and Type

10'	6' - 8'	4'	6'	8'	6'	2' - 4' AC	4' AC / 2' GRASS	2' - 4' AC
20' AC	10' - 12'	10' - 12'	10' - 12'	10' - 12'	10' - 12'	18' AC		

Number of Traffic Lanes
 Auxiliary Lanes and Parking Lanes: No. of Lanes and Width (Left Side)
 (Right Side)
 Frontage Road: No. of Lanes, and Width (Right and Left)
 Sidewalk: Width and Type (Right and Left)
 Curb and/or Gutter: Type (Right and Left)

2-10'						2 - 9'	NONE	NONE	NONE	NONE
-------	--	--	--	--	--	--------	------	------	------	------

Protective Devices: Type, Location and Number
 Illumination: Type, Location and Number
 Curves: Degree of Curvature (Right and Left)
 Superelevation (Range)
 Grades: % Grade, Positive or Negative
 Vertical Curve: Crest or Sag, Curve Limits
 Area and Development:
 Terrain: 1-Flat, 2-Rolling, 3-Mountainous
 Speed: 1-Design, 2-Posted
 Intersection Control Devices: Type, Location and Cycle Timing

1 INCA						METAL ON METAL	METAL ON METAL
35 MPH (1)	35 MPH (2)	30 MPH (2)	20 MPH (SCHOOL ZONE)	20 MPH (SCHOOL ZONE)	30 MPH (2)		

Traffic Stations (Current Year)
 HPMS Sections - AADT 2011
 HPMS Sections - AADT 2010
 HPMS Sections - AADT 2009
 DOD Sections
 Census Tracts
 Functional Classification
 National Highway System (NHS)
 Previous Projects: Project No., Date and Limits

B75 0450 00784	B75 0450 01133	B75 0450 01447
1,300	1,253	1,026
1,200	1,185	971
1,100	1,173	961
450AB-01-01M 2001 RESURFACE	HWY-M-01-96M 1997	450B-01-94M 1996 RESURFACE
450AB-01-89 1990 RESURFACE	450B-02-88 1988 SHOULDER IMPROVEMENTS	14.03 14.05 14.07
450AB-01-76M 1976 RESURFACE	450B-01-76M 1976 RESURFACE	14.03 14.07 14.09

SCALE: (In Miles) 4" = 1 mile

Date Released
 Oct 2004 GN

Revised
 Nov. 06 D.B.
 Dec. 09 D.B.
 Feb. 11 D.B.
 Feb. 12 D.B.
 Sept. 12 E.P.J.

ROAD INVENTORY

MOLOKAI RTE 450 KAMEHAMEHA V HIGHWAY

STATE OF HAWAII
DEPARTMENT OF TRANSPORTATION
HIGHWAYS DIVISION

PREPARED BY THE
HIGHWAYS PLANNING BRANCH
IN COOPERATION WITH THE
U.S. DEPARTMENT OF TRANSPORTATION
FEDERAL HIGHWAY ADMINISTRATION

Total Route Length: 27.51 miles

a. Survey Length: 27.51 miles

b. Proposed Length: 0.00 miles

c. Other Length: * 0.00 miles

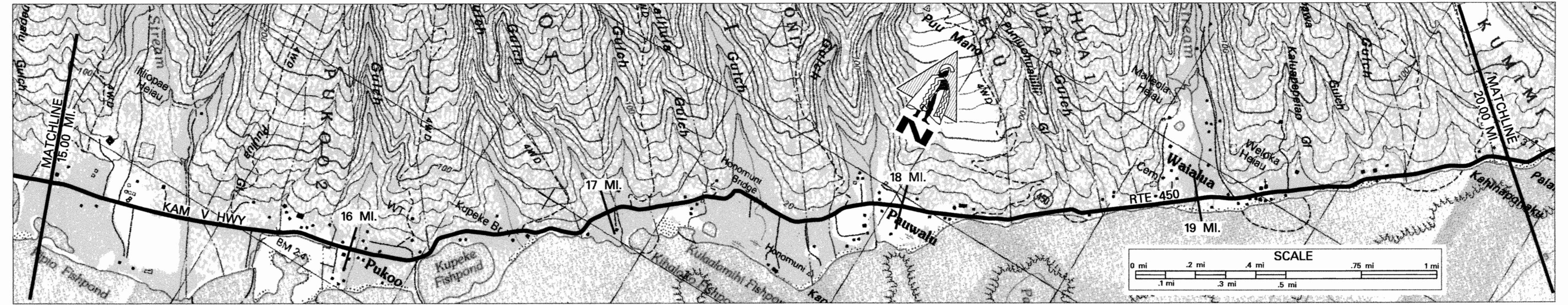

SCALE: (In Miles) 4" = 1 mile

Maintenance Control Sections : Length and Description	15	16	17	18	19	20							
Structure Carrying Road	450 B (17.43 MI.)												
Bridges (Over 20'): Length, Type, Capacity and Year Constructed	<table style="width: 100%; border-collapse: collapse;"> <tr> <td style="width: 16.6%;">SLAB 1950 (1968) HS20</td> <td style="width: 16.6%;">PRESTRESSED BEAM 25' 1979 HS20</td> <td style="width: 16.6%;">PRESTRESSED BEAM 16' 1979 HS20</td> <td style="width: 16.6%;">PRESTRESSED CONC. GIRDER 2007, HL-93 64'-2"</td> <td style="width: 16.6%;">PRESTRESSED BEAM 103' 1979 HS20</td> <td colspan="2"></td> </tr> </table>						SLAB 1950 (1968) HS20	PRESTRESSED BEAM 25' 1979 HS20	PRESTRESSED BEAM 16' 1979 HS20	PRESTRESSED CONC. GIRDER 2007, HL-93 64'-2"	PRESTRESSED BEAM 103' 1979 HS20		
SLAB 1950 (1968) HS20	PRESTRESSED BEAM 25' 1979 HS20	PRESTRESSED BEAM 16' 1979 HS20	PRESTRESSED CONC. GIRDER 2007, HL-93 64'-2"	PRESTRESSED BEAM 103' 1979 HS20									
Vertical Clearance													
Horizontal Clearance													
Vertical Clearance	20'												
Horizontal Clearance	21'												
Right of Way Width (min.-max.) if varies	80'												
Available Right of Way Width (Needs Study)	TREES AND LARGE BUSHES W/ SOME HOMES AND OPEN PASTURE												
Right of Way Fence: Type - Right and Left	WIRE ON METAL W I R E												
Control of Access: 1-None, 2-Partial, 3-Full	N O N E												
Jurisdiction, Transfer Phase No. and Date (C to S or S to C)	S T A T E												
Project No., Type of Construction, and Year Constructed	<table style="width: 100%; border-collapse: collapse;"> <tr> <td style="width: 16.6%;">450B-01-02M RESURFACE 2003</td> <td style="width: 16.6%;">450B-01-03M, RESURFACE, 2006</td> <td style="width: 16.6%;">450B-01-94M RESURFACE 1996</td> <td style="width: 16.6%;">(ER-12(4), BRIDGE REPLACEMENT, 2007)</td> <td style="width: 16.6%;">450B-01-03M, RESURFACE, 2006</td> <td colspan="2"></td> </tr> </table>						450B-01-02M RESURFACE 2003	450B-01-03M, RESURFACE, 2006	450B-01-94M RESURFACE 1996	(ER-12(4), BRIDGE REPLACEMENT, 2007)	450B-01-03M, RESURFACE, 2006		
450B-01-02M RESURFACE 2003	450B-01-03M, RESURFACE, 2006	450B-01-94M RESURFACE 1996	(ER-12(4), BRIDGE REPLACEMENT, 2007)	450B-01-03M, RESURFACE, 2006									
Project No., Type of Construction, and Year Constructed	<table style="width: 100%; border-collapse: collapse;"> <tr> <td style="width: 16.6%;">2003</td> <td style="width: 16.6%;">2006</td> <td style="width: 16.6%;">1996</td> <td style="width: 16.6%;">2007</td> <td style="width: 16.6%;">1994</td> <td style="width: 16.6%;">COUNTY</td> <td style="width: 16.6%;">450B-01-88M 1988 (R)</td> </tr> </table>						2003	2006	1996	2007	1994	COUNTY	450B-01-88M 1988 (R)
2003	2006	1996	2007	1994	COUNTY	450B-01-88M 1988 (R)							

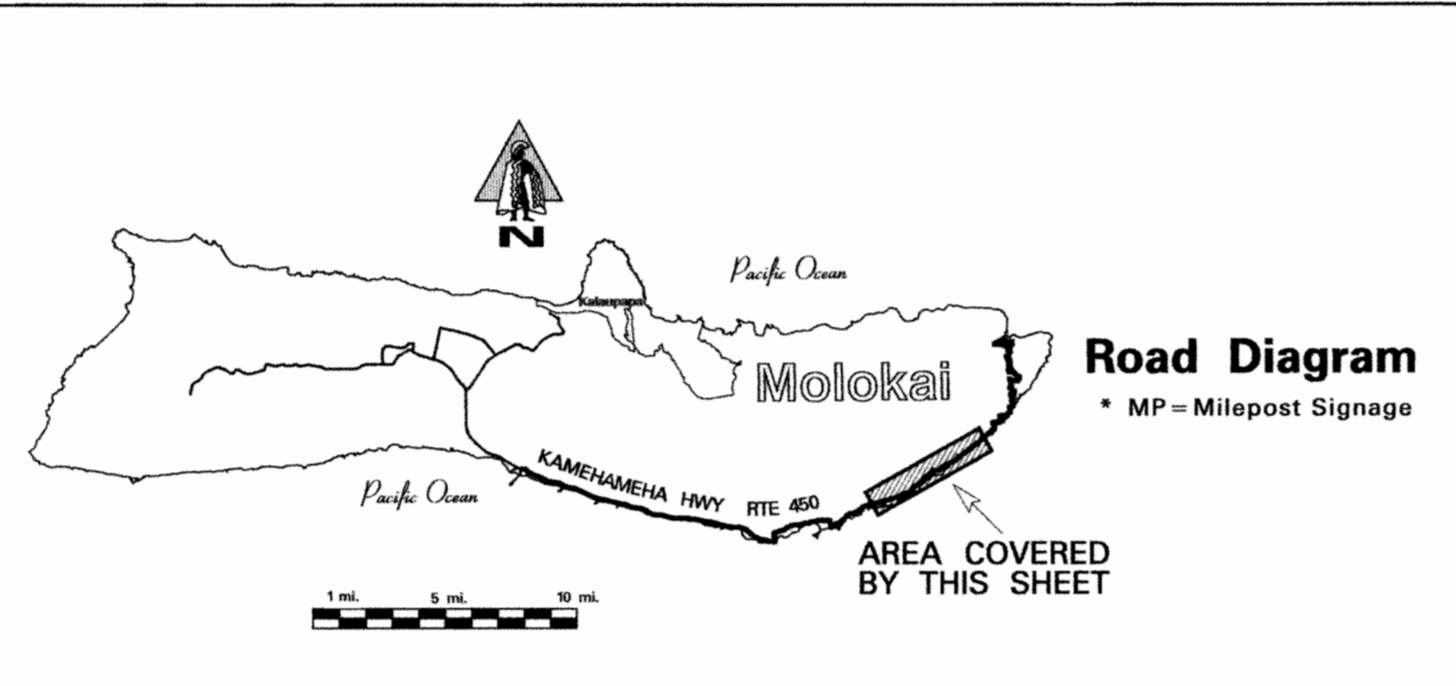

SCALE: (In Miles) 4" = 1 mile

Divided Highway	15	16	17	18	19	20						
Shoulder: Width and Type	2' - 4' AC											
Pavement: Width and Type	18' AC											
Shoulder: Width and Type	2' - 4' AC											
Median: Width and Type	16' AC											
Shoulder: Width and Type	6' GRASS											
Pavement: Width and Type	14' BST											
Shoulder: Width and Type	6' - 8' GRASS											
Shoulder: Width and Type	14' BP											
Shoulder: Width and Type	14' - 18' AC											
Shoulder: Width and Type	2' - 6' AC											
Number of Traffic Lanes	2 - 9'											
Auxiliary Lanes and Parking Lanes: No. of Lanes and Width (Left Side)	2 - 7'											
Auxiliary Lanes and Parking Lanes: No. of Lanes and Width (Right Side)	N O N E											
Frontage Road: No. of Lanes, and Width (Right and Left)	N O N E											
Sidewalk: Width and Type (Right and Left)	N O N E											
Curb and/or Gutter: Type (Right and Left)	N O N E											
Protective Devices: Type, Location and Number	METAL ON METAL											
Illumination: Type, Location and Number												
Curves: Degree of Curvature (Right and Left)												
Superelevation (Range)												
Grades: % Grade, Positive or Negative												
Vertical Curve: Crest or Sag, Curve Limits												
Area and Development:	RURAL (99999)											
Terrain: 1-Flat, 2-Rolling, 3-Mountainous	FLAT (1)											
Speed: 1-Design, 2-Posted	30 MPH (2)											
Intersection Control Devices: Type, Location and Cycle Timing												
Traffic Stations (Current Year)	<table style="width: 100%; border-collapse: collapse;"> <tr> <td style="width: 16.6%;">B75 0450 01447</td> <td style="width: 16.6%;">B75 0450 01665</td> <td style="width: 16.6%;">B75 0450 01862</td> <td style="width: 16.6%;">B75 0450 01966</td> <td colspan="2"></td> </tr> </table>						B75 0450 01447	B75 0450 01665	B75 0450 01862	B75 0450 01966		
B75 0450 01447	B75 0450 01665	B75 0450 01862	B75 0450 01966									
HPMS Sections - AADT 2011	1,026											
HPMS Sections - AADT 2010	971											
HPMS Sections - AADT 2009	961											
DOD Sections												
Census Tracts												
Functional Classification	MAJOR COLLECTOR (5)											
National Highway System (NHS)	NOT ON NHS (0)											
Previous Projects: Project No., Date and Limits	<table style="width: 100%; border-collapse: collapse;"> <tr> <td style="width: 16.6%;">450B-01-80M 1980 RESURFACE</td> <td style="width: 16.6%;">450B-01-94M 1996 RESURFACE</td> <td style="width: 16.6%;">450B-01-03M, RESURFACE, 2006</td> <td style="width: 16.6%;">STP-0450(5) 1994 GUARDRAIL AND SHOULDER IMPROVEMENTS</td> <td style="width: 16.6%;">450B-01-81M 1981 RESURFACE</td> <td style="width: 16.6%;">450B-01-87M 1987 RESURFACE</td> </tr> </table>						450B-01-80M 1980 RESURFACE	450B-01-94M 1996 RESURFACE	450B-01-03M, RESURFACE, 2006	STP-0450(5) 1994 GUARDRAIL AND SHOULDER IMPROVEMENTS	450B-01-81M 1981 RESURFACE	450B-01-87M 1987 RESURFACE
450B-01-80M 1980 RESURFACE	450B-01-94M 1996 RESURFACE	450B-01-03M, RESURFACE, 2006	STP-0450(5) 1994 GUARDRAIL AND SHOULDER IMPROVEMENTS	450B-01-81M 1981 RESURFACE	450B-01-87M 1987 RESURFACE							

SCALE: (In Miles) 4" = 1 mile

Date Released	Revised
Oct 2004 G.N.	
Nov., 06 D.B.	
Feb., 08 D.B.	
Feb., 11 D.B.	
Feb., 12 D.B.	
Sept. 12 E.P.J.	

ROAD INVENTORY MOLOKAI RTE 450 KAMEHAMEHA V HWY

STATE OF HAWAII
DEPARTMENT OF TRANSPORTATION
HIGHWAYS DIVISION
PREPARED BY THE
HIGHWAYS PLANNING BRANCH
IN COOPERATION WITH THE
U.S. DEPARTMENT OF TRANSPORTATION
FEDERAL HIGHWAY ADMINISTRATION

Total Route Length: 27.51 miles
a. Survey Length: 27.51 miles
b. Proposed Length: 0.00 miles
c. Other Length: * 0.00 miles

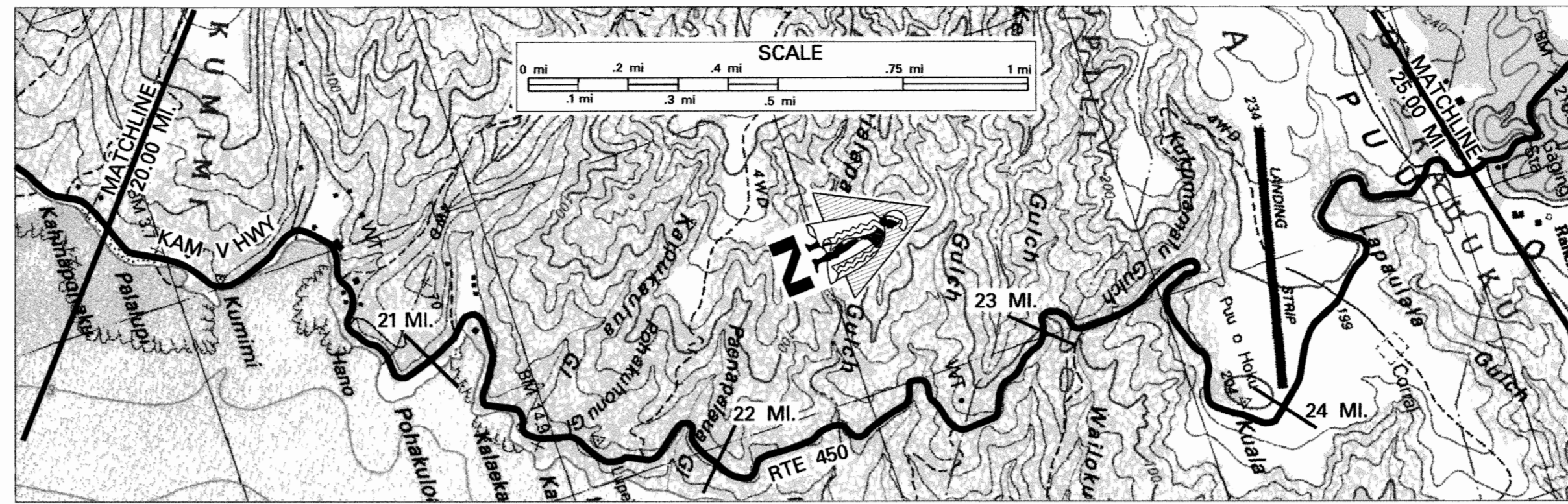

SCALE: (In Miles) 4" = 1 mile

Maintenance Control Sections : Length and Description		450B (17.43 MI.)
Structure Carrying Road	Bridges (Over 20'): Length, Type, Capacity and Year Constructed	CULVERT 1960 HS20 TIMBER STRINGER 2008, HS-20
	Vertical Clearance	
	Horizontal Clearance	12' 13'
	Vertical Clearance	
	Horizontal Clearance	
Right of Way Width (min.-max.) if varies		80'
Available Right of Way Width (Needs Study)		TREES BUSHES AND SOME OPEN PASTURE
Right of Way Fence: Type - Right and Left		WOOD POST W/WIRE 10'-15' FROM PAVEMENT
Control of Access: 1-None, 2-Partial, 3-Full		NONE
Jurisdiction, Transfer Phase No. and Date (C to S or S to C)		STATE
Project No., Type of Construction, and Year Constructed		(450B-01-05M, Bridge Replacement, 2008)
Project No., Type of Construction, and Year Constructed		450B-01-03M, RESURFACE, 2006 450B-01-05M, Resurface, 2008 450B-01-88M RESURFACE 1988 (450B-01-92M (R) 1993)
<p style="text-align: center;">Road Diagram * MP = Milepost Signage AREA COVERED BY THIS SHEET</p>		<p style="writing-mode: vertical-rl; transform: rotate(180deg);">CONTINUED FROM SHEET #4</p> <p style="writing-mode: vertical-rl; transform: rotate(180deg);">CONTINUES ON SHEET #6</p>

SCALE: (In Miles) 4" = 1 mile

Divided Highway	Shoulder: Width and Type	2' - 6' AC
	Pavement: Width and Type	14' - 18' AC
	Shoulder: Width and Type	2' - 6' AC
	Median: Width and Type	
	Shoulder: Width and Type	
Number of Traffic Lanes		2 - (7' - 9')
Auxiliary Lanes and Parking Lanes: No. of Lanes and Width (Left Side)		NONE
(Right Side)		NONE
Frontage Road: No. of Lanes, and Width (Right and Left)		
Sidewalk: Width and Type (Right and Left)		NONE
Curb and/or Gutter: Type (Right and Left)		NONE
Protective Devices: Type, Location and Number		PORTABLE CONC. BARRIER M/M R/T
Illumination: Type, Location and Number		NONE
Curves: Degree of Curvature (Right and Left)		
Superelevation (Range)		
Grades: % Grade, Positive or Negative		
Vertical Curve: Crest or Sag, Curve Limits		
Area and Development:		RURAL (99999)
Terrain: 1-Flat, 2-Rolling, 3-Mountainous		ROLLING (2) MOUNTAINOUS (3) MOUNTAINOUS (3)
Speed: 1-Design, 2-Posted		10 MPH (1) 20 MPH (2)
Intersection Control Devices: Type, Location and Cycle Timing		
Traffic Stations (Current Year)		875 0450 01966
HPMS Sections - AADT 2011		396
HPMS Sections - AADT 2010		382
HPMS Sections - AADT 2009		388
DOD Sections		
Census Tracts		
Functional Classification		MAJOR COLLECTOR (5)
National Highway System (NHS)		NOT ON NHS (0)
Previous Projects: Project No., Date and Limits		450B-01-88M RESURFACE 1988 450B-01-87M 1987 RESURFACE

SCALE: (In Miles) 4" = 1 mile

Date Released	Revised
Oct 2004 G.N	
Nov., 06 D.B.	
Mar., 09 D.B.	
Feb. 11 D.B.	
Feb. 12 D.B.	
Sept. 12 E.P.J.	

ROAD INVENTORY MOLOKAI RTE 450 KAMEHAMEHA V HWY.

STATE OF HAWAII
DEPARTMENT OF TRANSPORTATION
HIGHWAYS DIVISION

PREPARED BY THE
HIGHWAYS PLANNING BRANCH
IN COOPERATION WITH THE
U.S. DEPARTMENT OF TRANSPORTATION
FEDERAL HIGHWAY ADMINISTRATION

Total Route Length: 27.51 miles
a. Survey Length: 27.51 miles
b. Proposed Length: 0.00 miles
c. Other Length: * 0.00 miles

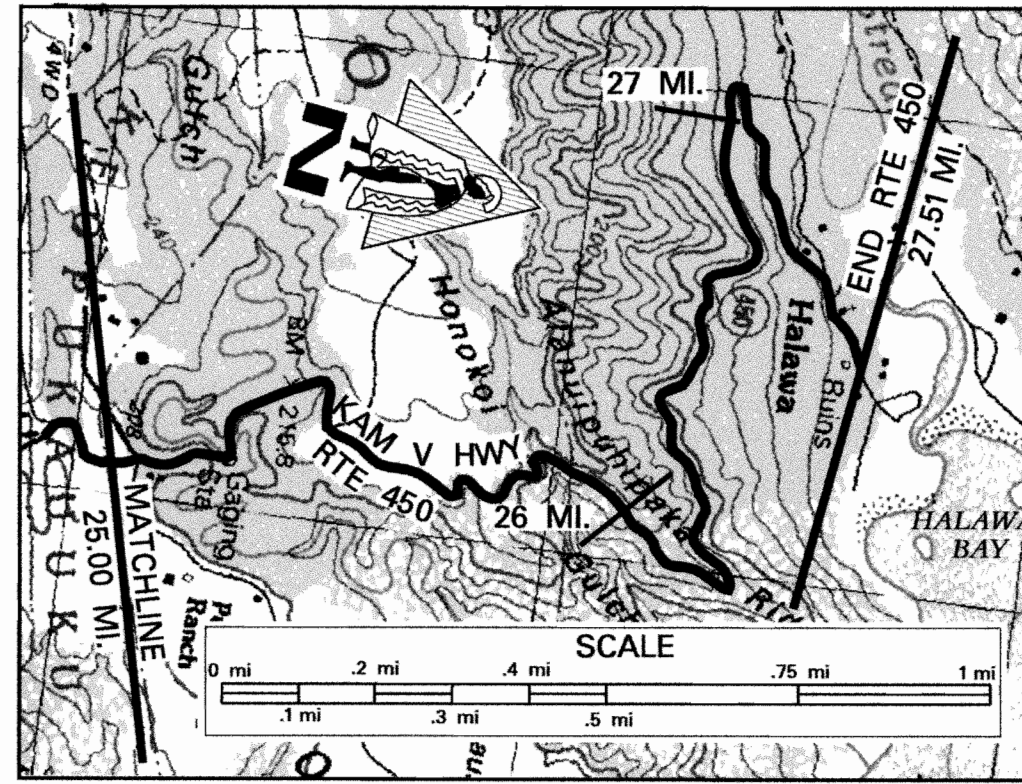

SCALE: (In Miles) 4" = 1 mile

Maintenance Control Sections : Length and Description

450 B (17.43 MI.)

Structure Carrying Road
 Bridges (Over 20'): Length, Type, Capacity and Year Constructed
 Vertical Clearance
 Horizontal Clearance
Structure Over Road
 Vertical Clearance
 Horizontal Clearance

CULVERT

Right of Way Width (min.-max.) if varies

Available Right of Way Width (Needs Study)

Right of Way Fence: Type - Right and Left

Control of Access: 1-None, 2-Partial, 3-Full

Jurisdiction, Transfer Phase No. and Date (C to S or S to C)

Project No., Type of Construction, and Year Constructed

Project No., Type of Construction, and Year Constructed

WOOD ON WIRE 10'-15' FROM PAVEMENT 25.25
 WOOD ON WIRE 10'-15' FROM PAVEMENT 26.25

NONE
STATE

450-01-05M, Resurf., 2008

450B-01-92M RESURFACE 1993

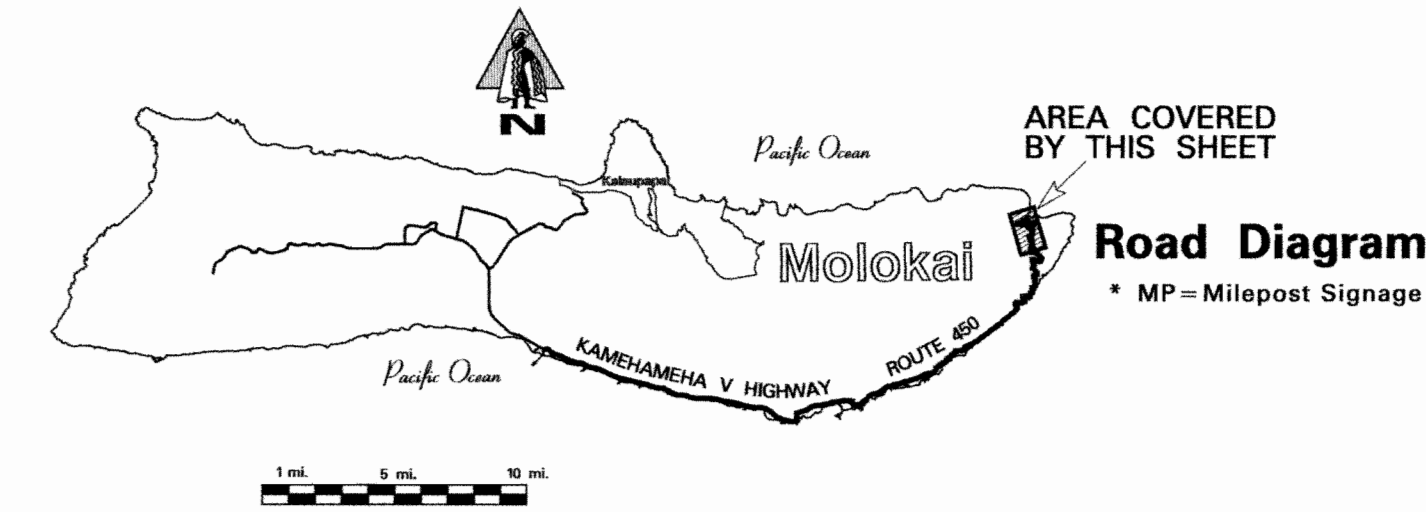

SCALE: (In Miles) 4" = 1 mile

CONTINUED FROM SHEET #5

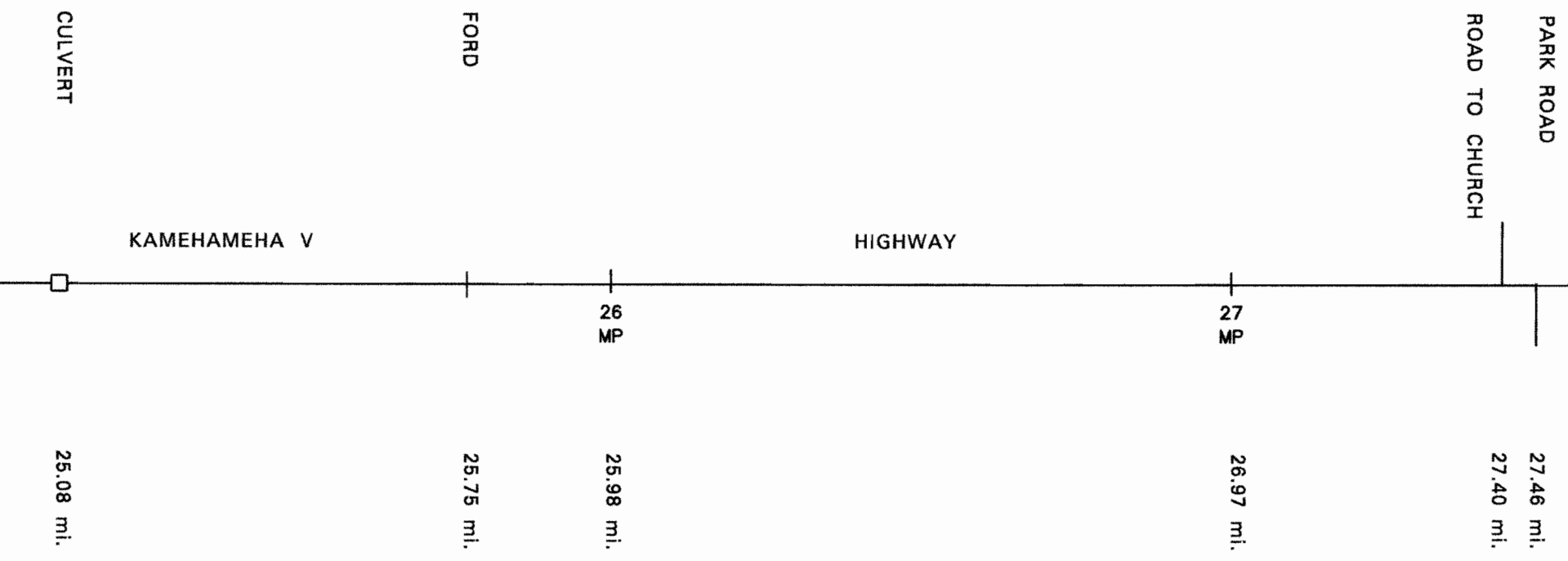

END ROUTE 450 ON KAMEHAMEHA V HIGHWAY AT THE END OF PAVEMENT.

Undivided Highway
 Shoulder: Width and Type
 Pavement: Width and Type
 Shoulder: Width and Type
Divided Highway
 Median: Width and Type
 Shoulder: Width and Type
 Pavement: Width and Type
 Shoulder: Width and Type

2' AC
14' AC
2' AC

Number of Traffic Lanes

2 - 7'

Auxiliary Lanes and Parking Lanes: No. of Lanes and Width (Left Side)
(Right Side)

NONE
NONE

Frontage Road: No. of Lanes, and Width (Right and Left)

Sidewalk: Width and Type (Right and Left)

Curb and/or Gutter: Type (Right and Left)

NONE
NONE

Protective Devices: Type, Location and Number

Illumination: Type, Location and Number

Curves: Degree of Curvature (Right and Left)

Superelevation (Range)

Grades: % Grade, Positive or Negative

Vertical Curve: Crest or Sag, Curve Limits

Area and Development:

RURAL (99999)

Terrain: 1-Flat, 2-Rolling, 3-Mountainous

MOUNTAINOUS (3) ROLLING (2)

Speed: 1-Design, 2-Posted

20 MPH (2)

SPEED NOT POSTED

Intersection Control Devices: Type, Location and Cycle Timing

Traffic Stations (Current Year)

B75 0450 02494

HPMS Sections - AADT 2011

102

HPMS Sections - AADT 2010

101

HPMS Sections - AADT 2009

100

DOD Sections

Census Tracts

Functional Classification

MAJOR COLLECTOR (5)

National Highway System (NHS)

NOT ON NHS (0)

Previous Projects: Project No., Date and Limits

COUNTY

SCALE: (In Miles) 4" = 1 mile

Date Released	Revised
Oct 2004 GN	
Nov, 06	D.B.
Feb, 09	D.B.
Feb, 11	D.B.
Feb, 12	D.B.
Sept, 12	E.P.J.

ROAD INVENTORY

MOLOKAI RTE 460

KAUNAKAKAI PLACE AND MAUNALO A HIGHWAY

STATE OF HAWAII
DEPARTMENT OF TRANSPORTATION
HIGHWAYS DIVISION
PREPARED BY THE
HIGHWAYS PLANNING BRANCH
IN COOPERATION WITH THE
U.S. DEPARTMENT OF TRANSPORTATION
FEDERAL HIGHWAY ADMINISTRATION

Total Route Length: 16.56 miles
a. Survey Length: 16.56 miles
b. Proposed Length: 0.00 miles
c. Other Length: * 0.00 miles

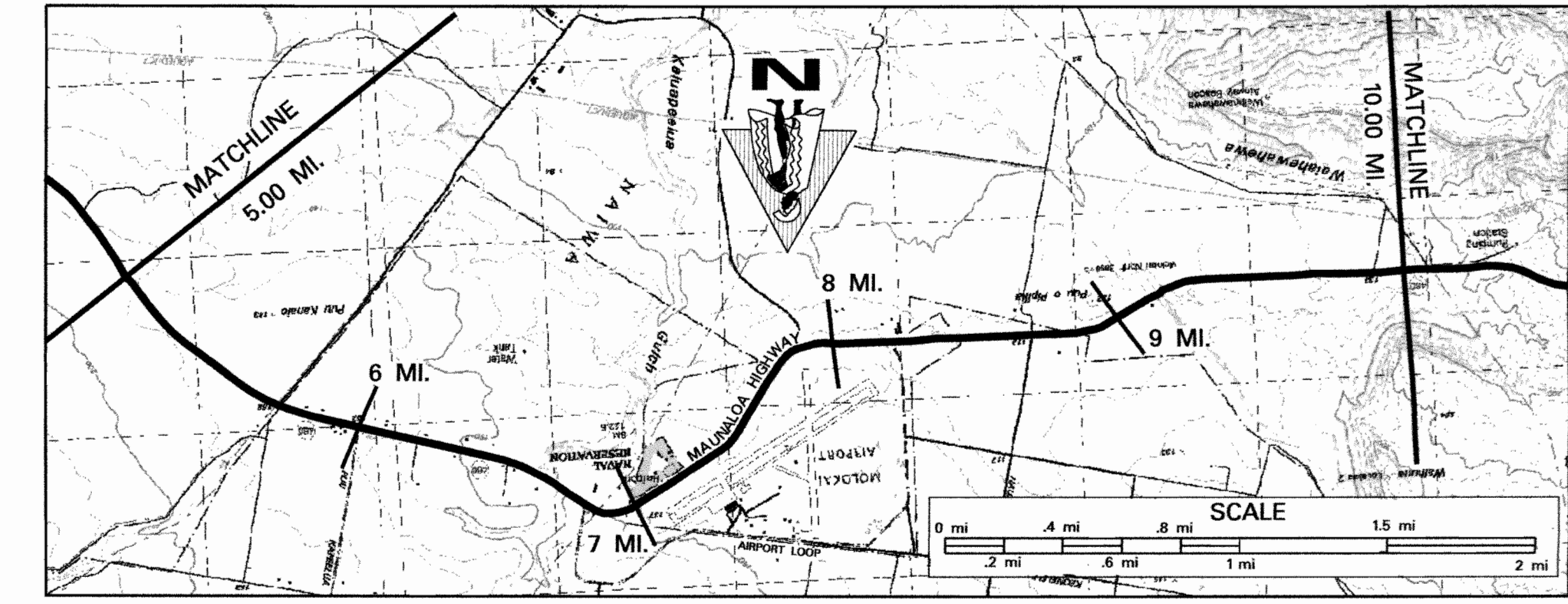
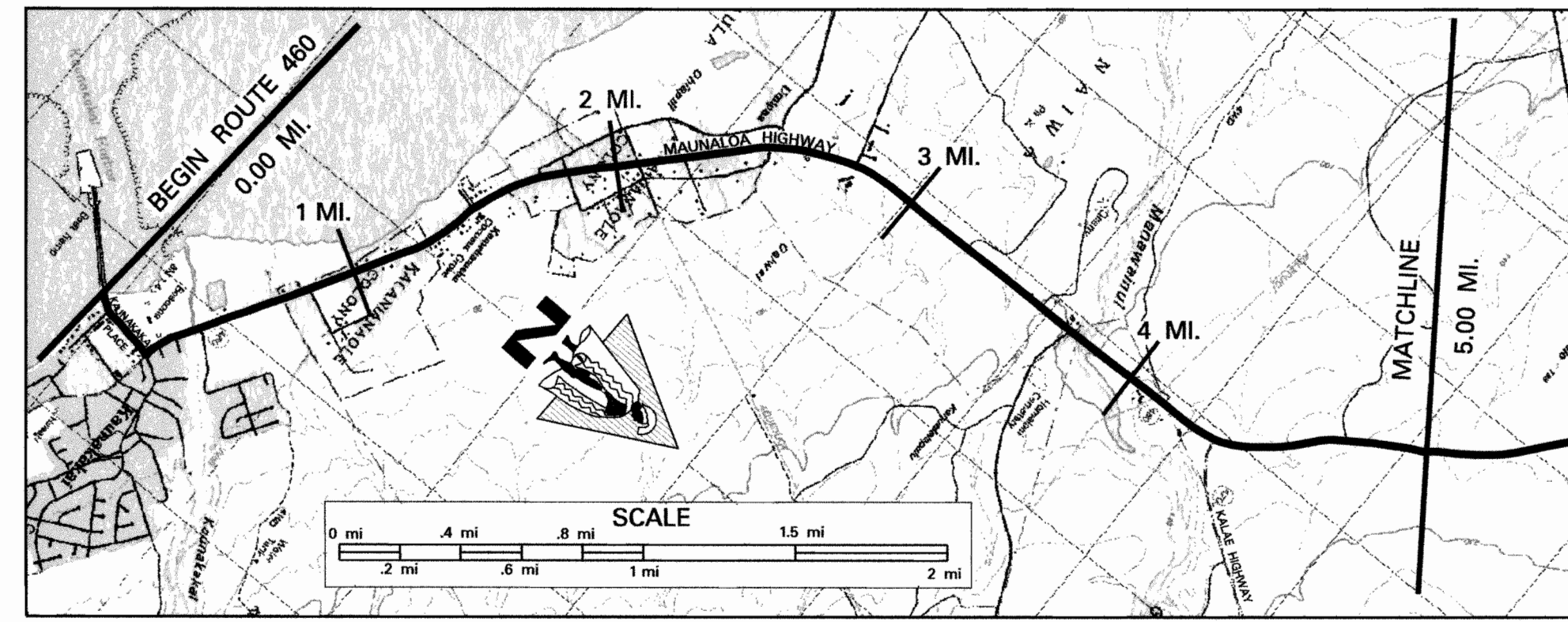

SCALE: (In Miles) 2" = 1 mile

Maintenance Control Sections : Length and Description	0 1 2 3 4 5 6 7 8 9 10										
Structure Carrying Road	<table border="1" style="width: 100%; border-collapse: collapse;"> <tr> <td style="width: 10%;">Bridges (Over 20') : Length, Type, Capacity and Year Constructed</td> <td style="width: 90%;">Culvert 1959 (1971) HS-20 Slab 1954 H-20 Prestressed Conc. Girder 1988, HS-20-44</td> </tr> <tr> <td>Vertical Clearance</td> <td>73' 35' 35' 35' 35' 364'</td> </tr> <tr> <td>Horizontal Clearance</td> <td>136' 36' 36' 36' 36' 41'</td> </tr> <tr> <td>Vertical Clearance</td> <td></td> </tr> <tr> <td>Horizontal Clearance</td> <td></td> </tr> </table>	Bridges (Over 20') : Length, Type, Capacity and Year Constructed	Culvert 1959 (1971) HS-20 Slab 1954 H-20 Prestressed Conc. Girder 1988, HS-20-44	Vertical Clearance	73' 35' 35' 35' 35' 364'	Horizontal Clearance	136' 36' 36' 36' 36' 41'	Vertical Clearance		Horizontal Clearance	
Bridges (Over 20') : Length, Type, Capacity and Year Constructed	Culvert 1959 (1971) HS-20 Slab 1954 H-20 Prestressed Conc. Girder 1988, HS-20-44										
Vertical Clearance	73' 35' 35' 35' 35' 364'										
Horizontal Clearance	136' 36' 36' 36' 36' 41'										
Vertical Clearance											
Horizontal Clearance											
Right of Way Width (min.-max.) if varies	80' 70'-160' 80'-160' 50' 80'-110' 100'										
Available Right of Way Width (Needs Study)											
Right of Way Fence: Type - Right and Left	Residential Area 1000' Clear - Grass, Bushes 10'-15' from Pavement 1000' Clear Pineapple 15'-25' from Pavement Ranch and Pasture Airport 30' Clear 1000' Pineapple/Grass Pasture										
Control of Access: 1-None, 2-Partial, 3-Full	None Wire on Wood 10' from Pavement Wire on Wood 10' from Pavement ChainLink										
Jurisdiction, Transfer Phase No. and Date (C to S or S to C)	State ARR-0460(14), Resurface, 2011 STP-0460(12), Resurface, 1998										
Project No., Type of Construction, and Year Constructed	460A-01-06M, RESURFACE, 2009 ARR-0460(14), Resurface, 2011 STP-0460(12), Resurface, 1998										

Road Diagram

* MP = Milepost Signage

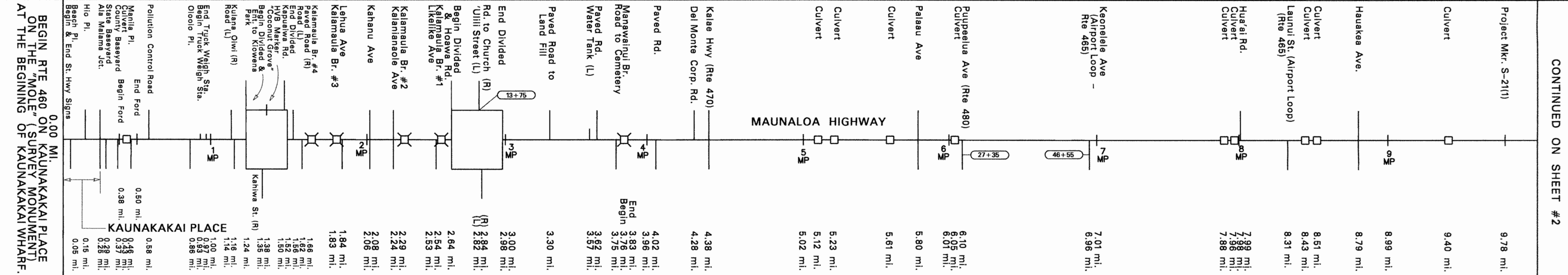
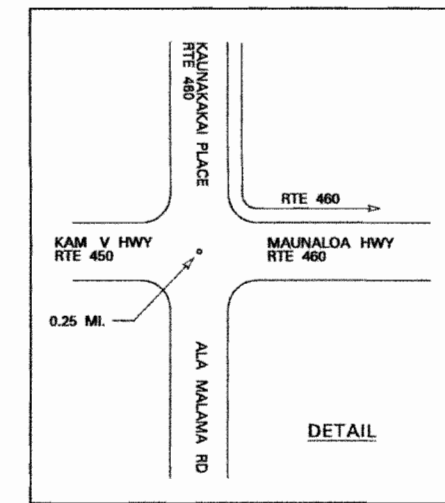
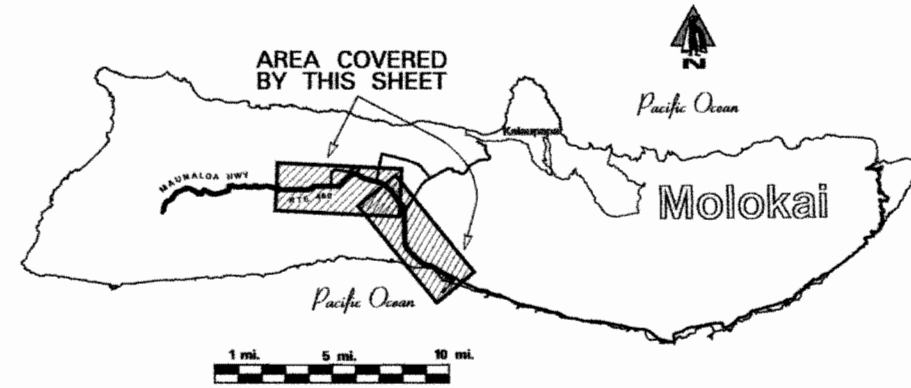

SCALE: (In Miles) 2" = 1 mile

Divided Highway	0 1 2 3 4 5 6 7 8 9 10
Shoulder: Width and Type	24' AC 4' AC 4' AC 4' AC 4' AC 4' AC 4' AC 4' AC 4' AC 4' AC
Pavement: Width and Type	24' AC 4' AC 12' AC 24' AC 12' AC 24' AC 4' AC 8' AC 4' AC 24' AC
Shoulder: Width and Type	4' AC 4' AC 0 4' AC 0 4' AC 4' AC 8' AC 4' AC 4' AC
Median: Width and Type	0 0 12' Painted AC 0 0 0 0 0 0 0
Median Barriers:	0 0 0 0 0 0 0 0 0 0
Shoulder: Width and Type	0 0 12' AC 0 0 0 0 0 0 0
Pavement: Width and Type	0 0 12' AC 0 0 0 0 0 0 0
Shoulder: Width and Type	0 0 4' AC 0 0 0 0 0 0 0
Number of Traffic Lanes	2 2 2 2 2 2 2 2 2 2
Auxiliary Lanes and Parking Lanes: No. of Lanes and Width (Left Side)	0 0 0 0 0 0 0 0 0 0
(Right Side)	0 0 0 0 0 0 0 0 0 0
Frontage Road: No. of Lanes, and Width (Right and Left)	0 0 0 0 0 0 0 0 0 0
Sidewalk: Width and Type (Right and Left)	0 0 0 0 0 0 0 0 0 0
Curb and/or Gutter: Type (Right and Left)	0 0 0 0 0 0 0 0 0 0
Protective Devices: Type, Location and Number	Metal Rails on Metal Posts
Illumination: Type, Location and Number	Mercury Vapor
Curves: Degree of Curvature (Right and Left)	
Superelevation (Range)	
Grades: % Grade, Positive or Negative	0.57 -1 -1.23 1.23 2.32 -1 2.27 3.03 -9 9.30 3.90 4.18 6.07 5.28 6.07 6.35 7.18 -1 7.48 8.51 -1 8.88 9.08 9.46 9.78 -2
Vertical Curve: Crest or Sag, Curve Limits	
Area and Development:	
Terrain: 1-Flat, 2-Rolling, 3-Mountainous	(20 MPH (1)) Flat (1) Rolling (2) Rural (99999) Flat (1)
Speed: 1-Design, 2-Posted	20 MPH (2) 35 MPH (2) 45 MPH (2)
Intersection Control Devices: Type, Location and Cycle Timing	
Traffic Stations (Current Year)	
HPMS Sections - AADT 2011	1,598 6,300 5,790 4,573 2,482 2,100 1,241 910
HPMS Sections - AADT 2010	1,511 6,000 5,600 4,325 2,400 1,900 1,200 880
HPMS Sections - AADT 2009	1,496 5,200 5,800 4,282 2,522 1,839 1,000 980
DOD Sections	
Census Tracts	
Functional Classification	Major Collector (5)
National Highway System (NHS)	Not on NHS (0)
Previous Projects: Project No., Date and Limits	STP-0460(11), 1997 460A-01-90M (Shoulder Paving), 1991 460A-01-91M (Shoulder Paving), 1992 RS-0460(1) Resurface, 1979 F-19(4) 1953, 1954 FAP 19D, 1939 STP-0460(14), Resurface, 2011 RS-0460(08), Resurf., 1987 NRH 34 A(I), 1939 460B-01-83M Resurf., 1983 F-34(2), 1952

SCALE: (In Miles) 2" = 1 mile

Date Released	Revised
Mar. 04, D.B.	
Nov., 06 D.B.	
Aug., 10 D.B.	
Feb. 11 D.B.	
Feb. 12 D.B.	
Sept. 12 E.P.J.	

ROAD INVENTORY

MOLOKAI RTE 460

KAUNAKAKAI PLACE AND MAUNALOA HIGHWAY

STATE OF HAWAII
DEPARTMENT OF TRANSPORTATION
HIGHWAYS DIVISION

PREPARED BY THE
HIGHWAYS PLANNING BRANCH
IN COOPERATION WITH THE
U.S. DEPARTMENT OF TRANSPORTATION
FEDERAL HIGHWAY ADMINISTRATION

Total Route Length: 16.56 miles

a. Survey Length: 16.56 miles

b. Proposed Length: 0.00 miles

c. Other Length: * 0.00 miles

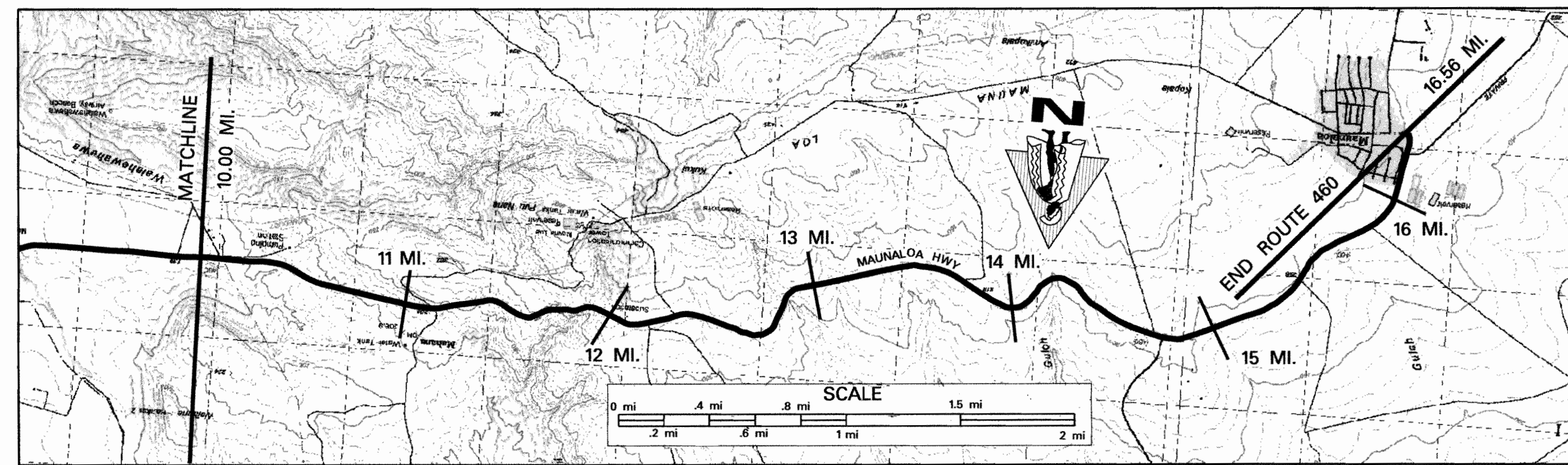

SCALE: (In Miles) 2" = 1 mile

Maintenance Control Sections : Length and Description

Structure Carrying Road

Bridges (Over 20'): Length, Type, Capacity and Year Constructed

Vertical Clearance

Horizontal Clearance

Structure Over Road

Vertical Clearance

Horizontal Clearance

Right of Way Width (min.-max.) if varies

Available Right of Way Width (Needs Study)

Right of Way Fence: Type - Right and Left

Control of Access: 1-None, 2-Partial, 3-Full

Jurisdiction, Transfer Phase No. and Date (C to S or S to C)

Project No., Type of Construction, and Year Constructed

Project No., Type of Construction, and Year Constructed

	10	11	12	13	14	15	16	17	18	19	20
	460 A (16.56 mi.)										End 460 A same as end Rte 460
	80' - 400'										
	1000' Clear - Grass, Bushes, 10'-20' from Pavement										
	None										
	State										
	460A-01-99M, Shldr. Paving, 1992										
	RS-0900(24), Resurface, 1986										

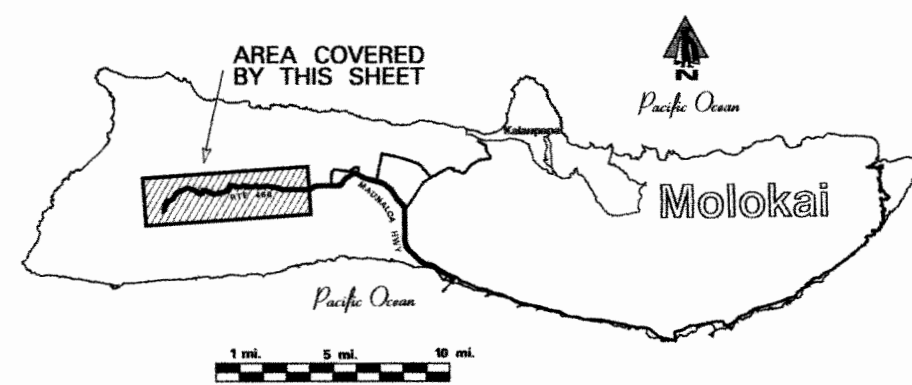

Road Diagram

* MP = Milepost Signage

CONTINUED FROM SHEET #1

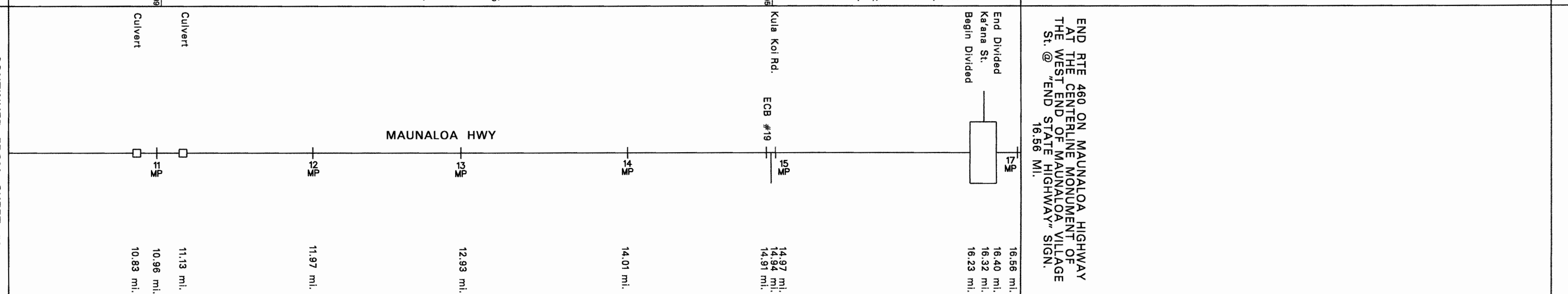

SCALE: (In Miles) 2" = 1 mile

Undivided Highway

Shoulder: Width and Type

Pavement: Width and Type

Shoulder: Width and Type

Median: Width and Type

Median Barriers:

Divided Highway

Shoulder: Width and Type

Pavement: Width and Type

Shoulder: Width and Type

Number of Traffic Lanes

Auxiliary Lanes and Parking Lanes: No. of Lanes and Width (Left Side)

(Right Side)

Frontage Road: No. of Lanes, and Width (Right and Left)

Sidewalk: Width and Type (Right and Left)

Curb and/or Gutter: Type (Right and Left)

All 2' Conc. Gutter unless otherwise noted

Protective Devices: Type, Location and Number

Metal Rails on Concrete Posts unless otherwise noted. M = Metal Rails on Metal Posts

Illumination: Type, Location and Number

Curves: Degree of Curvature (Right and Left)

Superelevation (Range)

Grades: % Grade, Positive or Negative

Vertical Curve: Crest or Sag, Curve Limits

Area and Development:

Terrain: 1-Flat, 2-Rolling, 3-Mountainous

Speed: 1-Design, 2-Posted

Intersection Control Devices: Type, Location and Cycle Timing

Traffic Stations (Current Year)

HPMS Sections - AADT 2011

HPMS Sections - AADT 2010

HPMS Sections - AADT 2009

DOD Sections

Census Tracts

Functional Classification

National Highway System (NHS)

Previous Projects: Project No., Date and Limits

	10	11	12	13	14	15	16	17	18	19	20
	4' AC										
	8' AC										
	4' AC										
	22' AC										
	4' AC										
	10' 8' 15' 10' 8' 9'-15' 14' 0' 11' AC 14' Grv.										
	15' 15' 15' 15' 15' 15' 15' 15' 15' 15' 15' 15'										
	2-11'										
	Rural (99999)										
	Rolling (2)										
	45 MPH (2)										
	(45 MPH (2))										
	(35 MPH (2))										
	875 0460 00831										
	875 0460 01494										
	910										
	693										
	880										
	670										
	980										
	630										
	Major Collector (5)										
	Not on NHS (0)										
	(460A-01-70, Slope Imprv, 1971) (46A-01-71, Resurface, 1971) 460A-01-91M, Shldr. Paving, 1992 14.95										
	460B-01-83M, Resurface, 1983 11.56 11.86 11.99 12.20 RS-0900(24), Resurface, 1986 FAS 21(1), 1949										

SCALE: (In Miles) 2" = 1 mile

Date Released	Mar. 04, D.B.
Revised	
Nov., 06	D.B.
Mar., 09	D.B.
Feb. 11	D.B.
Feb. 12	D.B.
Sept. 12	E.P.J.

ROAD INVENTORY

MOLOKAI RTE 465 AIRPORT LOOP

STATE OF HAWAII
DEPARTMENT OF TRANSPORTATION
HIGHWAYS DIVISION

PREPARED BY THE
HIGHWAYS PLANNING BRANCH
IN COOPERATION WITH THE
U.S. DEPARTMENT OF TRANSPORTATION
FEDERAL HIGHWAY ADMINISTRATION

Total Designated Route Length:	2.13	MILES (a+b)
a. Existing Length:	2.13	MILES
b. Proposed Length:	0.00	MILES
Total Travel Way Length:	2.13	MILES (a+b, less c)
a. Existing Length:	2.13	MILES
b. Temporary Length:	0.00	MILES
c. Length used as T.W. for another Route:	0.00	MILES (-)

NEEDS STUDY ROUTE NO. _____ FUNCTIONAL CLASSIFICATION _____

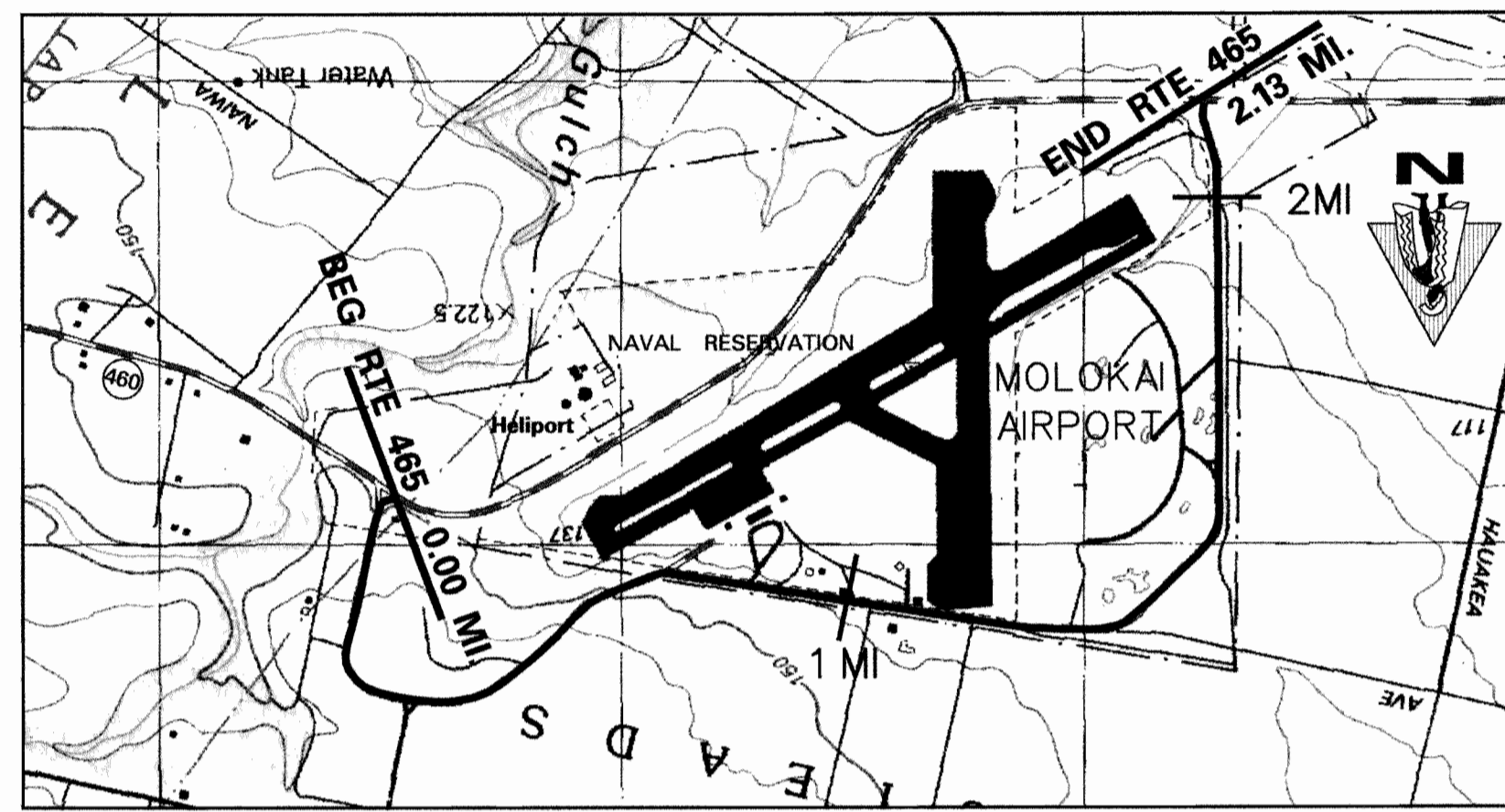

SCALE: (In Miles) 4" = 1 mile

Maintenance Control Sections : Length and Description	0	1	2	3
---	---	---	---	---

Structure Carrying Road	Bridges (Over 20'): Length, Type, Capacity and Year Constructed				
	Vertical Clearance				
	Horizontal Clearance				
Structure Over Road	Vertical Clearance				
	Horizontal Clearance				
	Right of Way Width (min.-max.) if varies				
	Available Right of Way Width (Needs Study)				
	Right of Way Fence: Type - Right and Left				
	Control of Access: 1-None, 2-Partial, 3-Full		NONE		
	Jurisdiction, Transfer Phase No. and Date (C to S or S to C)		COUNTY		
	Project No., Type of Construction, and Year Constructed				
	Project No., Type of Construction, and Year Constructed				

Road Diagram

* MP = Milepost Signage

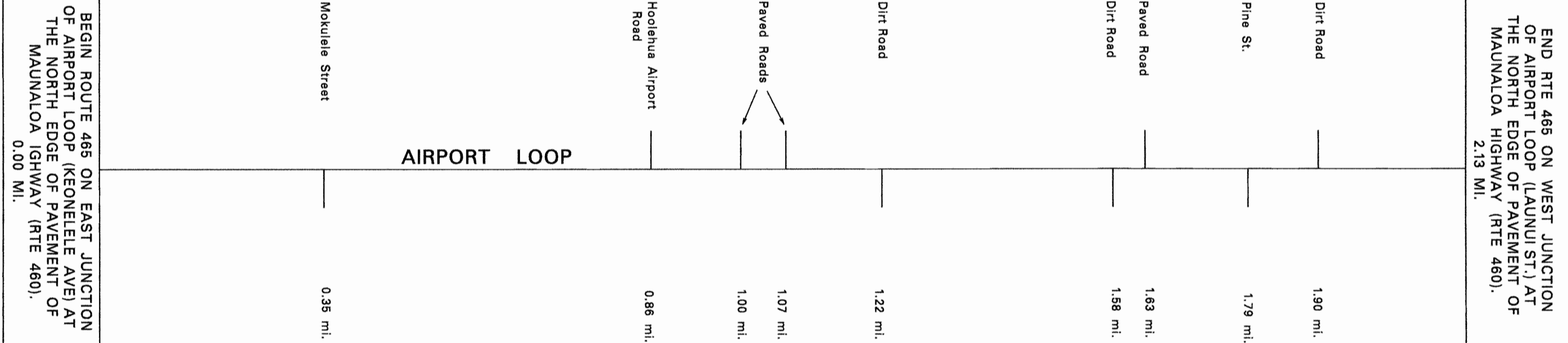

SCALE: (In Miles) 4" = 1 mile

Divided Highway	Shoulder: Width and Type	Dirt / Grass	40'	15'	10'	15'
	Pavement: Width and Type	18' AC	15'	10'	18' BP	10'
	Shoulder: Width and Type	Dirt / Grass	15'	10'	15'	10'
	Median: Width and Type					
	Shoulder: Width and Type					
	Pavement: Width and Type					
	Shoulder: Width and Type					
	Number of Traffic Lanes			2 - 9'		
	Auxiliary Lanes and Parking Lanes: No. of Lanes and Width (Left Side)					
	(Right Side)					
	Frontage Road: No. of Lanes, and Width (Right and Left)					
	Sidewalk: Width and Type (Right and Left)					
	Curb and/or Gutter: Type (Right and Left)					
	Protective Devices: Type, Location and Number					
	Illumination: Type, Location and Number					
	Curves: Degree of Curvature (Right and Left)					
	Superelevation (Range)					
	Grades: % Grade, Positive or Negative					
	Vertical Curve: Crest or Sag, Curve Limits					
	Area and Development:			Rural (99999)		
	Terrain: 1-Flat, 2-Rolling, 3-Mountainous			Rolling (2)		
	Speed: 1-Design, 2-Posted			30 MPH		
	Intersection Control Devices: Type, Location and Cycle Timing					
	Traffic Stations (Current Year)	875 0465 00000	875 0465 00035	875 0465 00066		
	HPMS Sections - AADT 2011	641	910	180		
	HPMS Sections - AADT 2010	620	710	170		
	HPMS Sections - AADT 2009	650	910	260	213	
	DOD Sections					
	Census Tracts					
	Functional Classification			Major Collector (5)		
	National Highway System (NHS)			Not on NHS (0)		
	Previous Projects: Project No., Date and Limits					

SCALE: (In Miles) 4" = 1 mile

Maintenance Control Sections : Length and Description	0	1	2	3
---	---	---	---	---

Date Released	Revised
Jun 2002, JK	
Nov. 06 D.B.	
Dec. 09 D.B.	
Feb. 11 D.B.	
Feb. 12 D.B.	
Sept. 12 E.P.J.	

ROAD INVENTORY MOLOKAI RTE 470 KALAE HIGHWAY

STATE OF HAWAII
DEPARTMENT OF TRANSPORTATION
HIGHWAYS DIVISION
PREPARED BY THE
HIGHWAYS PLANNING BRANCH
IN COOPERATION WITH THE
U.S. DEPARTMENT OF TRANSPORTATION
FEDERAL HIGHWAY ADMINISTRATION

Total Route Length: 5.79 miles
a. Survey Length: 5.79 miles
b. Proposed Length: 0.00 miles
c. Other Length: * 0.00 miles

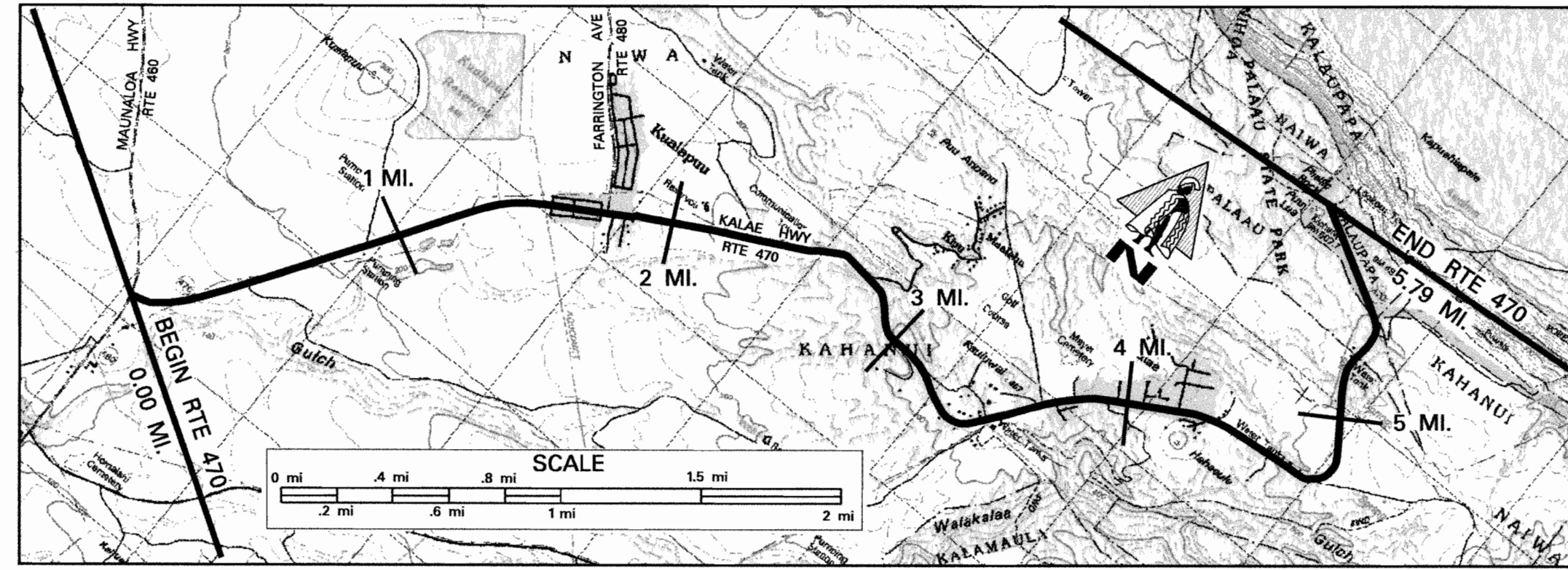

SCALE: (In Miles) 2" = 1 mile

Maintenance Control Sections : Length and Description

Begin 470A same as begin route	470A (5.79 MI.)	End 470A same as end route.
--------------------------------	-----------------	-----------------------------

Structure Carrying Road

Bridges (Over 20'): Length, Type, Capacity and Year Constructed

Vertical Clearance

Horizontal Clearance

Structure Over Road

Vertical Clearance

Horizontal Clearance

Right of Way Width (min.-max.) if varies

Available Right of Way Width (Needs Study)

Right of Way Fence: Type - Right and Left

Control of Access: 1-None, 2-Partial, 3-Full

Jurisdiction, Transfer Phase No. and Date (C to S or S to C)

Project No., Type of Construction, and Year Constructed

Project No., Type of Construction, and Year Constructed

Road Diagram

* MP = Milepost Signage

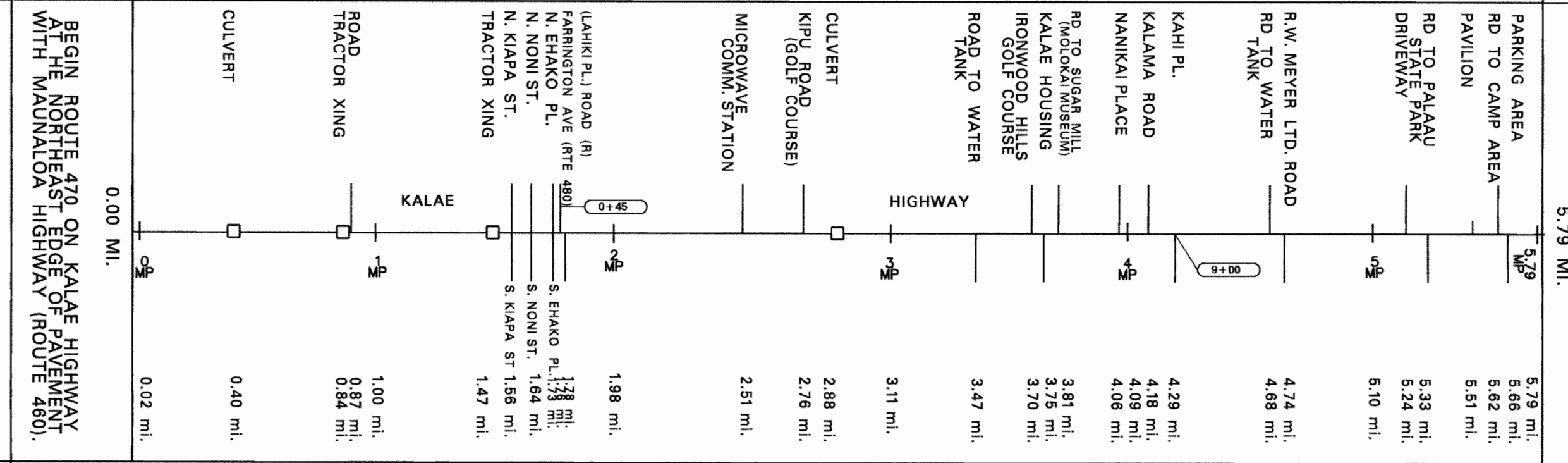

SCALE: (In Miles) 2" = 1 mile

Divided Highway

Shoulder: Width and Type

Pavement: Width and Type

Shoulder: Width and Type

Median: Width and Type

Shoulder: Width and Type

Pavement: Width and Type

Shoulder: Width and Type

Number of Traffic Lanes

Auxiliary Lanes and Parking Lanes: No. of Lanes and Width (Left Side)

(Right Side)

Frontage Road: No. of Lanes, and Width (Right and Left)

Sidewalk: Width and Type (Right and Left)

Curb and/or Gutter: Type (Right and Left)

Protective Devices: Type, Location and Number

ILLUMINATION: Type, Location and Number

Curves: Degree of Curvature (Right and Left)

Superelevation (Range)

Grades: % Grade, Positive or Negative

Vertical Curve: Crest or Sag, Curve Limits

Area and Development:

Terrain: 1-Flat, 2-Rolling, 3-Mountainous

Speed: 1-Design, 2-Posted

Intersection Control Devices: Type, Location and Cycle Timing

Traffic Stations (Current Year)

HPMS Sections - AADT 2011

HPMS Sections - AADT 2010

HPMS Sections - AADT 2009

DOD Sections

Census Tracts

Functional Classification

National Highway System (NHS)

Previous Projects: Project No., Date and Limits

SCALE: (In Miles) 2" = 1 mile

Date Released	Oct 2004 GN
Revised	Nov., 06 D.B. Feb. 11 D.B. Feb. 12 D.B. Sept. 12 E.P.J.

ROAD INVENTORY

MOLOKAI RTE 480

FARRINGTON AVE. – PUUPEELUA AVE.

STATE OF HAWAII
DEPARTMENT OF TRANSPORTATION
HIGHWAYS DIVISION

PREPARED BY THE
HIGHWAYS PLANNING BRANCH
IN COOPERATION WITH THE
U.S. DEPARTMENT OF TRANSPORTATION
FEDERAL HIGHWAY ADMINISTRATION

Total Route Length: 3.66 miles

a. Survey Length: 3.66 miles

b. Proposed Length: 0.00 miles

c. Other Length: * 0.00 miles

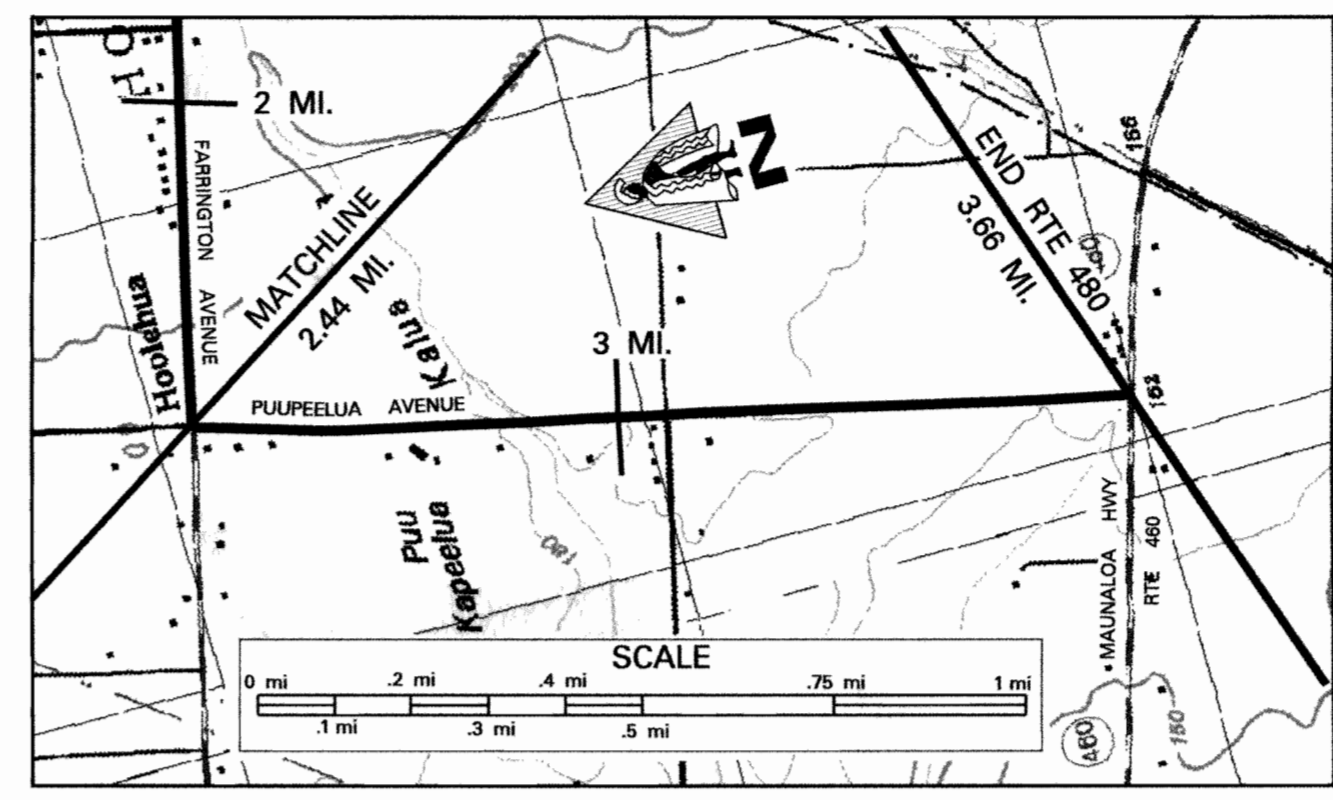
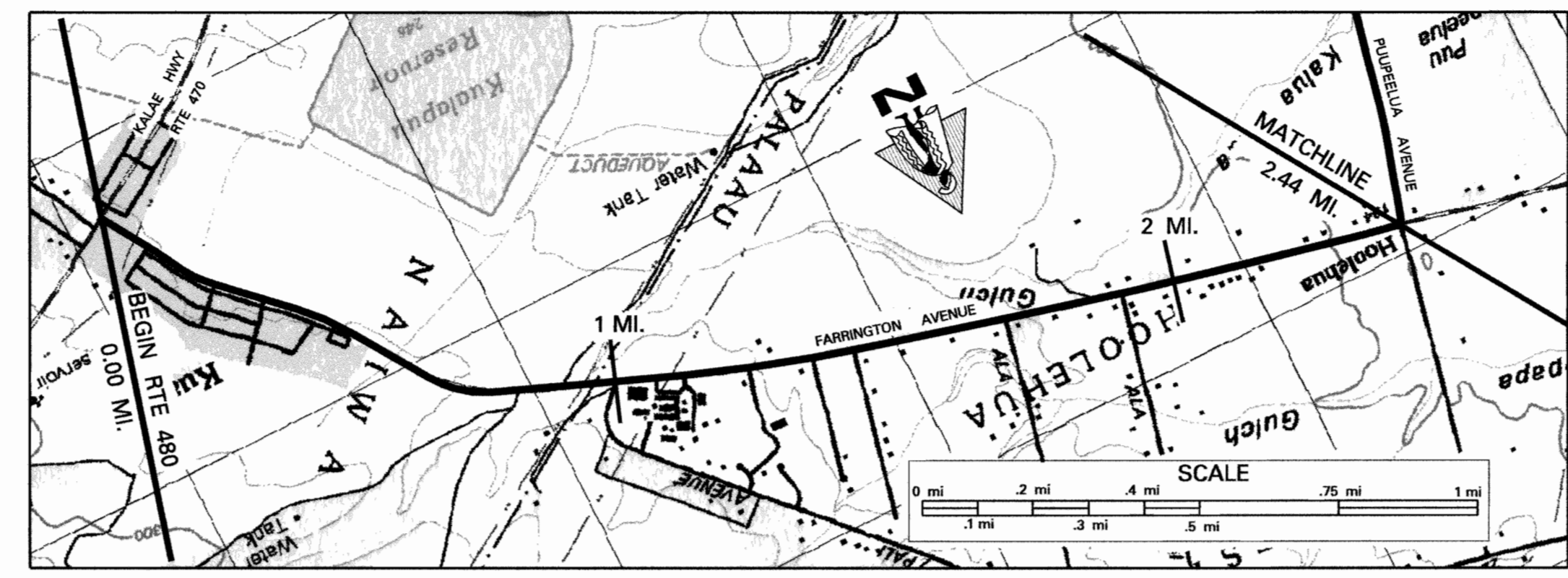

SCALE: (In Miles) 4" = 1 mile

Maintenance Control Sections : Length and Description	Begin 480 on Farrington Avenue 16' West of the Northwest edge of pavement of Kalea Highway.	480A (3.65 MI.)		End 480A on Puupeeelua Avenue 50' North of North edge of pavement of Maunaloa Highway.
--	---	-----------------	--	--

Structure Carrying Road	Bridges (Over 20'): Length, Type, Capacity and Year Constructed			
	Vertical Clearance			
Structure Over Road	Horizontal Clearance			
	Vertical Clearance			
Right of Way Width (min.-max.) if varies				
Available Right of Way Width (Needs Study)				
Right of Way Fence: Type - Right and Left				
Control of Access: 1-None, 2-Partial, 3-Full				
Jurisdiction, Transfer Phase No. and Date (C to S or S to C)				
Project No., Type of Construction, and Year Constructed				
Project No., Type of Construction, and Year Constructed				

Road Diagram

• MP = Milepost Signage

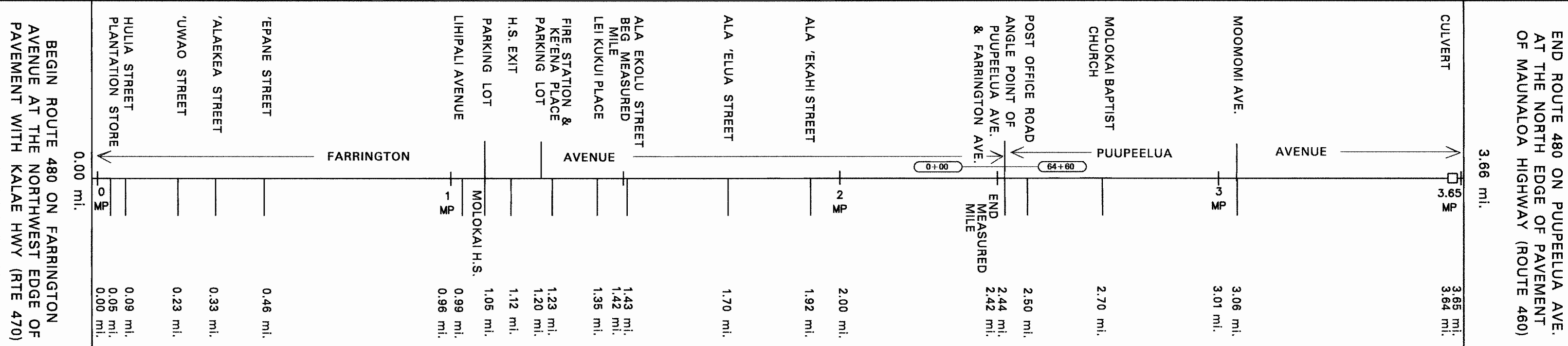

SCALE: (In Miles) 4" = 1 mile

Divided Highway	Shoulder: Width and Type			
	Pavement: Width and Type	24' AC		
	Shoulder: Width and Type	6' AC		
	Median: Width and Type			
	Shoulder: Width and Type			
	Pavement: Width and Type			
Shoulder: Width and Type				
Number of Traffic Lanes				
Auxiliary Lanes and Parking Lanes: No. of Lanes and Width (Left Side)				
(Right Side)				
Frontage Road: No. of Lanes, and Width (Right and Left)				
Sidewalk: Width and Type (Right and Left)				
Curb and/or Gutter: Type (Right and Left)				
Protective Devices: Type, Location and Number				
Illumination: Type, Location and Number				
Curves: Degree of Curvature (Right and Left)				
Superelevation (Range)				
Grades: % Grade, Positive or Negative				
Vertical Curve: Crest or Sag, Curve Limits				
Area and Development:				
Terrain: 1-Flat, 2-Rolling, 3-Mountainous				
Speed: 1-Design, 2-Posted				
Intersection Control Devices: Type, Location and Cycle Timing				
Traffic Stations (Current Year)				
HPMS Sections - AADT 2011				
HPMS Sections - AADT 2010				
HPMS Sections - AADT 2009				
DOD Sections				
Census Tracts				
Functional Classification				
National Highway System (NHS)				
Previous Projects: Project No., Date and Limits				

SCALE: (In Miles) 4" = 1 mile

Date Released	
Revised	
Oct 2004 GN	
Feb. 06 D.B.	
Nov. 06 D.B.	
Feb. 11 D.B.	
Feb. 12 D.B.	
Sept. 12 E.P.J.	

ROAD INVENTORY LANAI RTE. 440 KAUMALAPAU HWY., MANELE RD.

STATE OF HAWAII
DEPARTMENT OF TRANSPORTATION
HIGHWAYS DIVISION

PREPARED BY THE
HIGHWAYS PLANNING BRANCH
IN COOPERATION WITH THE
U.S. DEPARTMENT OF TRANSPORTATION
FEDERAL HIGHWAY ADMINISTRATION

* ROUTE LENGTH	=	13.68 mi.
AIRPORT SPUR	=	0.47 mi.
LANAI CITY SPUR	=	0.03 mi.
TOTAL	=	13.68 mi.

Total Designated Route Length:	13.68 *	MILES (a+b)
a. Existing Length:	13.68 *	MILES
b. Proposed Length:	NONE	MILES
Total Travel Way Length:	13.68 *	MILES (a+b, less c)
a. Existing Length:	13.68 *	MILES
b. Temporary Length:	NONE	MILES
c. Length used as T.W. for another Route:	NONE	MILES (-)

NEEDS STUDY ROUTE NO. _____ FUNCTIONAL CLASSIFICATION _____

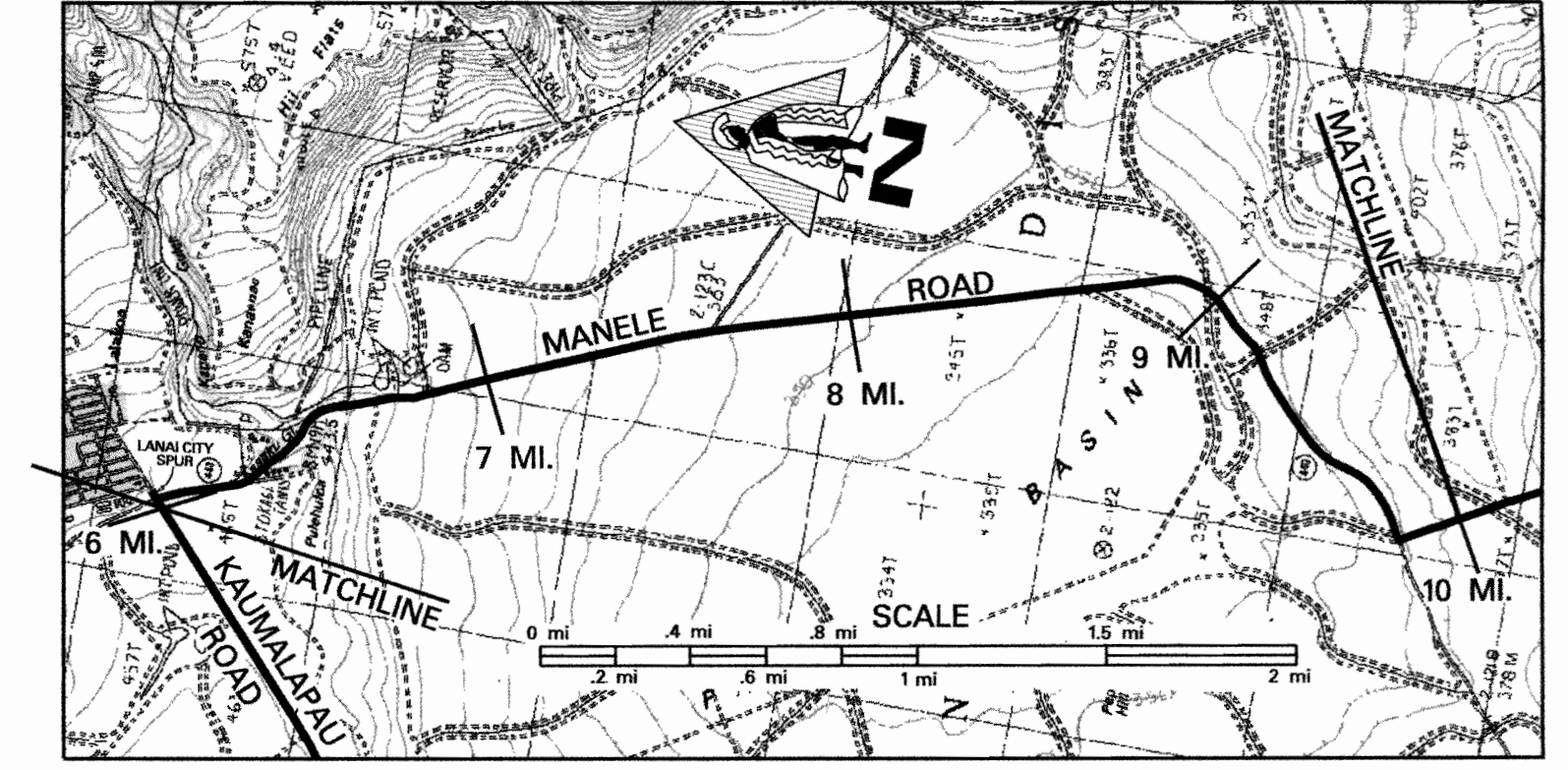
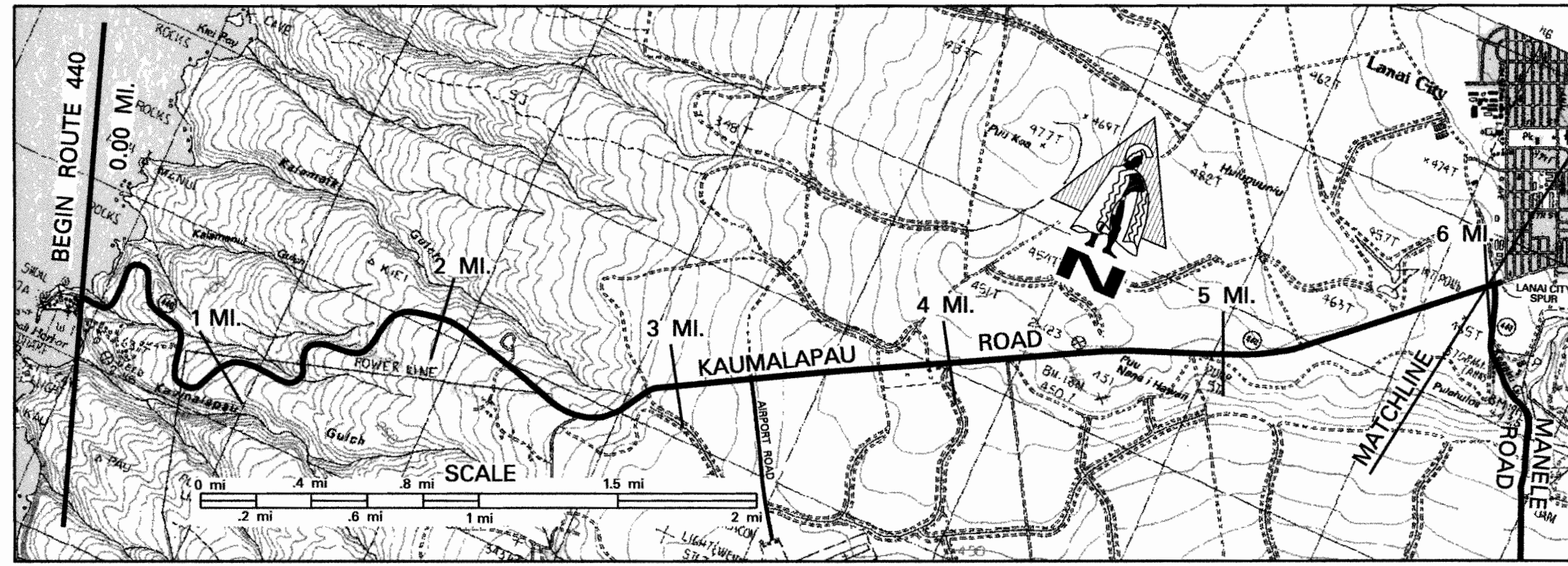

Maintenance Control Sections : Length and Description	0 Beg. 440 A Same as Begin Route	1 440A (5.97 mi.) * * Does not include Airport Spur (see sht. 2) or Kaumalapu Hwy northeast of Manele Rd. (see diagram below)	2	3	4	5	6 End 440 A On Kaumalapu Hwy 150' northeast of centerline intersection with Manele Rd.	7	8	9	10 Begin 440 B On Manele Road at southeast edge of pavement of Kaumalapu Hwy	11 440B (7.21 mi.)
---	----------------------------------	---	---	---	---	---	--	---	---	---	--	--------------------

Structure Carrying Road	Bridges (Over 20'): Length, Type, Capacity and Year Constructed	
	Vertical Clearance	
Structure Over Road	Horizontal Clearance	
	Vertical Clearance	
	Horizontal Clearance	
	Right of Way Width (min.-max.) if varies	90' - 200' 80' - 130' 100' 80' - 150' 30'
	Available Right of Way Width (Needs Study)	Clear 1000' Pineapple Fields / Bushes, Small Trees 15' - 25' From Edge of Pavement
	Right of Way Fence: Type - Right and Left	NONE
	Control of Access: 1-None, 2-Partial, 3-Full	NONE
	Jurisdiction, Transfer Phase No. and Date (C to S or S to C)	STATE (440A-01-92M, (R), 1992)
	Project No., Type of Construction, and Year Constructed	440A-01-10M, PREV. MAINT., 2011 (440A-01-99M, Resurf, 2009) HWY - M - 02 - 97M, Shldr. Paving, 1998 440A-01-03M, Resurf, 2005 440A-01-02M, (R) 2003 440A-01-01M, (R), 2004 440A-01-96M, 1997 440A-01-07M, Resurf., 2008 STP - 0440(1) Resurf. Worksite #1 1996 440B 01 - 98M 1999 (Resurf.) 440B - 02 - 98M, 'R', '99 (440B-01-04M, Resurf., 2005) STP-0440 (5), 1995 (Resurfacing & Improvements)
	Project No., Type of Construction, and Year Constructed	

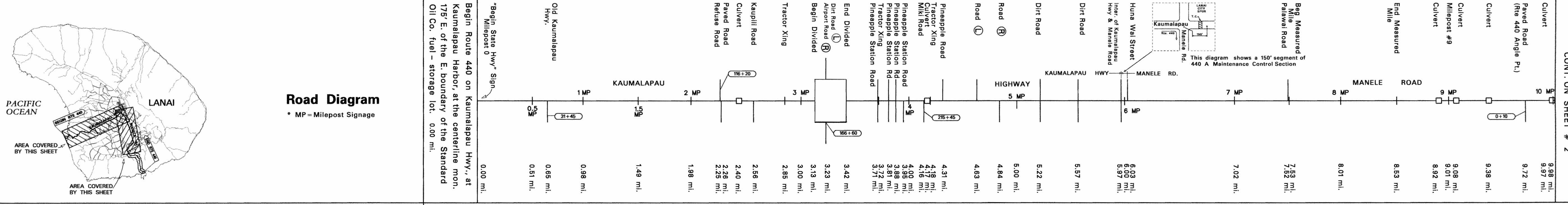

Divided Highway	Shoulder: Width and Type	ALL SHOULDERS GRASS EXCEPT WHERE OTHERWISE INDICATED
	Pavement: Width and Type	6' AC 24' AC 12' AC 24' AC 2' AC 20' AC
	Shoulder: Width and Type	ALL SHOULDERS GRASS EXCEPT WHERE OTHERWISE INDICATED
	Median: Width and Type	6' AC 0 6' AC 12' PAINTED AC 0 6' AC
	Shoulder: Width and Type	6' AC 0 6' AC 12' AC 6' AC

Number of Traffic Lanes	2-12'	2-10'
Auxiliary Lanes and Parking Lanes: No. of Lanes and Width (Left Side)		
(Right Side)		
Frontage Road: No. of Lanes, and Width (Right and Left)		
Sidewalk: Width and Type (Right and Left)		
Curb and/or Gutter: Type (Right and Left)	GUTTERS	
Protective Devices: Type, Location and Number		
Illumination: Type, Location and Number		
Curves: Degree of Curvature (Right and Left)		
Superelevation (Range)		
Grades: % Grade, Positive or Negative		
Vertical Curve: Crest or Sag, Curve Limits		
Area and Development:		
Terrain: 1-Flat, 2-Rolling, 3-Mountainous	MOUNTAINOUS (3) ROLLING (2) FLAT (1)	RURAL (99999)
Speed: 1-Design, 2-Posted	30 MPH 45 MPH	35 MPH

Intersection Control Devices: Type, Location and Cycle Timing				
Traffic Stations (Current Year)	B76 0440 00000	B76 0440 00323	B76 0440 00597	B76 0440 00656 (B76 0440 00972) ←
HPMS Sections - AADT 2011	144	590	1,300	866
HPMS Sections - AADT 2010	167	899	2,390	819
HPMS Sections - AADT 2009	165	890	2,366	811
DOD Sections				COUNTY
Census Tracts				
Functional Classification			MAJOR COLLECTOR (5)	
National Highway System (NHS)			NOT ON NHS (0)	
Previous Projects: Project No., Date and Limits	0.62 HWY - M - 02 - 97M, Shldr. Paving, 1998 2.06 440A-01-03M, Resurf, 2005 3.12 3.41	2.06 440A-01-99M, Resurf, 2009 1.80 440A-01-90M, Shldr. Paving, 1998 3.26 3.43 440A-01-96M, 1997 4.99	4.99 STP-0440(1) Resurf. Worksite #1 1996 5.97 440B-01-98M (R) 1997 6.61	6.61 STP-0440(5) 1995 (Resurfacing & Improvements) COUNTY

SCALE: (In Miles) 2" = 1 mile

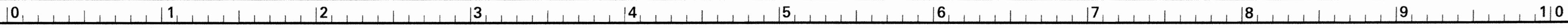

Date Released	Dec. 2002 T.S.
Revised	
Feb. 04	D.B.
Aug. 04	D.B.
Feb. 06	D.B.
Nov. 06	D.B.
Mar. 08	D.B.
Mar. 09	D.B.
Feb. 11	D.B.
Feb. 12	D.B.
Sept. 12	E.P.J.

ROAD INVENTORY

LANAI RTE. 440

MANELE ROAD, AIRPORT ROAD

STATE OF HAWAII
DEPARTMENT OF TRANSPORTATION
HIGHWAYS DIVISION

PREPARED BY THE
HIGHWAYS PLANNING BRANCH
IN COOPERATION WITH THE
U.S. DEPARTMENT OF TRANSPORTATION
FEDERAL HIGHWAY ADMINISTRATION

* ROUTE LENGTH	=	13.18 mi.
AIRPORT SPUR	=	0.47 mi.
LANAI CITY SPUR	=	0.03 mi.
TOTAL	=	13.68 mi.

Total Designated Route Length:	13.68 *	MILES (a+b)
a. Existing Length:	13.68 *	MILES
b. Proposed Length:	NONE	MILES
Total Travel Way Length:	13.68 *	MILES (a+b, less c)
a. Existing Length:	13.68 *	MILES
b. Temporary Length:	NONE	MILES
c. Length used as T.W. for another Route:	NONE	MILES (-)

NEEDS STUDY ROUTE NO. _____ FUNCTIONAL CLASSIFICATION _____

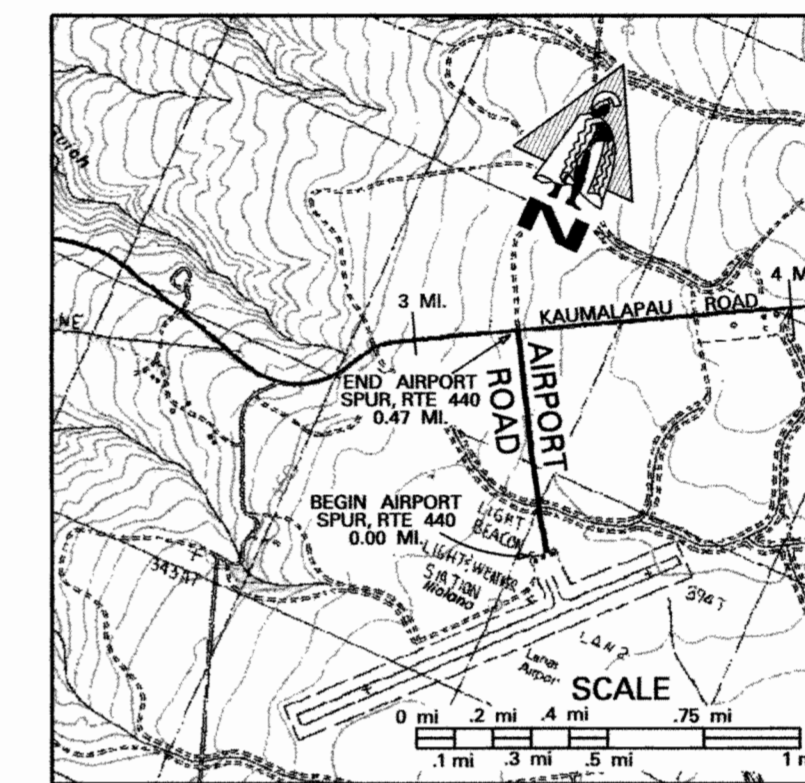
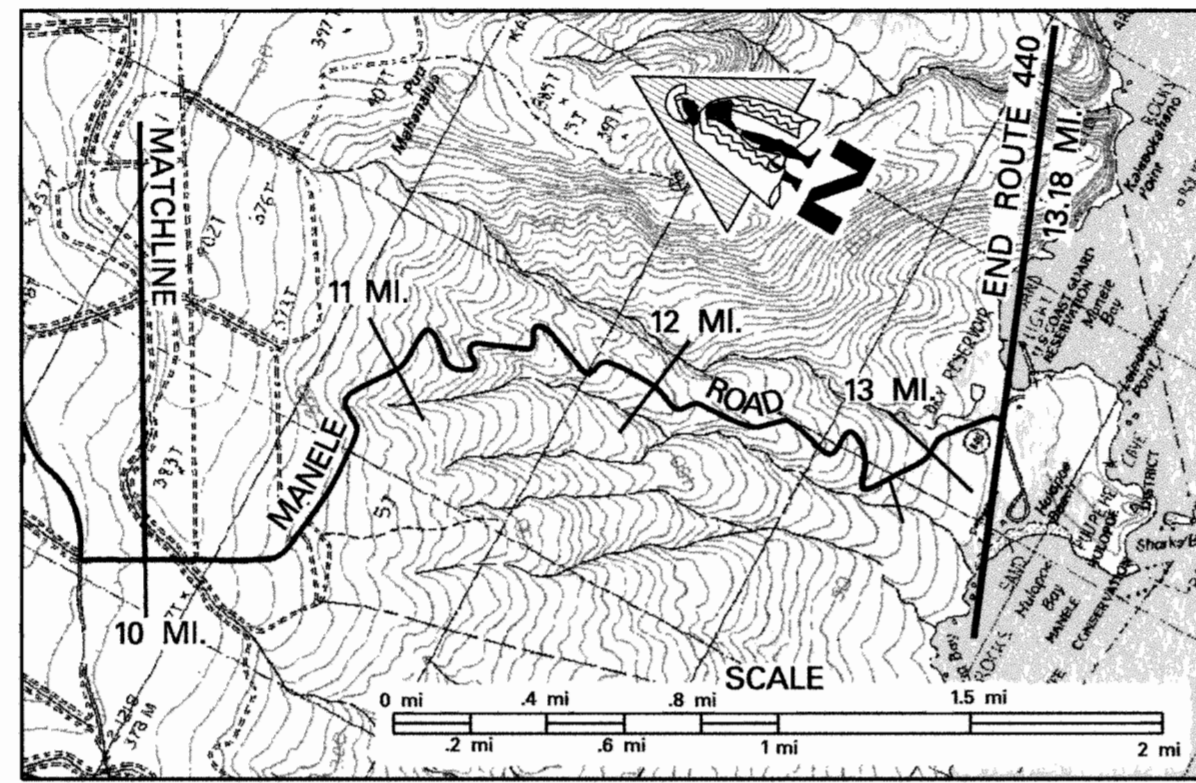

SCALE: (In Miles) 2" = 1 mile

Maintenance Control Sections : Length and Description	10	11	12	13	14	15	0	50	0	0.10
			440B (7.21 mi.)	End 440 B Same as End Route	440A (0.57 mi.)	End 440 A Same as End Airport Road (Spur)				
Structure Carrying Road	Bridges (Over 20'): Length, Type, Capacity and Year Constructed									
	NONE									
	Vertical Clearance									
	Horizontal Clearance									
Structure Over Road	Vertical Clearance									
	Horizontal Clearance									
	Right of Way Width (min.-max.) if varies									
	Available Right of Way Width (Needs Study)									
	Right of Way Fence: Type - Right and Left									
	Control of Access: 1-None, 2-Partial, 3-Full									
	Jurisdiction, Transfer Phase No. and Date (C to S or S to C)									
	Project No., Type of Construction, and Year Constructed									
	Project No., Type of Construction, and Year Constructed									

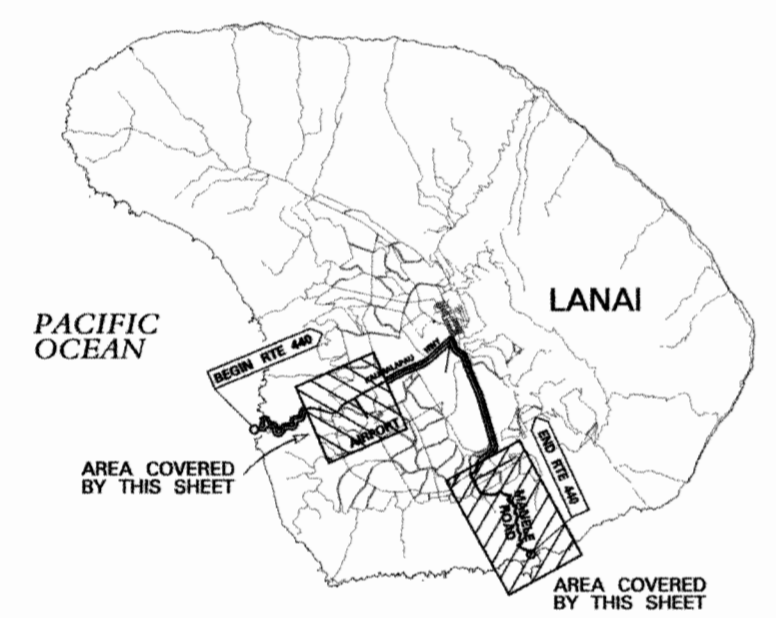

Road Diagram
* MP = Milepost Signage

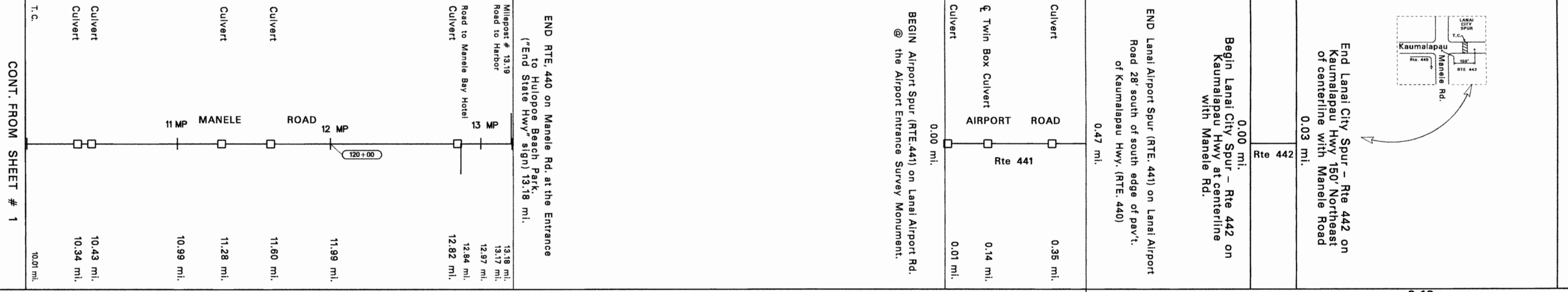

SCALE: (In Miles) 2" = 1 mile

Shoulder: Width and Type	10	11	12	13	14	0	50	0	0.10	
	25' Dirt	25' Dirt	25' Dirt	25' Dirt	25' Dirt	All Gravel	6' AC	6'		
Pavement: Width and Type	ALL SHOULDERS GRASS EXCEPT WHERE OTHERWISE INDICATED									
	25' Dirt	25' Dirt	25' Dirt	25' Dirt	25' Dirt	All Gravel	20' AC	3'		
Median: Width and Type	ALL SHOULDERS GRASS EXCEPT WHERE OTHERWISE INDICATED									
	25' Dirt	25' Dirt	25' Dirt	25' Dirt	25' Dirt	All Gravel	6'-12'			
Number of Traffic Lanes	2-10'									
Auxiliary Lanes and Parking Lanes: No. of Lanes and Width (Left Side)										
(Right Side)										
Frontage Road: No. of Lanes, and Width (Right and Left)	NONE									
Sidewalk: Width and Type (Right and Left)	NONE									
Curb and/or Gutter: Type (Right and Left)	NONE									
Protective Devices: Type, Location and Number	NONE									
Illumination: Type, Location and Number	NONE									
Curves: Degree of Curvature (Right and Left)										
Superelevation (Range)										
Grades: % Grade, Positive or Negative										
Vertical Curve: Crest or Sag, Curve Limits										
Area and Development:	RURAL (99999)									
Terrain: 1-Flat, 2-Rolling, 3-Mountainous	FLAT (1)	MOUNTAINOUS (3)	FLAT (1)	FLAT (1)	FLAT (1)	FLAT (1)	FLAT (1)	FLAT (1)	FLAT (1)	
Speed: 1-Design, 2-Posted	35 MPH (2)	25 MPH (2)	25 MPH (2)	25 MPH (2)	25 MPH (2)	NOT POSTED	15 MPH (2)	15 MPH (2)	15 MPH (2)	
Intersection Control Devices: Type, Location and Cycle Timing										
Traffic Stations (Current Year)	876 0440 00072	876 0440 01061	876 0440 01176	876 0440 01262	876 0440 01348	876 0441 00000	876 0442 00000	876 0442 00000	876 0442 00000	
HPMS Sections - AADT 2011	866	866	1,137	455	455	414	2,999	414	2,999	
HPMS Sections - AADT 2010	819	819	1,100	440	440	400	2,900	400	2,900	
HPMS Sections - AADT 2009	811	811	610	610	610	380	2,900	380	2,900	
DOD Sections										
Census Tracts										
Functional Classification	COUNTY									
	MAJOR COLLECTOR (5)									
National Highway System (NHS)	NOT ON NHS (0)									
Previous Projects: Project No., Date and Limits	440A - 01 - 92M(R) 1992									
	440B - 01 - 82M(R) 1982									
	440B - 01 - 83M(R) 1983									
	S - 0440(1) 1959									

SCALE: (In Miles) 2" = 1 mile

Date Released	Dec 2002, T.S.
Revised	
Feb. 04	D.B.
Aug. 04	D.B.
Feb. 06	D.B.
Nov. 06	D.B.
Feb. 08	D.B.
Mar. 09	D.B.
Feb. 11	D.B.
Feb. 12	D.B.
Sept. 12	E.P.J.